

Data Sheet

Features

- For wireless applications
- Usable bandwidth of 20 MHz
- High attenuation
- Single-ended operation at 50Ω
- Ceramic Surface Mount Package (SMP)

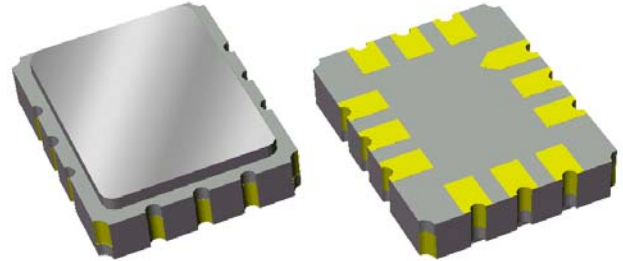

Package

Surface Mount 7.01 x 5.51 x 1.63 mm

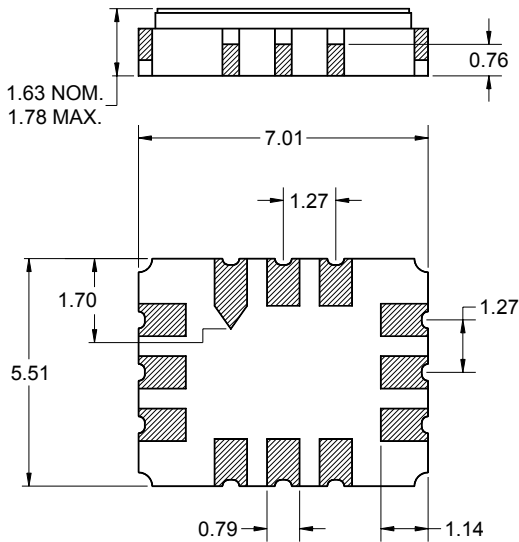

Pin Configuration

Bottom View

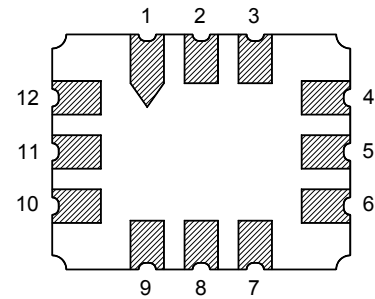

Pin No.	Description
3	Output
9	Input
8,2	NC
1,4,5,6,7	Case Ground
10,11,12	Case Ground

Dimensions shown are nominal in millimeters
 All tolerances are ± 0.15 mm except overall
 length and width ± 0.13 mm

Body: Al_2O_3 ceramic
 Lid: Kovar, Ni plated
 Terminations: Au plating 0.5 - 1.0 μ m,
 over a 2 - 6 μ m Ni plating

Data Sheet

Electrical Specifications ⁽¹⁾

Operating Temperature: ⁽²⁾ +25 °C

Parameter ⁽³⁾	Minimum	Typical	Maximum	Unit
Center Frequency	479.25	479.75	480.25	MHz
Insertion Loss	-	9.8	13	dB
1 dB Bandwidth	-	23.3	-	MHz
3 dB Bandwidth	23	25.5	-	MHz
30 dB Bandwidth	-	33	-	MHz
35 dB Bandwidth	-	33.9	36	MHz
Passband Variation	-	0.75	1.5	dB p-p
Group Delay Variation	-	25	50	nsec
Source Impedance ⁽⁴⁾	-	50	-	Ω
Load Impedance ⁽⁴⁾	-	50	-	Ω
Temperature Coefficient of Frequency	-	-90	-	ppm/°C

Notes:

1. All specifications are based on the test circuit shown below
2. This specification is valid for room temperature only
3. Electrical margin has been built into the design to account for the variations due to manufacturing tolerances
4. This is the optimum impedance in order to achieve the performance shown

Test Circuit:

Actual matching values may vary due to PCB layout and parasitics

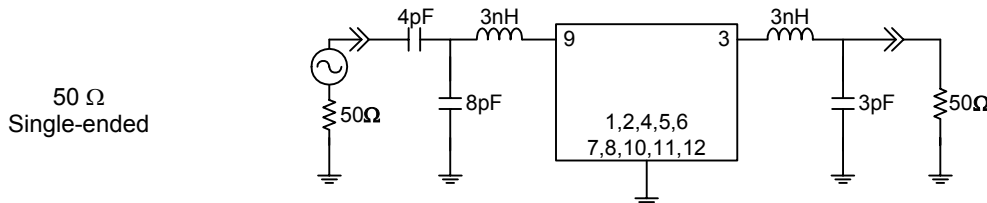

Data Sheet

Typical Performance (at +25°C)

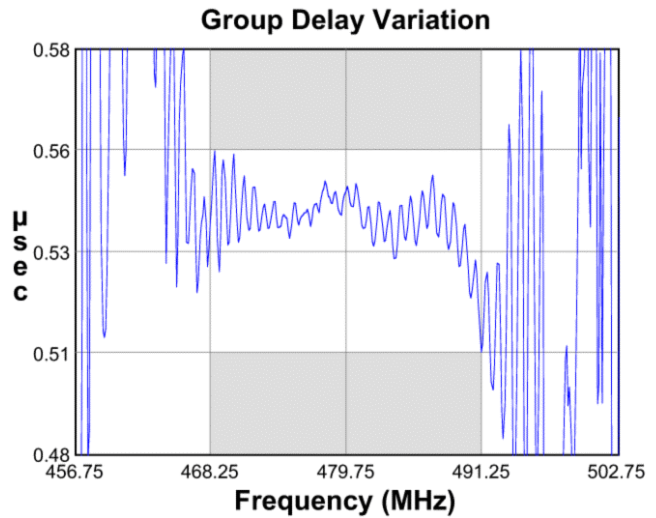
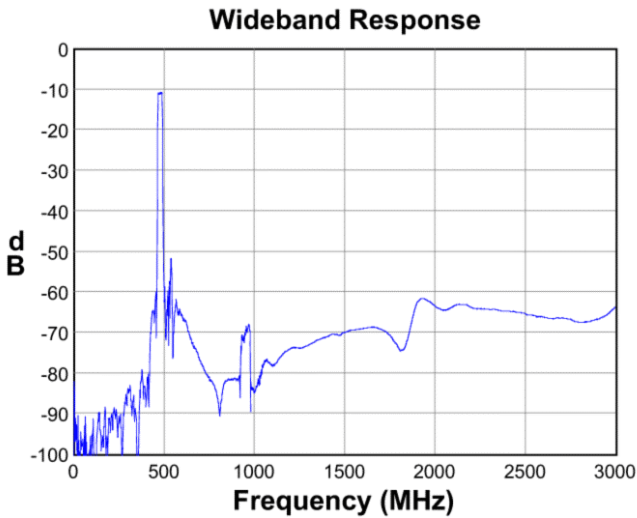
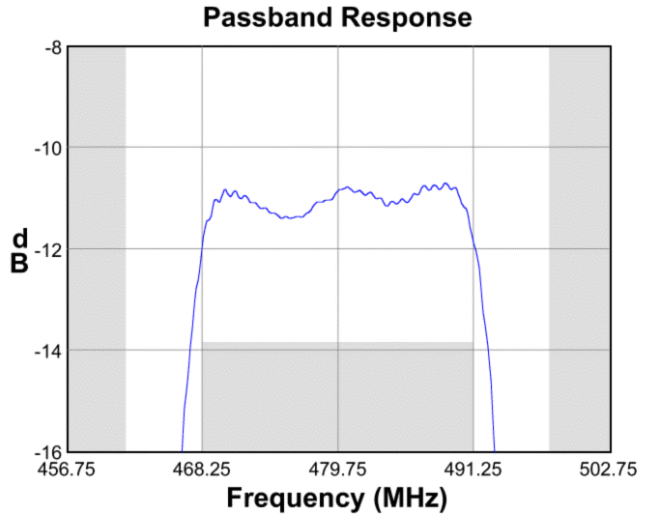
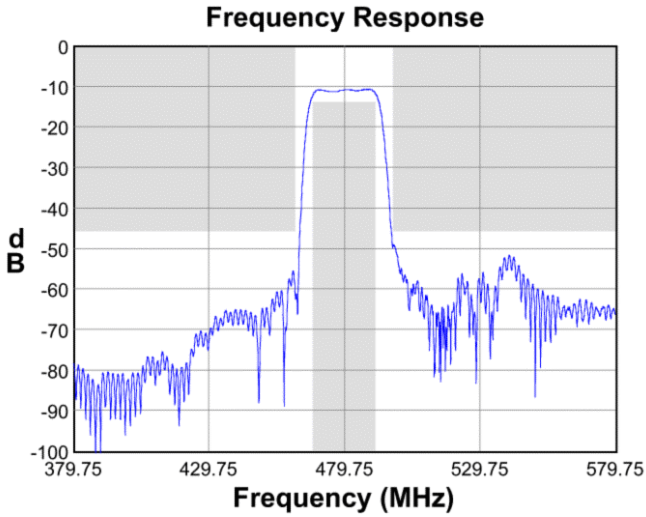

Input Smith Chart

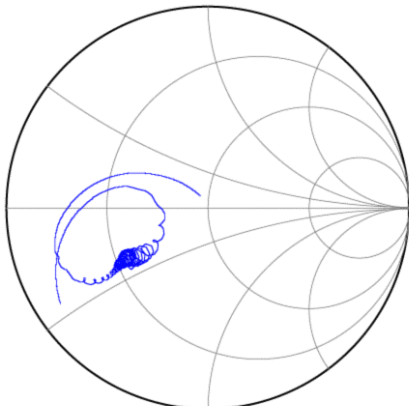

Output Smith Chart

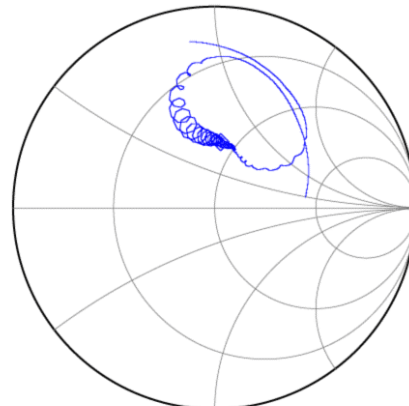

Data Sheet

Matching Schematics

Actual matching values may vary due to PCB layout and parasitics

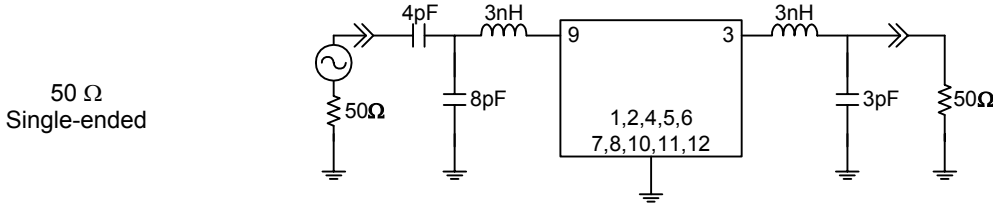

Marking



The date code consists of: day of the current year (Julian, 3 digits), last digit of the year (1 digit) and hour (2 digits)

PCB Footprint

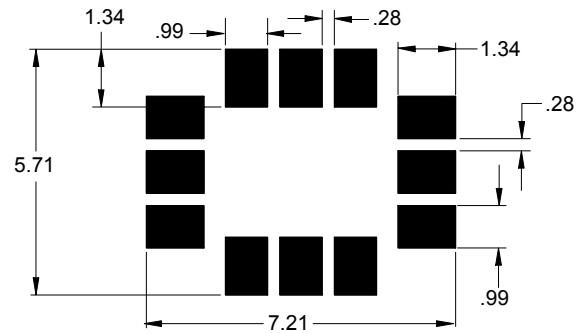

This footprint represents a recommendation only
Dimensions shown are nominal in millimeters

Tape and Reel

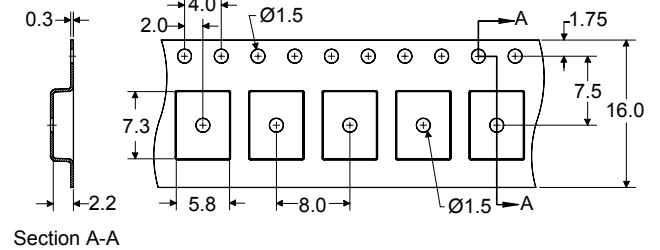
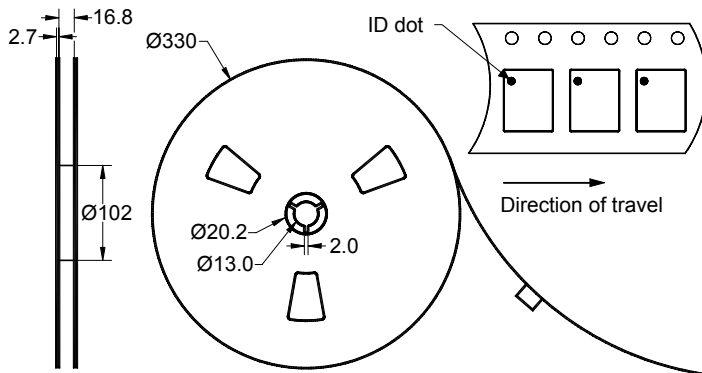

Dimensions shown are nominal in millimeters
Packaging quantity: 3000 units/reel

Data Sheet

Maximum Ratings

Parameter	Symbol	Minimum	Typical	Maximum	Unit
Operating Temperature Range	T	-	+25	-	°C
Storage Temperature Range	T _{stg}	-40	+25	+85	°C

Warnings

- Electrostatic Sensitive Device (ESD) 
- Avoid ultrasonic exposure

Links to Additional Technical Information

[PCB Layout Tips](#)

[Qualification Flowchart](#)

[Soldering Profile](#)

[S-Parameters](#)

[Other Technical Information](#)

Sawtek's liability is limited only to the Surface Acoustic Wave (SAW) component(s) described in this data sheet. Sawtek does not accept any liability for applications, processes, circuits or assemblies which are implemented using any Sawtek component described in this data sheet.

Contact Information



PO Box 609501
 Orlando, FL 32860-9501
 USA

Phone: +1 (407) 886-8860
 Fax: +1 (407) 886-7061
 Email: custservice@sawtek.com
 Web: www.sawtek.com

Or contact one of our worldwide network of [sales offices](#), [representatives](#) or [distributors](#)