

**Features**

- For EGSM applications
- Usable bandwidth 35 MHz
- High attenuation
- No impedance matching required for operation at 50 Ω
- Single-ended operation
- Ceramic Surface Mount Package (SMP)
- Hermetic
- RoHS compliant (2002/95/EC), Pb-free 

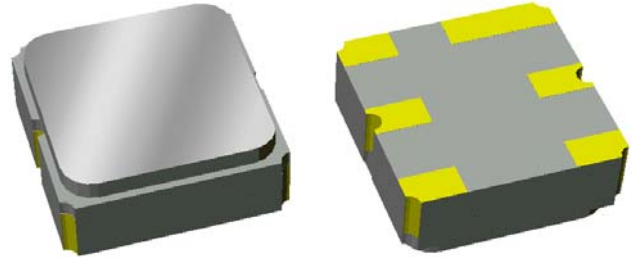

**Package**

Surface Mount 3.00 x 3.00 x 1.22 mm

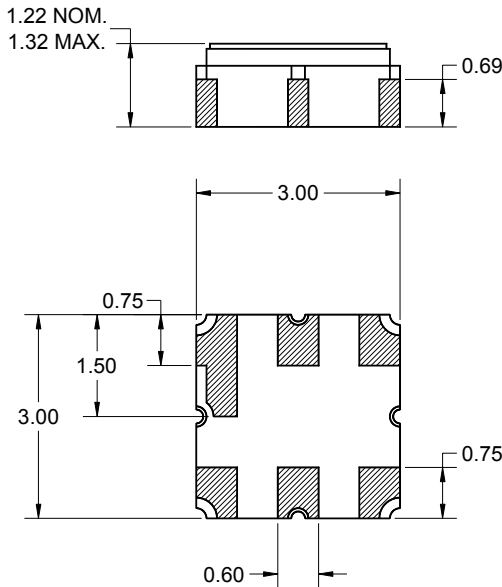

**Pin Configuration**

Bottom View

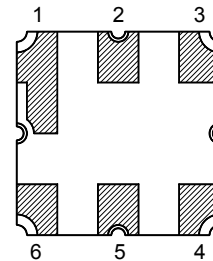

Pin No.	Description
2,5	Input/Output
1,3,4,6	Case ground

Dimensions shown are nominal in millimeters  
All tolerances are ±0.15mm except overall  
length and width ±0.10mm

Body: Al<sub>2</sub>O<sub>3</sub> ceramic  
Lid: Kovar, Ni plated  
Terminations: Au plating 0.5 - 1.0µm,  
over a 2 - 6µm Ni plating

**Electrical Specifications <sup>(1)</sup>**

Operating Temperature Range: <sup>(2)</sup> -40 to +85 °C

Parameter <sup>(3)</sup>	Minimum	Typical	Maximum	Unit
<b>Center Frequency</b>	-	942.5	-	MHz
<b>Maximum Insertion Loss</b>				
925 - 960 MHz (+10 to +35 °C)	-	3.2	3.5	dB
925 - 960 MHz (-40 to +85 °C)	-	-	4.5	dB
<b>Absolute Attenuation</b>				
0 - 880 MHz	40	50	-	dB
880 - 905 MHz	35	38.5	-	dB
905 - 915 MHz	12	26	-	dB
980 - 982 MHz	19	44	-	dB
982 - 1005 MHz	23	44	-	dB
1005 - 1025 MHz	30	42	-	dB
1025 - 1035 MHz	35	42.8	-	dB
1035 - 1760 MHz	40	42.8	-	dB
1760 - 2500 MHz	30	38	-	dB
2500 - 3000 MHz	20	33	-	dB
<b>Input/Output Return Loss</b>				
925 - 960 MHz	6	7.2	-	dB
<b>Source Impedance <sup>(4)</sup></b>	-	50	-	Ω
<b>Load Impedance <sup>(4)</sup></b>	-	50	-	Ω

**Notes:**

1. All specifications are based on the test circuit shown below
2. In production, devices will be tested at room temperature to a guardbanded specification to ensure electrical compliance over temperature
3. Electrical margin has been built into the design to account for the variations due to temperature drift and manufacturing tolerances
4. This is the optimum impedance in order to achieve the performance shown

**Test Circuit:**

50 Ω  
Single-ended

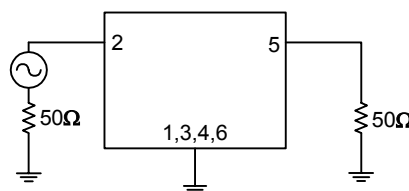

No impedance matching required

**Typical Performance (at +25°C)**

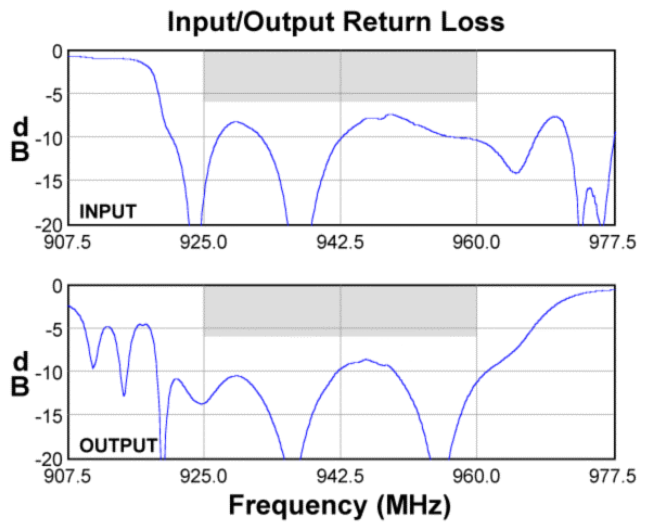
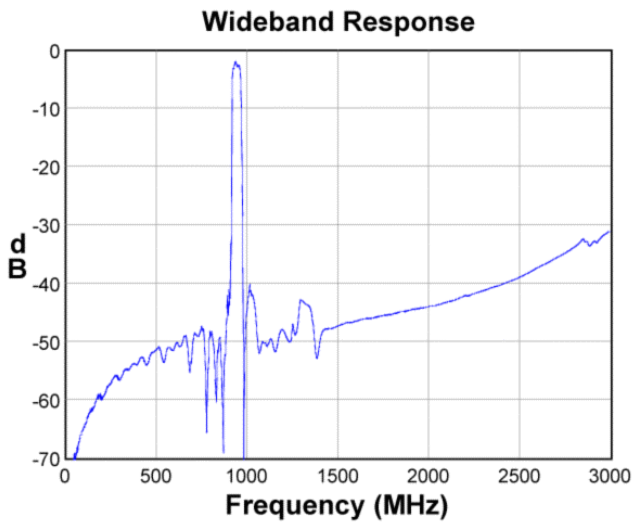
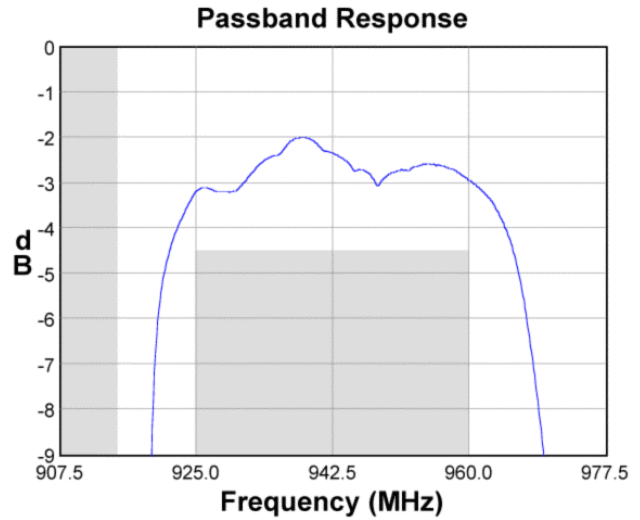
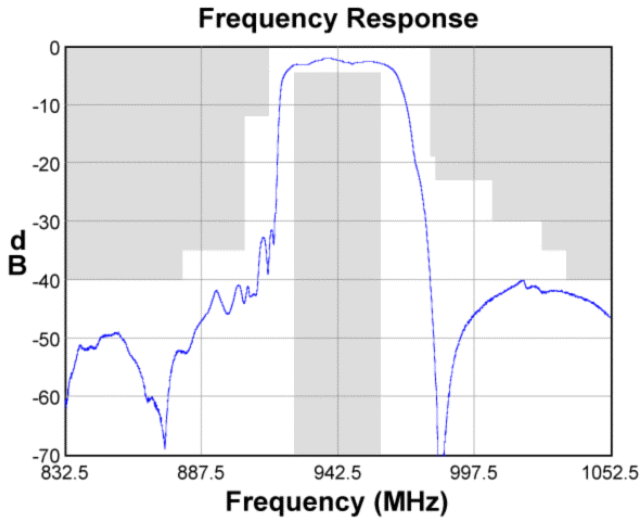

**Input Smith Chart**

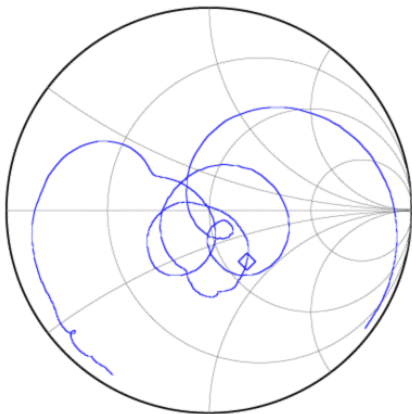

**Output Smith Chart**

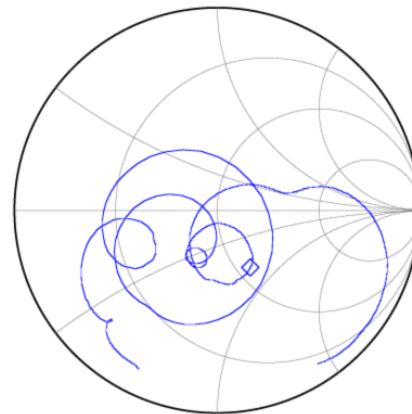

**Matching Schematics**

50 Ω  
Single-ended

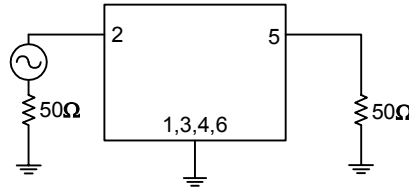

No impedance matching required

**Marking**

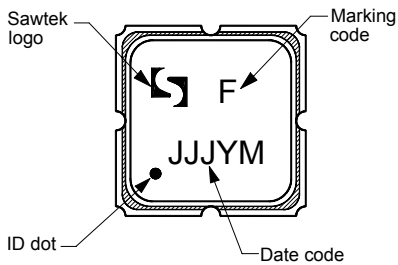

The date code consists of: JJJ = Julian day,  
Y = last digit of year, M = manufacturing site code

**PCB Footprint**

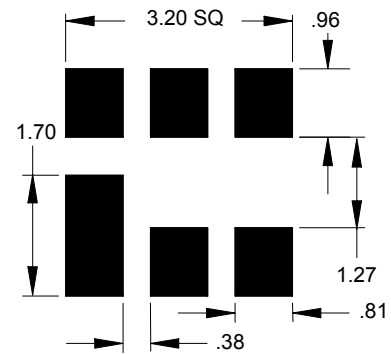

This footprint represents a recommendation only  
Dimensions shown are nominal in millimeters

**Tape and Reel**

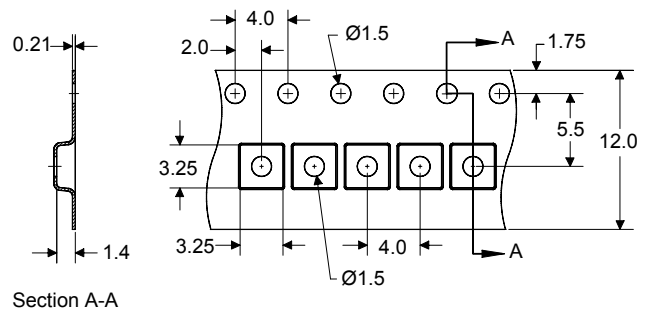
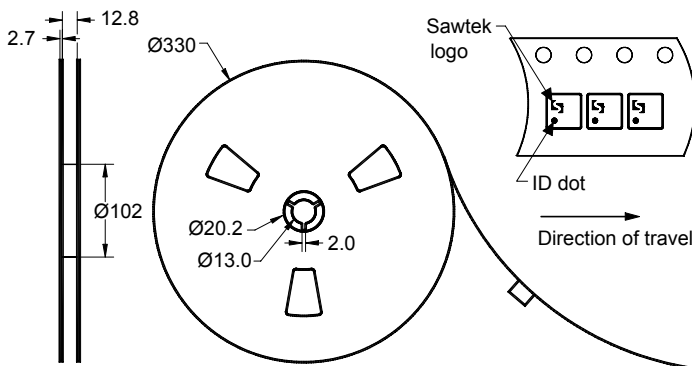

Dimensions shown are nominal in millimeters  
Packaging quantity: 5000 units/reel

**Maximum Ratings**

Parameter	Symbol	Minimum	Maximum	Unit
Operating Temperature Range	T	-40	+85	°C
Storage Temperature Range	T <sub>stg</sub>	-40	+85	°C

**Important Notes**

**Warnings**

- Electrostatic Sensitive Device (ESD) 
- Avoid ultrasonic exposure

**RoHS Compliance**

- This product complies with EU directive 2002/95/EC (RoHS) 

**Solderability**

- Compatible with JEDEC J-STD-020C **Pb-free** process, **260°C** peak reflow temperature ([see soldering profile](#))

**Links to Additional Technical Information**

[PCB Layout Tips](#)

[Qualification Flowchart](#)

[Soldering Profile](#)

[S-Parameters](#)

[RoHS Information](#)

[Other Technical Information](#)

TriQuint's liability is limited only to the Surface Acoustic Wave (SAW) component(s) described in this data sheet. TriQuint does not accept any liability for applications, processes, circuits or assemblies, which are implemented using any TriQuint component described in this data sheet.

**Contact Information**

**TriQuint**   
SEMICONDUCTOR

PO Box 609501  
Orlando, FL 32860-9501  
USA

Phone: +1 (407) 886-8860  
Fax: +1 (407) 886-7061  
Email: [info-product@tqs.com](mailto:info-product@tqs.com)  
Web: [www.triquint.com](http://www.triquint.com)

Or contact one of our worldwide  
Network of [sales offices](#),  
[Representatives or distributors](#)