

# Data Sheet

## Features

- For GPS applications
- Usable bandwidth 2.4 MHz
- Low loss
- No impedance matching required for operation at 50 Ω
- Single-ended operation
- Ceramic Surface Mount Package (SMP)
- Hermetic
- RoHS compliant (2002/95/EC), Pb-free 

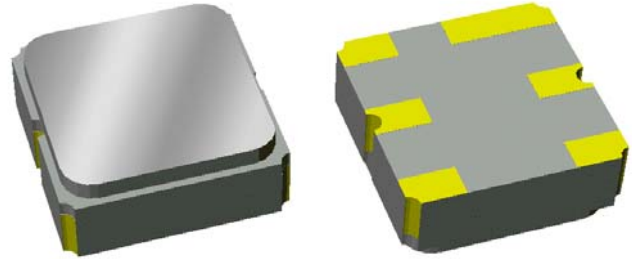

## Package

Surface Mount 3.00 x 3.00 x 1.22 mm

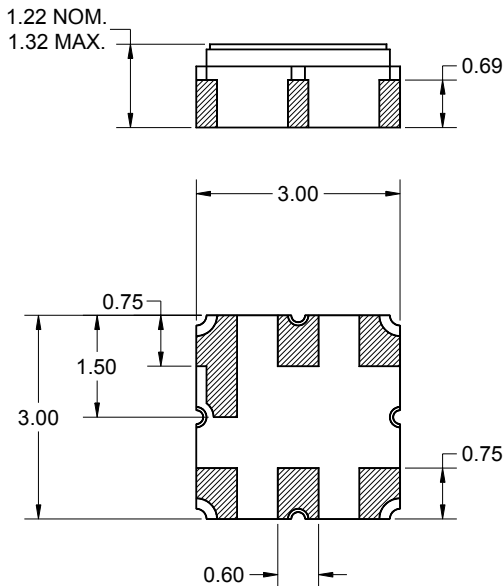

## Pin Configuration

Bottom View

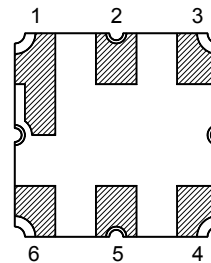

Pin No.	Description
2,5	Input/Output
1,3,4,6	Case ground

Dimensions shown are nominal in millimeters  
 All tolerances are  $\pm 0.15$ mm except overall  
 length and width  $\pm 0.10$ mm

Body:  $Al_2O_3$  ceramic  
 Lid: Kovar, Ni plated  
 Terminations: Au plating 0.5 - 1.0 $\mu$ m,  
 over a 2 - 6 $\mu$ m Ni plating

# Data Sheet

## Electrical Specifications <sup>(1)</sup>

Operating Temperature Range: <sup>(2)</sup> -40 to +85 °C

Parameter <sup>(3)</sup>	Minimum	Typical	Maximum	Unit
<b>Center Frequency</b>	-	1575.42	-	MHz
<b>Maximum Insertion Loss</b> 1574.22 - 1576.62 MHz	-	1.3	1.8	dB
<b>Passband Ripple</b> 1574.22 - 1576.62 MHz	-	0.3	1	dB p-p
<b>Absolute Attenuation</b>				
10 - 1450 MHz	40	42	-	dB
1450 - 1500 MHz	30	45	-	dB
1625 - 1640 MHz	30	58	-	dB
1640 - 2000 MHz	45	49	-	dB
2000 - 3000 MHz	30	35	-	dB
<b>Input/Output VSWR</b> 1574.22 - 1576.62 MHz	-	1.2:1	2:1	dB
<b>Source Impedance:</b> <sup>(4)</sup>	-	50	-	Ω
<b>Load Impedance:</b> <sup>(4)</sup>	-	50	-	Ω

**Notes:**

1. All specifications are based on the test circuit shown below
2. In production, devices will be tested at room temperature to a guardbanded specification to ensure electrical compliance over temperature
3. Electrical margin has been built into the design to account for the variations due to temperature drift and manufacturing tolerances
4. This is the optimum impedance in order to achieve the performance shown

**Test Circuit:**

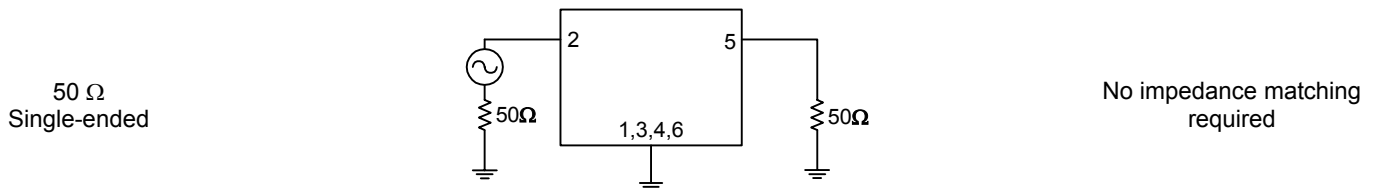

**Data Sheet**

**Typical Performance (at +25°C)**

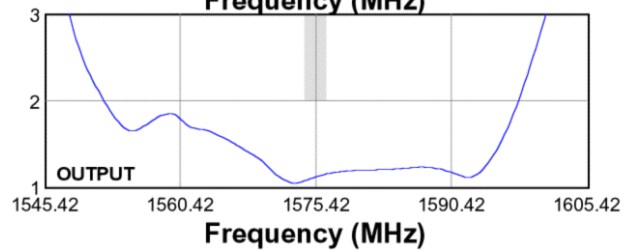
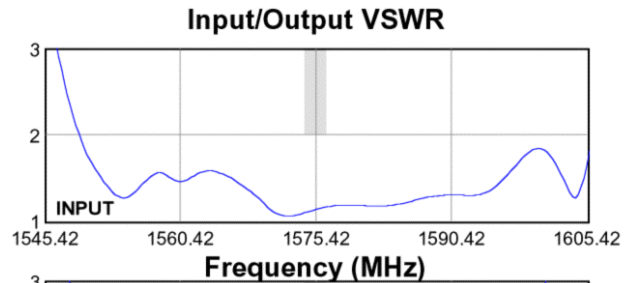
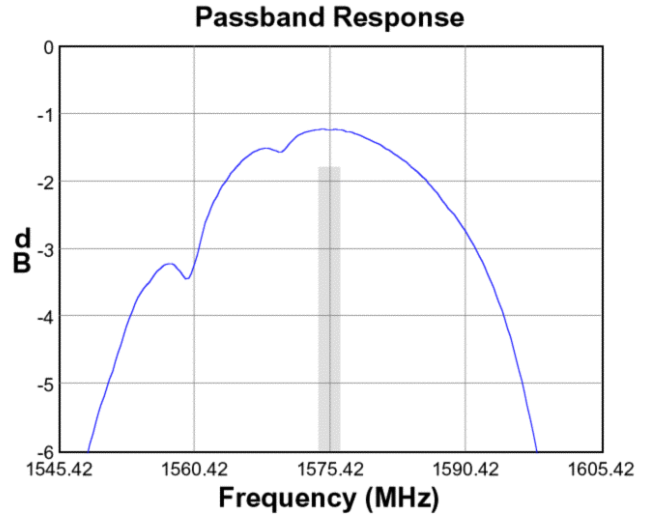
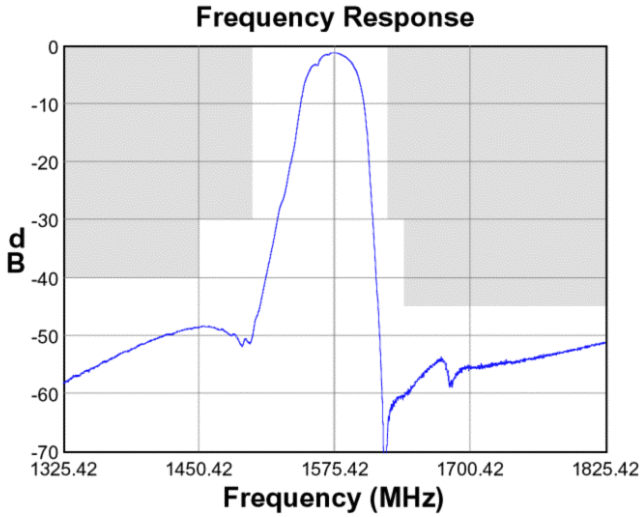

**Input Smith Chart**

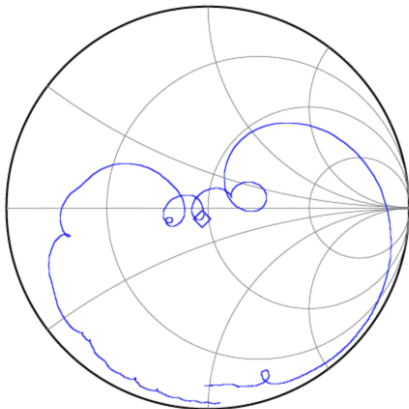

**Output Smith Chart**

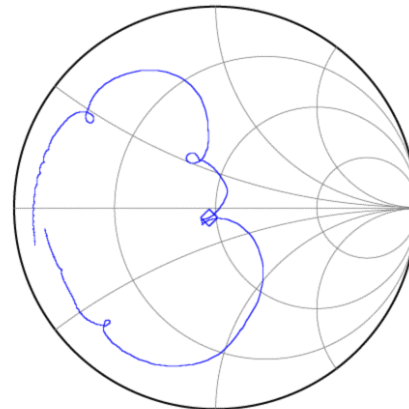

**Data Sheet**

**Matching Schematics**

50 Ω  
Single-ended

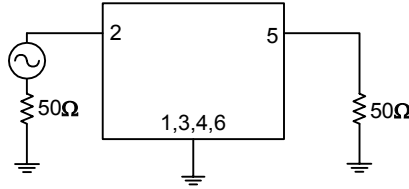

No impedance matching required

**Marking PCB Footprint**

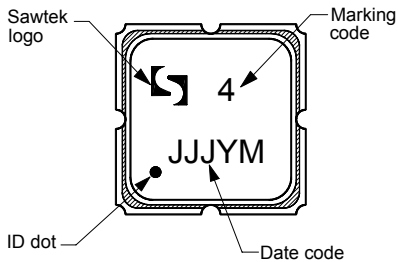

The date code consists of: JJJ = Julian day,  
Y = last digit of year, M = manufacturing site code

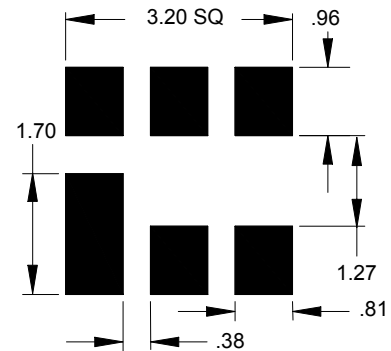

This footprint represents a recommendation only  
Dimensions shown are nominal in millimeters

**Tape and Reel**

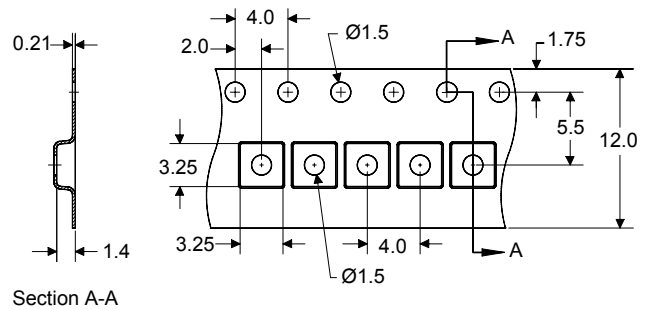
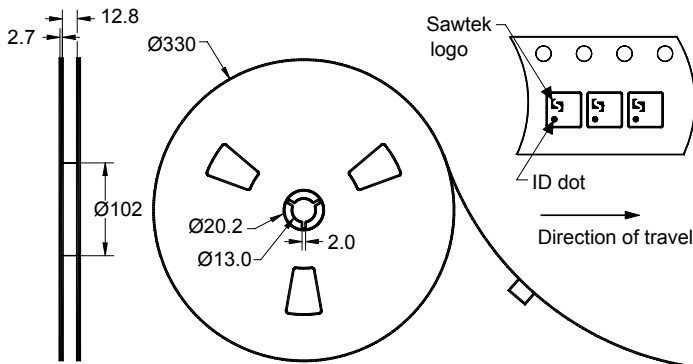

Dimensions shown are nominal in millimeters  
Packaging quantity: 5000 units/reel

# Data Sheet

## Maximum Ratings

Parameter	Symbol	Minimum	Maximum	Unit
Operating Temperature Range	T	-40	+85	°C
Storage Temperature Range	T <sub>stg</sub>	-40	+85	°C
RF Power	P <sub>in</sub>	-	+10	dBm

## Important Notes

### Warnings

- Electrostatic Sensitive Device (ESD) 
- Avoid ultrasonic exposure

### RoHS Compliance

- This product complies with EU directive 2002/95/EC (RoHS) 

### Solderability

- Compatible with JEDEC J-STD-020C **Pb-free** process, **260°C** peak reflow temperature ([see soldering profile](#))

## Links to Additional Technical Information

[PCB Layout Tips](#)

[Qualification Flowchart](#)

[Soldering Profile](#)

[S-Parameters](#)

[RoHS Information](#)

[Other Technical Information](#)

Sawtek's liability is limited only to the Surface Acoustic Wave (SAW) component(s) described in this data sheet. Sawtek does not accept any liability for applications, processes, circuits or assemblies, which are implemented using any Sawtek component described in this data sheet.

## Contact Information



PO Box 609501  
Orlando, FL 32860-9501  
USA

Phone: +1 (407) 886-8860  
Fax: +1 (407) 886-7061  
Email: [custservice@sawtek.com](mailto:custservice@sawtek.com)  
Web: [www.sawtek.com](http://www.sawtek.com)

Or contact one of our worldwide  
Network of [sales offices](#),  
[representatives or distributors](#)