

# 856654

## 1747.5 MHz SAW Filter

### Applications

- General purpose wireless
- Wireless infrastructure
- 3G, 4G, Multistandard
- Repeaters

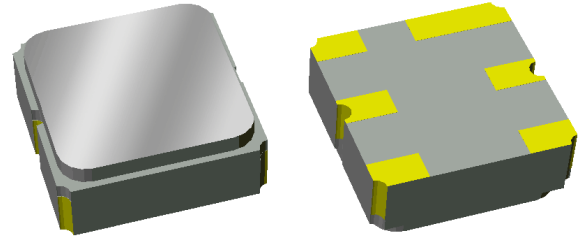

### Product Features

- Usable bandwidth 75 MHz
- Single-ended operation
- Ceramic Surface Mount Package (SMP)
- Matching required for operation at 50Ω
- Small Size: 3.00 x 3.00 x 1.22 mm
- Hermetically sealed
- **RoHS** compliant, **Pb**-free

### General Description

856654 is a general purpose Uplink filter for band 3. This filter was specifically designed in a 3x3mm hermetic package for base station applications and is part of our wide portfolio of RF filters in the same package.

Low insertion loss, coupled with high attenuation, makes this filter a natural choice for our customers Uplink RF filtering needs.

### Functional Block Diagram

Top view

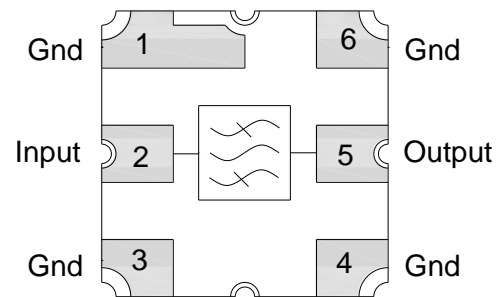

### Pin Configuration

Pin #	SE	Description
2		Input
5		Output
1,3,4,6		Case Ground

### Ordering Information

Part No.	Description
856654	packaged part
856654-EVB	evaluation board

Standard T/R size = 5000 units/reel.

## Specifications

### Electrical Specifications <sup>(1)</sup>

Specified Temperature Range: <sup>(2)</sup> -30 to +85 °C

Parameter <sup>(3)</sup>	Conditions	Min	Typical <sup>(4)</sup>	Max	Units
Center Frequency		-	1747.5	-	MHz
Maximum Insertion Loss	1710 – 1785 MHz	-	2.2	2.8	dB
Amplitude Ripple	1710 – 1785 MHz	-	-	1.6	dB p-p
Absolute Attenuation <sup>(5)</sup>	180 – 220 MHz	38	46	-	dB
	1197 – 1452 MHz	50	54	-	dB
	1606 – 1676 MHz	5.5	7	-	dB
	2100 – 2157 MHz	20	26	-	dB
	2680 – 3005 MHz	15	22	-	dB
	3197 – 6000 MHz	6	9	-	dB
Input/output Return Loss	1710 – 1785 MHz	10	13	-	dB
Source Impedance (single-ended) <sup>(6)</sup>		-	50	-	Ω
Load Impedance (single-ended) <sup>(6)</sup>		-	50	-	Ω

Notes:

- All specifications are based on the TriQuint schematic for the main reference design shown on page 3
- In production, devices will be tested at room temperature to a guardbanded specification to ensure electrical compliance over temperature
- Electrical margin has been built into the design to account for the variations due to temperature drift and manufacturing tolerances
- Typical values are based on average measurements at room temperature
- Relative to minimum insertion Loss
- This is the optimum impedance in order to achieve the performance shown

### Absolute Maximum Ratings

Parameter	Rating
Operating Temperature	-30 to +85 °C
Storage Temperature	-40 to +85 °C
Input Power <sup>(7)</sup>	+5 dBm

- Device is measured for equivalent 10K hours @ +55 °C [CW Signal]

Operation of this device outside the parameter ranges given above may cause permanent damage.

# 856654

## 1747.5 MHz SAW Filter

### Reference Design 1 – 50Ω SE Input, 50Ω SE Output

#### Schematic

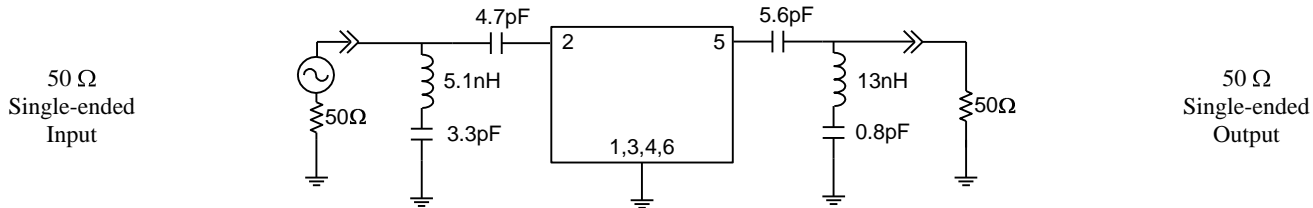

Notes:

1. No impedance matching required
2. Actual matching values may vary due to PCB layout and parasitic

#### PC Board

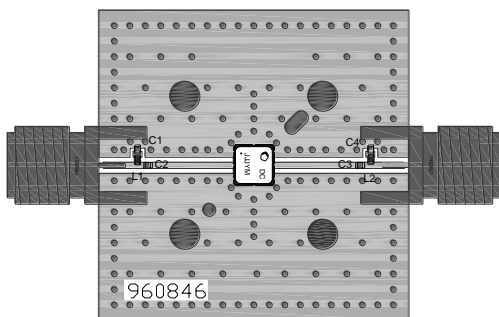

Notes:

- Top, middle & bottom layers: 1/2 oz copper
- Substrates: FR4 dielectric .063” / Taconic TLY-5A .0075”
- Finish plating: Nickel: 3-8μm thick, Gold: .03-.2μm thick
- Hole plating: Copper min .0008μm

#### Mounting Configuration

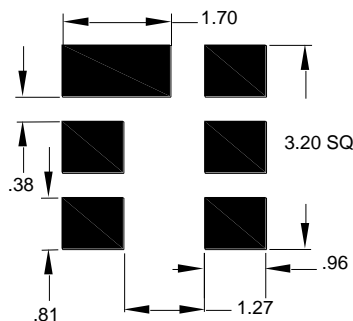

Notes:

1. All dimensions are in millimeters.
2. This footprint represents a recommendation only.

#### Bill of Material

Reference Desg.	Value	Description	Manufacturer	Part Number
L1	5.1 nH	Coil Wire-wound, 0402, 5%	MuRata	LQW15AN5N1B00
L2	13 nH	Coil Wire-wound, 0402, 5%	MuRata	LQW15AN13NG00
C1	4.7 pF	Chip Ceramic, 0402, 5%	MuRata	GRM15551H2R4GZ01
C2	3.3 pF	Chip Ceramic, 0402, 5%	MuRata	GRM15551H3R3GZ01
C3	5.6 pF	Chip Ceramic, 0402, 5%	MuRata	GRM15551H5R6GZ01
C4	0.8 pF	Chip Ceramic, 0402, 5%	MuRata	GRM15551HR80KZ01
SMA	N/A	SMA connector	Radiall USA Inc.	9602-1111-018
PCB	N/A	3-layer	multiple	960700

**Typical Performance (at room temperature)**

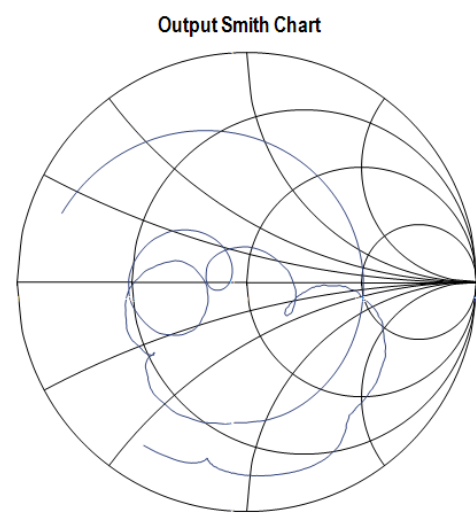
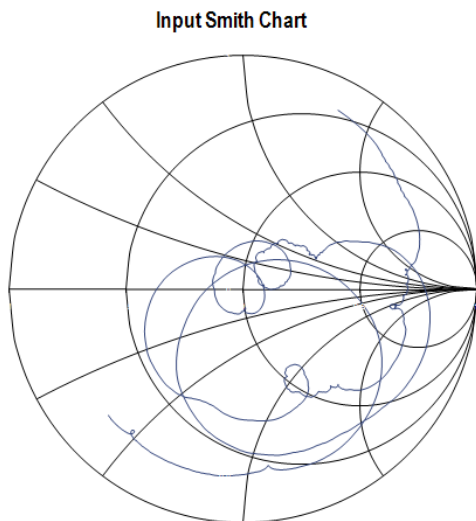
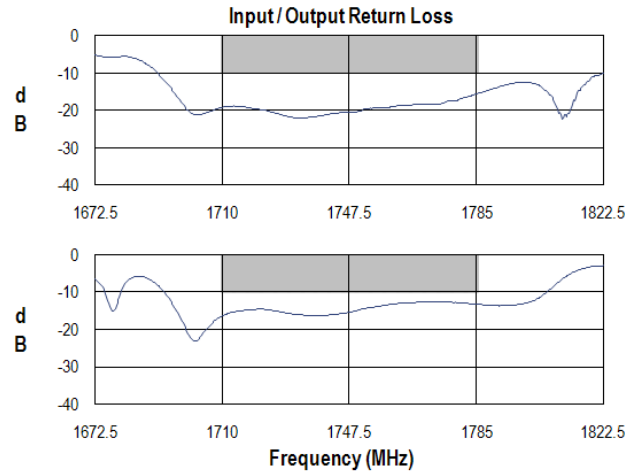
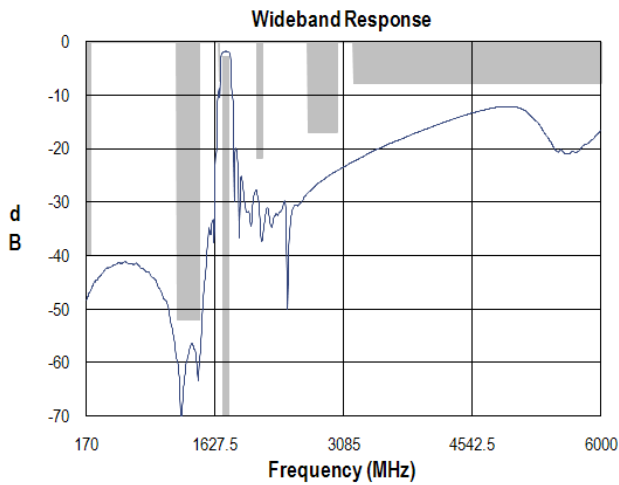
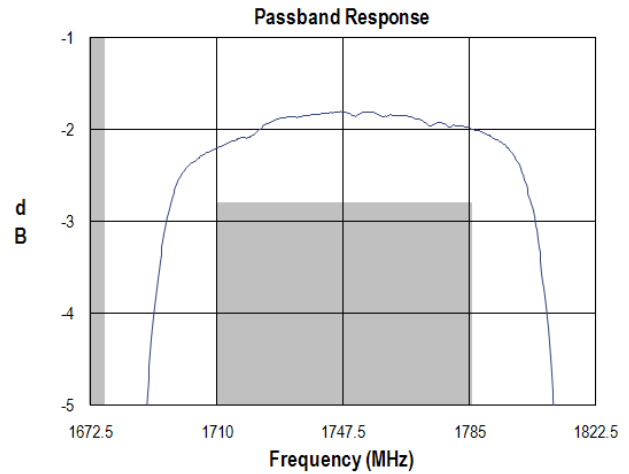
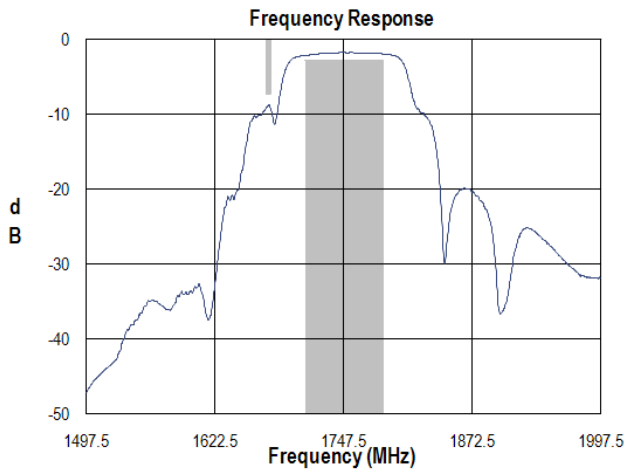

# 856654

## 1747.5 MHz SAW Filter

### Mechanical Information

#### Package Information, Dimensions and Marking

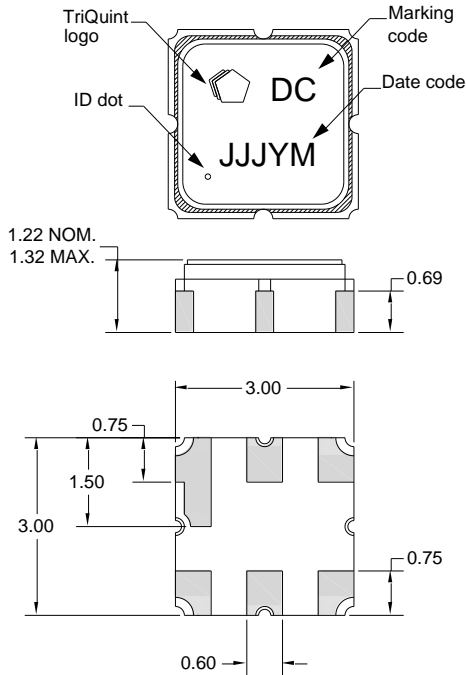

Package Style: SMP-12A  
Dimensions: 3.00 x 3.00 x 1.22 mm

Body:  $Al_2O_3$  ceramic  
Lid: Kovar, Ni plated  
Terminations: Au plating 0.5 - 1.0 $\mu$ m, over a 2-6 $\mu$ m Ni plating

All dimensions shown are nominal in millimeters  
All tolerances are  $\pm 0.15$ mm except overall length and width  $\pm 0.10$ mm

The date code consists of day of the current year (Julian, 3 digits), Y = last digit of the year, and M = manufacturing site code

### Tape and Reel Information

Standard T/R size = 5000 units/reel. All dimensions are in millimeters

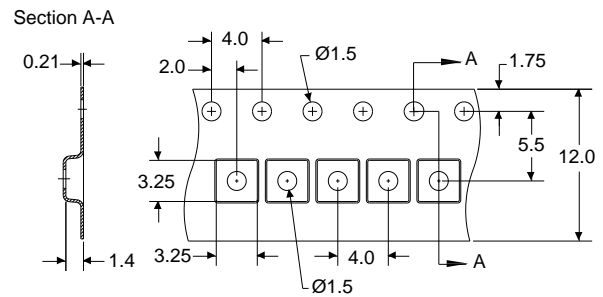
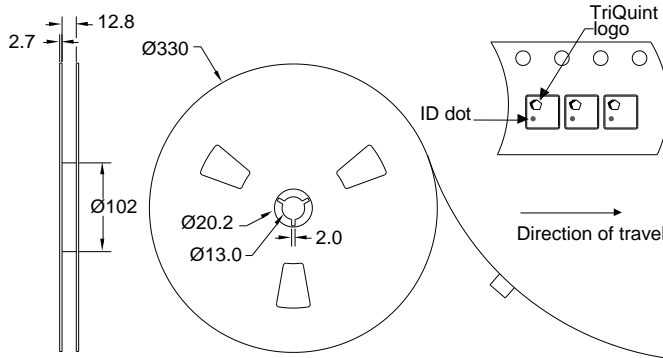

## Product Compliance Information

### ESD Information



#### Caution! ESD-Sensitive Device

ESD Rating: 1A

Value: Passes  $\geq 300$  V min.  
Test: Human Body Model (HBM)  
Standard: JEDEC Standard JESD22-A114

ESD Rating: A

Value: Passes  $\geq 150$  V min.  
Test: Machine Model (MM)  
Standard: JEDEC Standard JESD22-A115

### MSL Rating

Devices are Hermetic, therefore MSL is not applicable

### Solderability

Compatible with the latest version of J-STD-020, lead free solder, 260°C

Refer to [Soldering Profile](#) for recommended guidelines.

This part is compliant with EU 2002/95/EC RoHS directive (Restrictions on the Use of Certain Hazardous Substances in Electrical and Electronic Equipment).

This product also has the following attributes:

- Halogen Free (Chlorine, Bromine)
- Antimony Free
- TBBP-A (C<sub>15</sub>H<sub>12</sub>Br<sub>4</sub>O<sub>2</sub>) Free
- PFOS Free
- SVHC Free

## Contact Information

For the latest specifications, additional product information, worldwide sales and distribution locations, and information about TriQuint:

Web: [www.triquint.com](http://www.triquint.com)  
Email: [info-sales@tqs.com](mailto:info-sales@tqs.com)

Tel: +1.407.886.8860  
Fax: +1.407.886.7061

For technical questions and application information:

Email: [flapplication.engineering@tqs.com](mailto:flapplication.engineering@tqs.com)

## Important Notice

The information contained herein is believed to be reliable. TriQuint makes no warranties regarding the information contained herein. TriQuint assumes no responsibility or liability whatsoever for any of the information contained herein. TriQuint assumes no responsibility or liability whatsoever for the use of the information contained herein. The information contained herein is provided "AS IS, WHERE IS" and with all faults, and the entire risk associated with such information is entirely with the user. All information contained herein is subject to change without notice. Customers should obtain and verify the latest relevant information before placing orders for TriQuint products. The information contained herein or any use of such information does not grant, explicitly or implicitly, to any party any patent rights, licenses, or any other intellectual property rights, whether with regard to such information itself or anything described by such information.

TriQuint products are not warranted or authorized for use as critical components in medical, life-saving, or life-sustaining applications, or other applications where a failure would reasonably be expected to cause severe personal injury or death.