

Features

- For UMTS applications
- Usable bandwidth of 60 MHz
- Low loss
- No impedance matching required for operation at 50 Ω
- Single-ended operation
- Ceramic Surface Mount Package (SMP)
- Hermetic
- **RoHS** compliant (2002/95/EC), **Pb-free** 

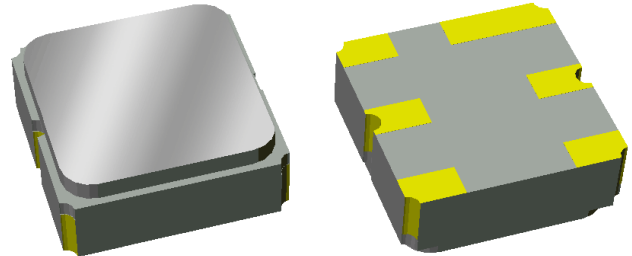

Package

Surface Mount 3.00 x 3.00 x 1.22 mm
SMP-12

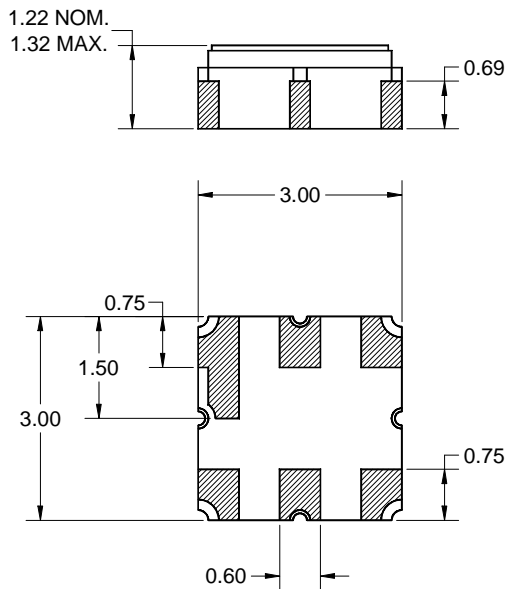

Pin Configuration

Bottom View

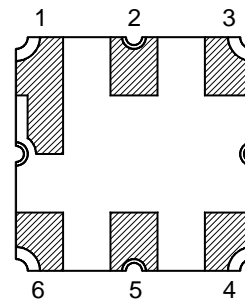

Single-ended Configuration

Pin No.	Description
2	Input
5	Output
1,3,4,6	Case ground

Dimensions shown are nominal in millimeters
All tolerances are ± 0.15 mm except overall
length and width ± 0.10 mm

Body: Al_2O_3 ceramic
Lid: Kovar, Ni plated
Terminations: Au plating 0.5 - 1.0 μ m,
over a 2 - 6 μ m Ni plating

Electrical Specifications ⁽¹⁾

Operating Temperature Range: ⁽²⁾ -30 to +85 °C

Parameter ⁽³⁾	Minimum	Typical ⁽⁴⁾	Maximum	Unit
Center Frequency	-	2140	-	MHz
Maximum Insertion Loss 2110 – 2170 MHz	-	2.3	3.5	dB
Amplitude Variation 2110 – 2170 MHz	-	0.9	1.5	dB p-p
Absolute Attenuation ⁽⁵⁾				
10 – 1980 MHz	25	27	-	dB
1980 – 2025 MHz	30	33	-	dB
2025 – 2050 MHz	25	31	-	dB
2225 – 2260 MHz	30	36	-	dB
2260 – 3000 MHz	25	30	-	dB
Input/Output Return Loss 2110 – 2170 MHz	9	12	-	dB
Source Impedance (single-ended) ⁽⁶⁾	-	50	-	Ω
Load Impedance (single-ended) ⁽⁶⁾	-	50	-	Ω

Notes:

1. All specifications are based on the TriQuint test circuit shown below
2. In production, devices will be tested at room temperature to a guardbanded specification to ensure electrical compliance over temperature
3. Electrical margin has been built into the design to account for the variations due to temperature drift and manufacturing tolerances
4. Typical values are based on average measurements at room temperature
5. Relative to zero dB
6. This is the optimum impedance in order to achieve the performance shown

Test Circuit:

Actual matching values may vary due to PCB layout and parasitics

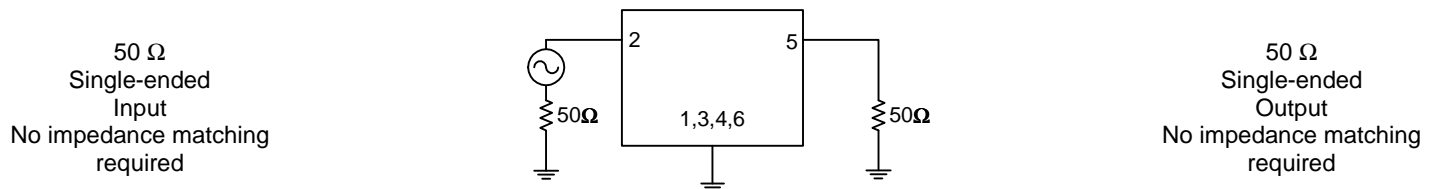

Typical Performance (at room temperature)

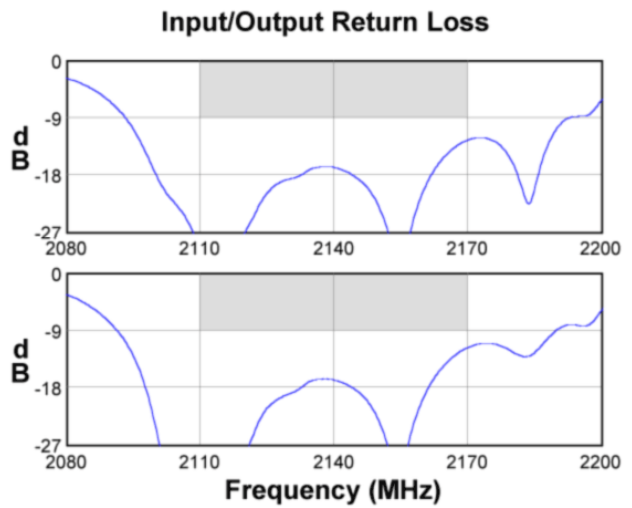
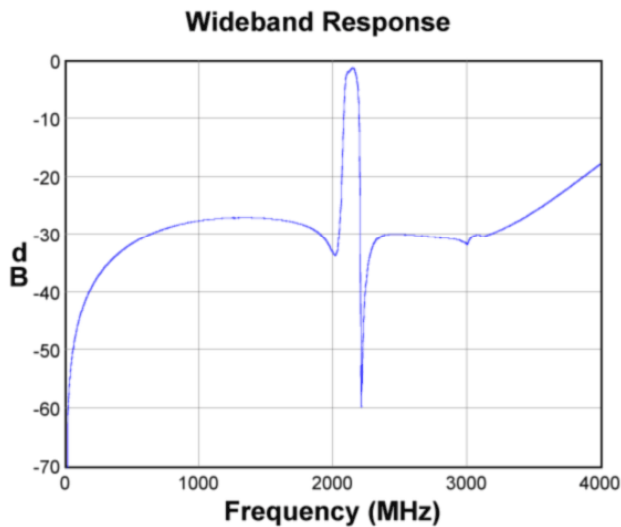
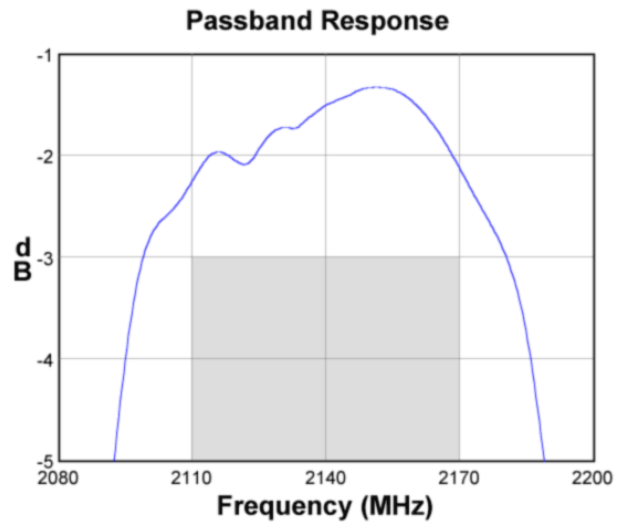
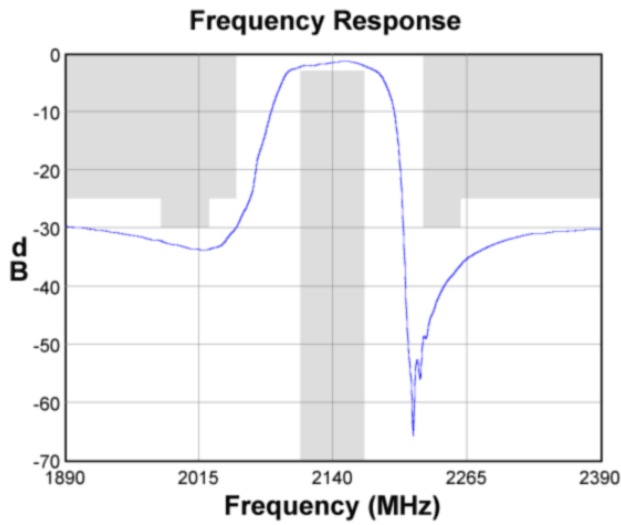

Input Smith Chart

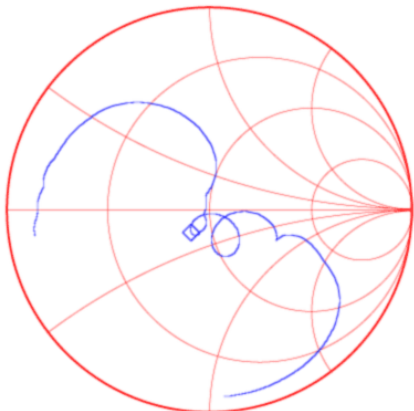

Output Smith Chart

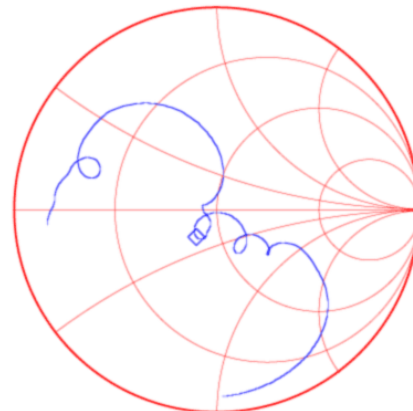

Matching Schematics

Actual matching values may vary due to PCB layout and parasitics

50 Ω
Single-ended
Input
No impedance matching
required

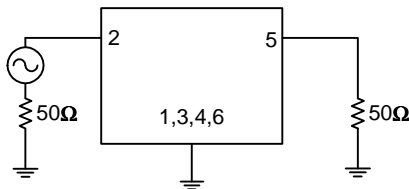

50 Ω
Single-ended
Output
No impedance matching
required

Marking

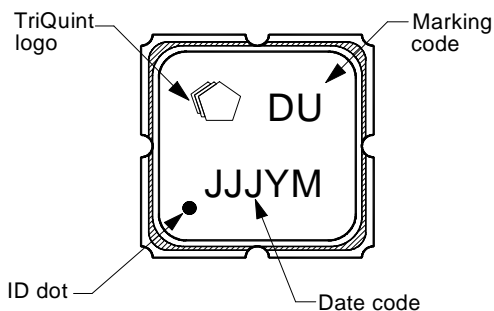

The date code consists of: day of the current year (Julian, 3 digits), last digit of the year (1 digit) and hour (2 digits)

PCB Footprint

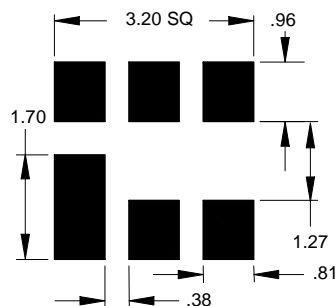

This footprint represents a recommendation only
Dimensions shown are nominal in millimeters

Tape and Reel

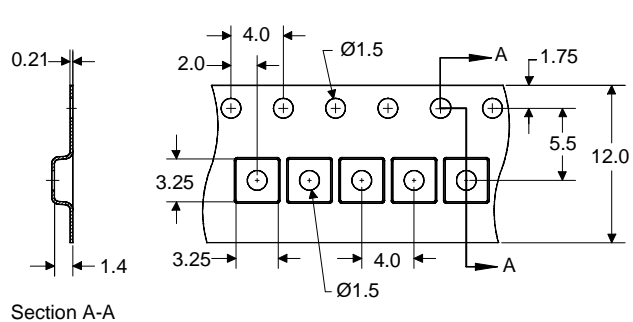
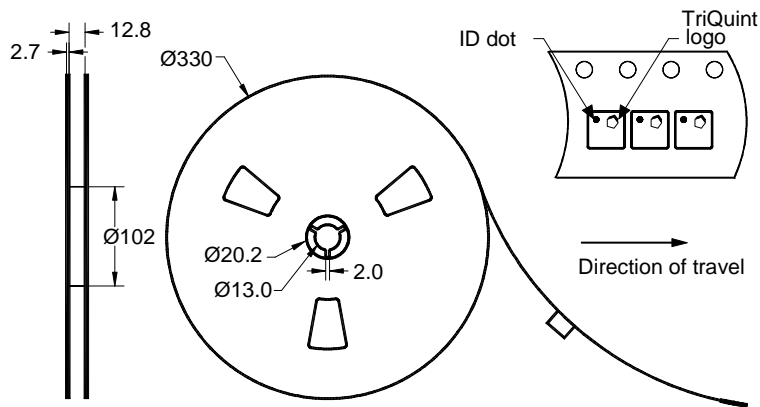

Dimensions shown are nominal in millimeters
Packaging quantity: 5000 units/reel

Maximum Ratings

Parameter	Symbol	Minimum	Maximum	Unit
Operating Temperature Range	T	-30	+85	°C
Storage Temperature Range	T _{stg}	-40	+85	°C
Input Power	P _{in}	-	+10	dBm

Important Notes

Warnings

- Electrostatic Sensitive Device (ESD) 
- Avoid ultrasonic exposure

RoHS Compliance

- This product complies with EU directive 2002/95/EC (RoHS) 

Solderability

- Compatible with JESD22-B102, Pb-free process, 260C peak reflow temperature ([see soldering profile](#))

Links to Additional Technical Information

[PCB Layout Tips](#)

[Qualification Flowchart](#)

[Soldering Profile](#)

[S-Parameters](#)

[RoHS Information](#)

[Other Technical Information](#)

TriQuint's liability is limited only to the Surface Acoustic Wave (SAW) component(s) described in this data sheet. TriQuint does not accept any liability for applications, processes, circuits or assemblies, which are implemented using any TriQuint component described in this data sheet.

Contact Information

TriQuint 
SEMICONDUCTOR

PO Box 609501
Orlando, FL 32860-9501
USA

Phone: +1 (407) 886-8860
Fax: +1 (407) 886-7061
Email: info-product@tqs.com
Web: www.triquint.com

Or contact one of our worldwide
Network of [sales offices](#),
[Representatives or distributors](#)