

Wideband Low Noise Amplifier

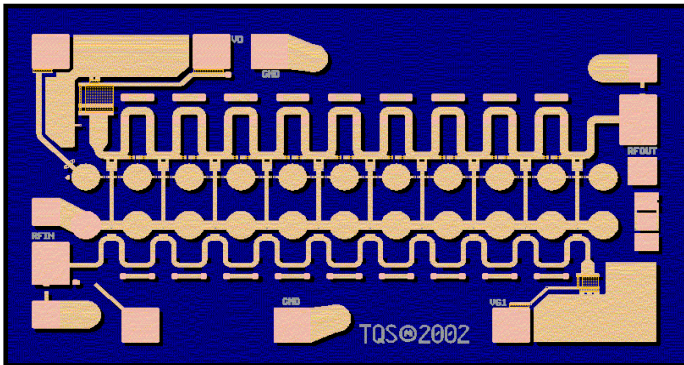

Key Features and Performance

- DC - 45GHz Frequency Range
- 13dB Gain @ 20GHz
- 15dB Return Loss @ 20GHz
- 11.5dBm Typical P1dB
- 3.2dB Typical Noise Figure
- 40Gbps Data Rate
- > 20dB Gain Control
- 0.15 μ m pHEMT 3MI Technology
- 5V, 50mA Bias Condition
- Chip Dimensions:
1.79 x 1.00 x 0.10 mm
(0.070 x 0.039 x 0.004 inches)

Measured Performance

$V^+ = 5V, I^+ = 50mA$

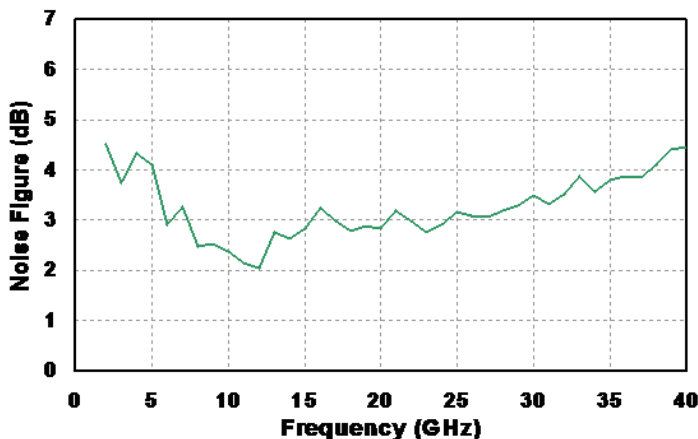
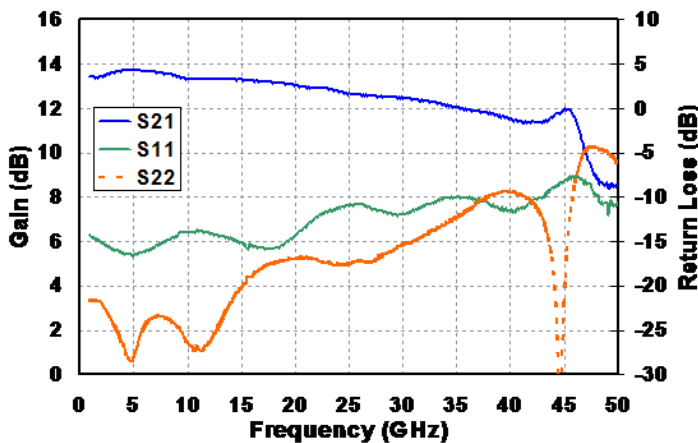

Primary Applications

- Test Equipment
- Ultra Wideband
- EW Systems
- Fiberoptic Systems

Product Description

The TriQuint TGA4830 is a medium power wideband low noise amplifier which operates from DC to 45 GHz. Typical small signal gain is 13dB with >20dB AGC range. Typical input and output return loss is 15dB. The TGA4830 provides 11.5 dBm of typical output power at 1 dB gain compression and a 3.2dB noise figure. RF ports are DC coupled enabling the user to customize system corner frequencies.

The TGA4830 is suitable for a variety of wideband electronic warfare systems such as radar warning receivers, electronic counter measures, decoys, jammers and phased array systems. It is also an excellent choice for 40Gb/s NRZ applications. The TGA4830 is capable of driving an Electro-Absorptive optical Modulator (EAM) with electrical Non-Return to Zero (NRZ) data. In addition, the TGA4830 may also be used as a predriver or a receive gain block.

**TABLE I
MAXIMUM RATINGS**

Symbol	Parameter 1/	Value	Notes
V ⁺ V _D	POSITIVE SUPPLY VOLTAGE Biased Thru On-Chip Termination	10 V	2/, 3/
	Biased Thru RF Out	7 V	
I ⁺ I _D	POSITIVE SUPPLY CURRENT Biased Thru On-Chip Termination	72 mA	3/
	Biased Thru RF Out	180m A	
P _D ⁺ P _D	POWER DISSIPATION Biased Thru On-Chip Termination	0.7 W	3/ 4/
	Biased Thru RF Out	1.26 W	
V _G	Gate Voltage Range	-3V TO +1V	
I _G	Gate Current	10 mA	
V _{CTRL}	Control Voltage Range	+5V TO (V _D - V _{CTRL} ≤ 8V)	5/
I _{CTRL}	Control Current	10 mA	
P _{IN}	Input Continuous Wave Power	19.2 dBm	
V _{IN}	40Gbps PRBS Voltage Input	TBD	
T _{CH}	Channel Temperature	200 °C	6/
	Mounting Temperature (30 Seconds)	320 °C	
T _{STG}	Storage Temperature	-65 to 150 °C	

- 1/ These ratings represent the maximum operable values for this device.
- 2/ Assure $V_D - V_{CTRL} \leq 8V$. Compute V_D as follows: $V_D = V^+ - I^+ * 40$
- 3/ Combinations of supply voltage, supply current, input power, and output power shall not exceed P_D.
- 4/ When operated at this bias condition with a base plate temperature of 70 °C, the median life is 2.6E5 hours.
- 5/ Assure V_{CTRL} never exceeds V_D during bias up and bias down sequences. Also, V_{CTRL} must never exceed 5V during normal operation.
- 6/ Junction operating temperature will directly affect the device mean time to failure (T_m). For maximum life it is recommended that junction temperatures be maintained at the lowest possible levels

TABLE II
RF CHARACTERIZATION TABLE
 (T_A = 25°C, Nominal)
 (V⁺ = 5V, I⁺ = 50mA)

Symbol	Parameter	Test Conditions	Typ	Units	Notes
Gain	Small Signal Gain	F = 1 – 30 GHz	13	dB	
BW	Small Signal 3dB Bandwidth		45	GHz	
IRL	Input Return Loss	F = 1 – 30 GHz	12	dB	
ORL	Output Return Loss	F = 1 – 30 GHz	15	dB	
P1dB	Output Power @ 1dB Gain Compression	F = 1 – 25 GHz	11.5	dBm	
NF	Noise Figure	F = 1 – 40 GHz	3.2	dB	

Note: Table II Lists the RF Characteristics of typical devices as determined by fixtured measurements.

**TABLE III
THERMAL INFORMATION**

Parameter	Test Conditions	T _{CH} (°C)	θ _{JC} (°C/W)	T _m (hrs)
θ _{JC} Thermal Resistance (Channel to Backside of Carrier)	V ⁺ = 5V I ⁺ = 50mA P _{DISS} = 0.25W T _{BASE} = 70 °C	82.3	49.2	4.2E+7

Note: Assumes eutectic attach using 1.5mil 80/20 AuSn mounted to a 20mil CuMo carrier at 70 °C baseplate temperature. Worst case conditions with no RF applied, 100% of DC power is dissipated.

Median Lifetime (T_m) vs. Channel Temperature

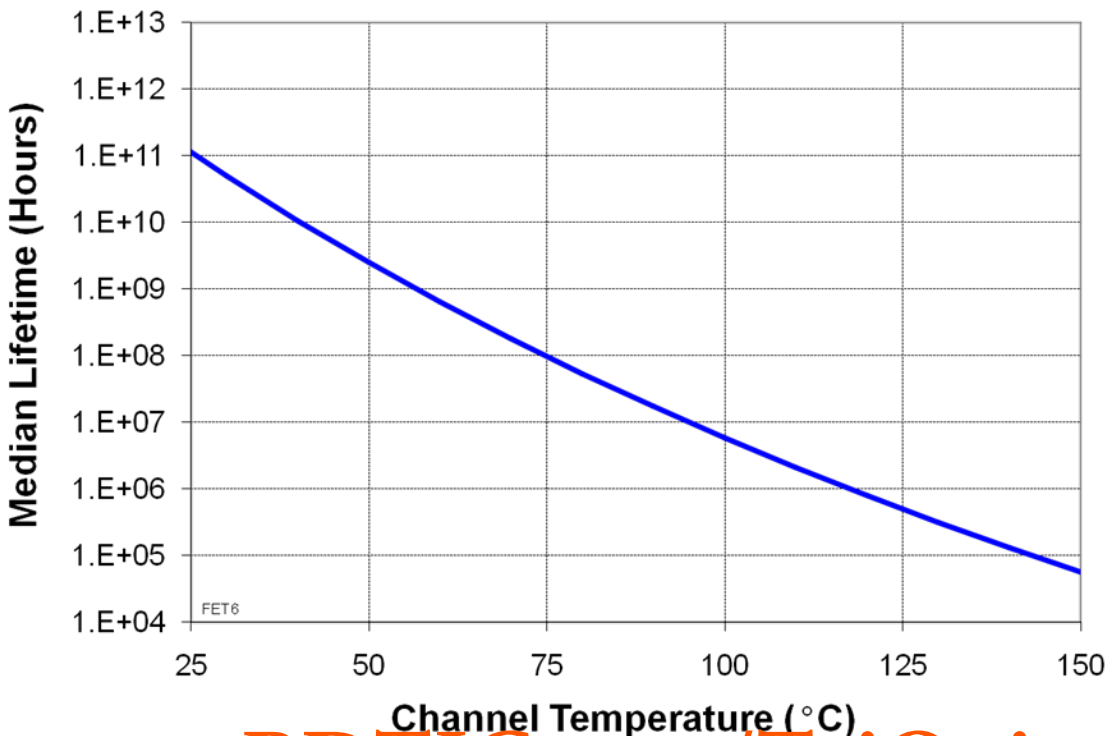

Preliminary Data

$V^+ = 5V, I^+ = 50mA$

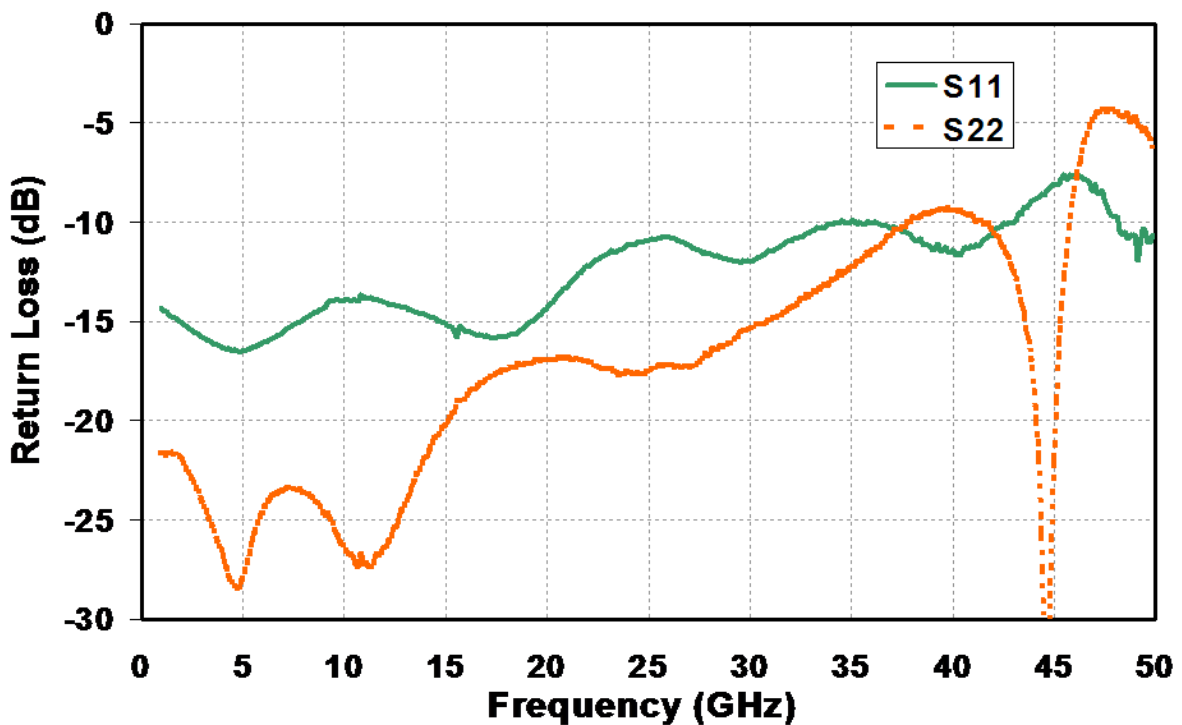
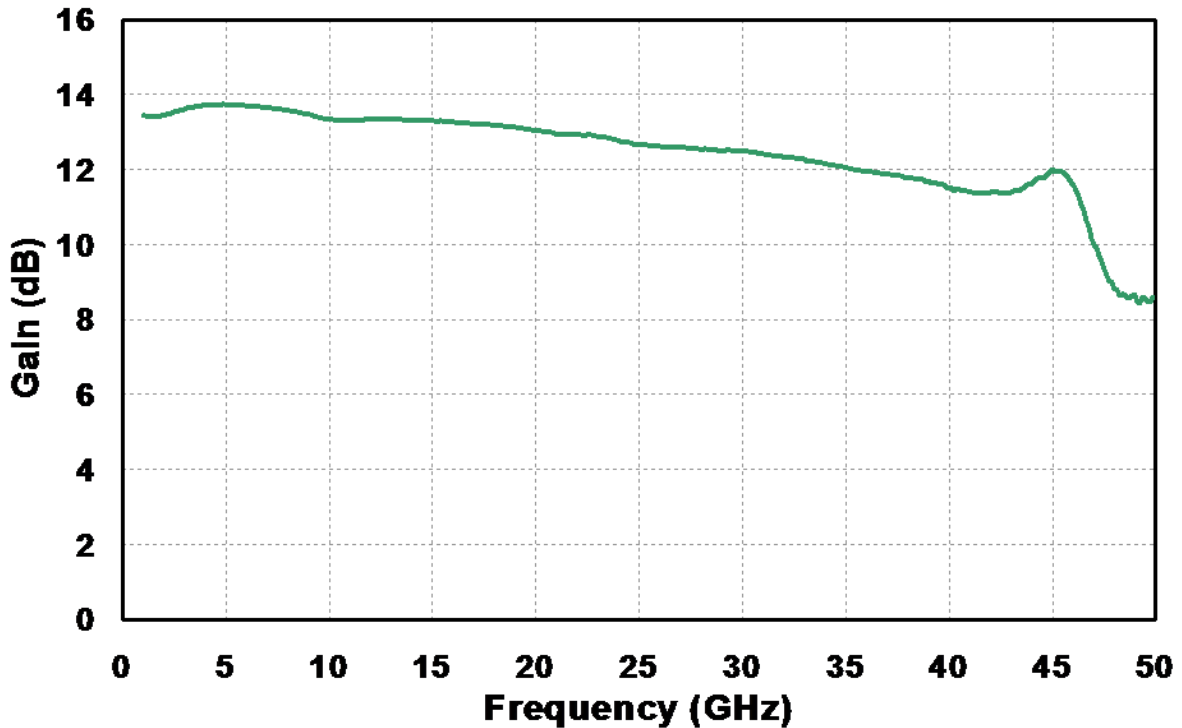

Preliminary Data
 $V^+ = 5V, I^+ = 50mA$

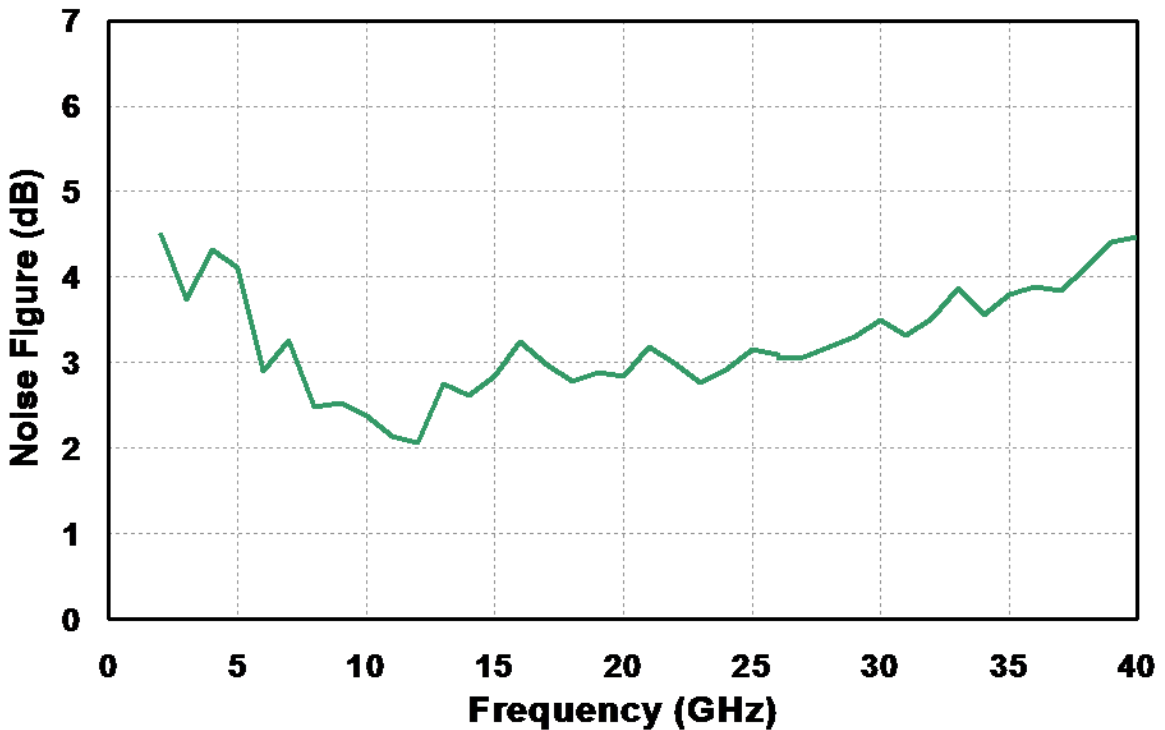
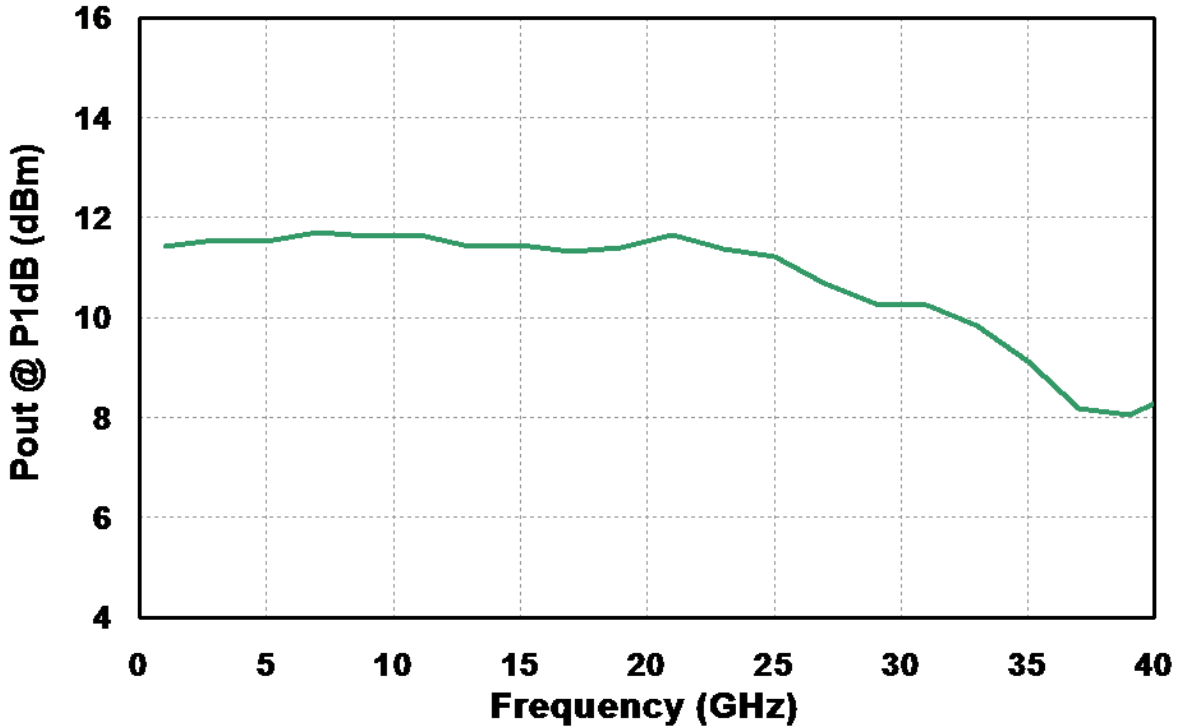

Preliminary Data

$V^+ = 5V$, $I^+ = 60mA$, $V_{IN} = 0.62V_{PP}$, $V_{OUT} = 2.25V_{PP}$

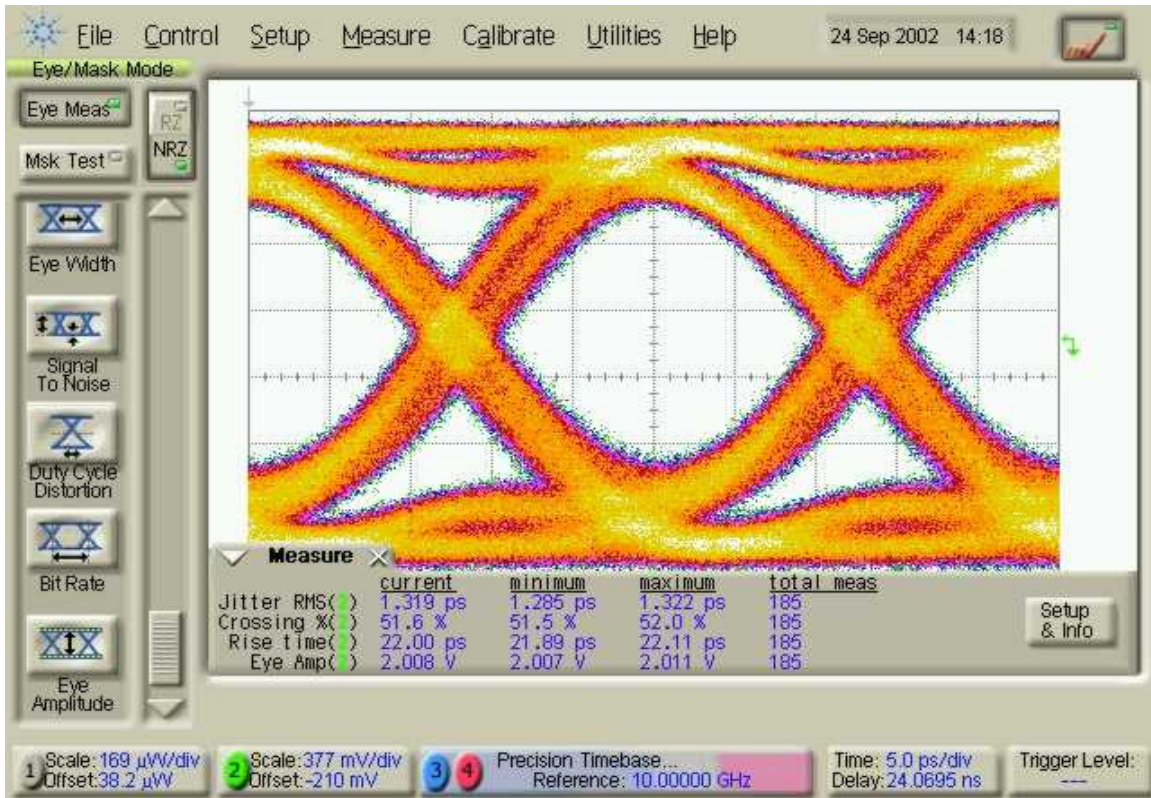

Mechanical Drawing

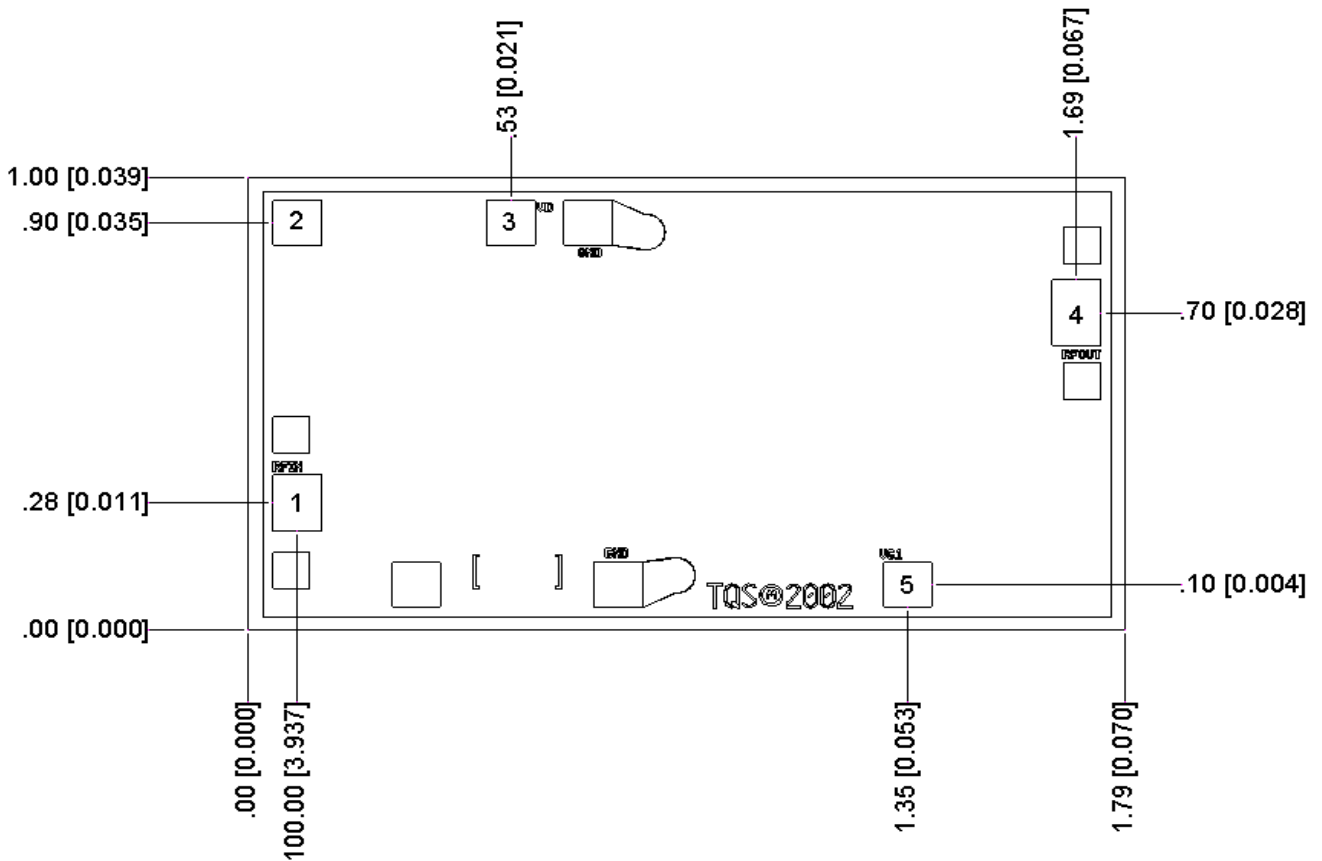

Units: millimeters [inches]

Thickness: 0.10 [0.004] (reference only)

Chip edge to bond pad dimensions are shown to center of bond pads.

Chip size tolerance: ± 0.05 [0.002]

RF ground through backside

Bond Pad #1	RF Input	0.10 x 0.13	[0.004 x 0.005]
Bond Pad #2	VCTRL	0.10 x 0.10	[0.004 x 0.004]
Bond Pad #3	V+	0.10 x 0.10	[0.004 x 0.004]
Bond Pad #4	RF Output	0.10 x 0.13	[0.004 x 0.005]
Bond Pad #5	VG	0.10 x 0.10	[0.004 x 0.004]

Chip Assembly & Bonding Diagram

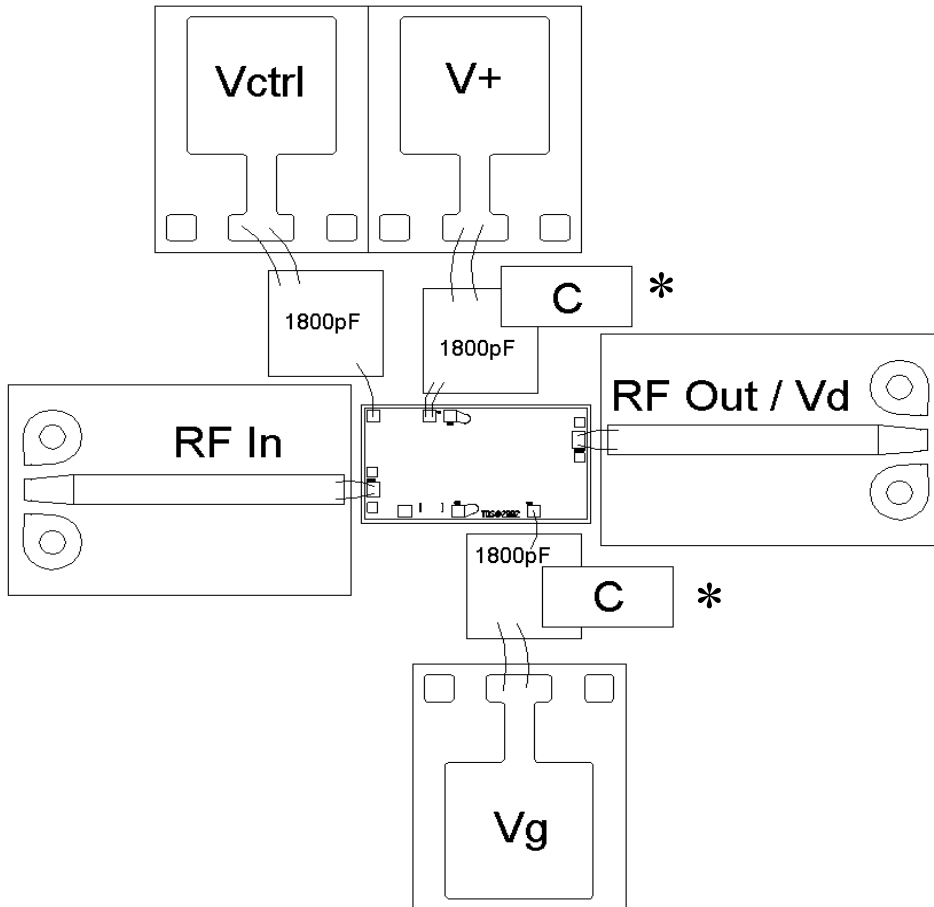

C	Bypassing Effective Lower Frequency
0	20 MHz
0.01uF	4 MHz
0.1uF	250kHz

Additional Biasing Information:

- Bias Conditions: $V^+ = 5.0 \text{ V}$, $I^+ = 50 \text{ mA}$
- Adjust V_{g1} for $I^+ = 50 \text{ mA}$
- Adjust V_{ctrl} for Gain and Eye crossing control. V_{ctrl} bias is optional.

* 1800pF & 0.1uF capacitors can be substituted with the following integrated capacitors:

Part Number	Manufacturer
GZ0SYC104KJ8182MAW	AVX
VB4080X7R105Z16VHX182	Presidio

GaAs MMIC devices are susceptible to damage from Electrostatic Discharge. Proper precautions should be observed during handling, assembly and test.

Assembly Process Notes

Reflow process assembly notes:

- Use AuSn (80/20) solder with limited exposure to temperatures at or above 300°C. (30 seconds maximum)
- An alloy station or conveyor furnace with reducing atmosphere should be used.
- No fluxes should be utilized.
- Coefficient of thermal expansion matching is critical for long-term reliability.
- Devices must be stored in a dry nitrogen atmosphere.

Component placement and adhesive attachment assembly notes:

- Vacuum pencils and/or vacuum collets are the preferred method of pick up.
- Air bridges must be avoided during placement.
- The force impact is critical during auto placement.
- Organic attachment can be used in low-power applications.
- Curing should be done in a convection oven; proper exhaust is a safety concern.
- Microwave or radiant curing should not be used because of differential heating.
- Coefficient of thermal expansion matching is critical.

Interconnect process assembly notes:

- Thermosonic ball bonding is the preferred interconnect technique.
- Force, time, and ultrasonics are critical parameters.
- Aluminum wire should not be used.
- Maximum stage temperature is 200°C.

GaAs MMIC devices are susceptible to damage from Electrostatic Discharge. Proper precautions should be observed during handling, assembly and test.