

# TQP7M9104

## 2W High Linearity Amplifier



### Applications

- Repeaters
- BTS Transceivers
- BTS High Power Amplifiers
- CDMA / WCDMA / LTE
- General Purpose Wireless

### Product Features

- 700-2700 MHz
- +32.8 dBm P1dB
- +49.5 dBm Output IP3
- 15.8 dB Gain at 2140 MHz
- +5V Single Supply, 435 mA Collector Current
- Internal RF overdrive protection
- Internal DC overvoltage protection
- Internal Active Bias
- On chip ESD protection
- Shut-down Capability
- Capable of handling 10:1 VSWR at 5Vcc, 2.14 GHz, 32.8 dBm CW Pout or 23.5 dBm WCDMA Pout

### General Description

The TQP7M9104 is a high linearity driver amplifier in industry standard, RoHS compliant, QFN surface mount package. This InGaP/GaAs HBT delivers high performance across 700-2700 MHz range of frequencies with 15.8 dB Gain, +49.5 dBm OIP3 and +32.5 dBm P1dB at 2.14 GHz while only consuming 435 mA quiescent collector current. All devices are 100% RF and DC tested.

The TQP7M9104 incorporates on-chip features that differentiate it from other products in the market. The amplifier integrates an on-chip DC over-voltage and RF over-drive protection. This protects the amplifier from electrical DC voltage surges and high input RF input power levels that may occur in a system.

The TQP7M9104 is targeted for use as a driver amplifier in wireless infrastructure where high linearity, medium power, and high efficiency are required. The device is an excellent candidate for transceiver line cards and high power amplifiers in current and next generation multi-carrier 3G / 4G base stations.

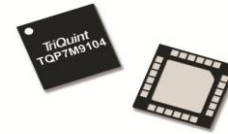

24-pin QFN 4x4mm SMT Package

### Functional Block Diagram

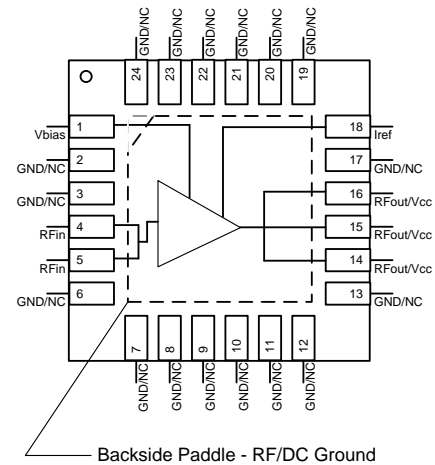

### Pin Configuration

Pin #	Symbol
1	Vbias
4, 5	RFIn
14, 15, 16	RFout/Vcc
18	Iref
2, 3, 6, 7, 8, 9, 10, 11, 12, 13, 17, 19, 20, 21, 22, 23, 24	GND / NC
Backside Paddle	RF/DC Ground

### Ordering Information

Part No.	Description
TQP7M9104	2W High Linearity Amplifier
TQP7M9104-PCB900	920-960MHz EVB
TQP7M9104-PCB2140	2.11-2.17GHz EVB

Standard T/R size =2500 pieces on a 13" reel.

# TQP7M9104

## 2W High Linearity Amplifier



### Specifications

#### Absolute Maximum Ratings

Parameter	Rating
Storage Temperature	-65 to +150°C
Device Voltage, $V_{CC}$	6.5 V
Maximum Input Power, CW	+30 dBm

Operation of this device outside the parameter ranges given above may cause permanent damage.

#### Recommended Operating Conditions

Parameter	Min	Typ	Max	Units
$V_{CC}$		+5	+5.25	V
$T_{case}$	-40		+85	°C
$T_j$ (for $>10^6$ hours MTTF)			170	°C

Electrical specifications are measured at specified test conditions.

Specifications are not guaranteed over all recommended operating conditions.

### Electrical Specifications

Test Conditions:  $V_{CC} = +5V$ ,  $I_{CQ} = 435$  mA,  $T = 25^\circ C$  using a TQP7M9104-PCB2140 application circuit.

Parameter	Conditions	Min	Typical	Max	Units
Operational Bandwidth		700		2700	MHz
Test Frequency			2140		MHz
Power Gain		14.3	15.8	17.3	dB
Input Return Loss			12		dB
Output Return Loss			9.5		dB
Output IP3	$P_{out} = +17$ dBm/tone, $\Delta f = 1$ MHz	+45.5	+49.5		dBm
WCDMA Channel Power <sup>(1)</sup>	at -50 dBc ACLR		+23.8		dBm
Output P1dB		+32	+32.8		dBm
Noise Figure			4.4		dB
Quiescent Collector Current, $I_{CQ}$		355	435	490	mA
$V_{CC}$			+5		V
$I_{ref}$			19		mA
Thermal Resistance (jnc to case) $\theta_{jc}$			15.7		°C/W

Notes:

1. ACLR Test set-up: 3GPP WCDMA, TM1+64 DPCH, +5 MHz offset, PAR = 9.7 dB at 0.01% Prob.

# TQP7M9104

## 2W High Linearity Amplifier



### Device Characterization Data

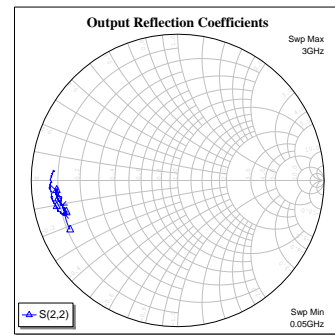
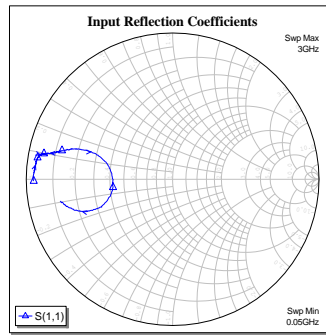
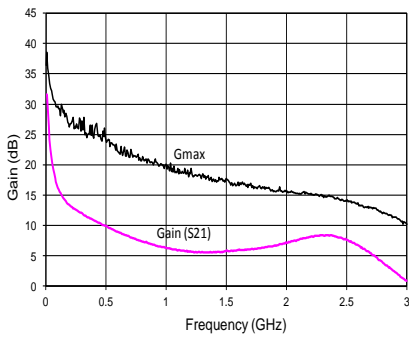

### S-Parameter Data

$V_{cc} = +5\text{ V}$ ,  $I_{cq} = 435\text{ mA}$ ,  $I_{ref} = 19\text{ mA}$ ,  $T = +25^\circ\text{ C}$ , unmatched 50 ohm system, calibrated to device leads

Freq (MHz)	S11 (dB)	S11 (ang)	S21 (dB)	S21 (ang)	S12 (dB)	S12 (ang)	S22 (dB)	S22 (ang)
50	-0.4553	-179.26	20.126	118.98	-43.273	4.1446	-1.8524	-155.37
100	-0.4348	178.69	15.971	124.23	-42.615	-1.4433	-1.8878	-166.21
200	-0.4583	176.36	13.24	126.46	-40.235	2.3772	-1.859	-172.01
400	-0.5124	173.38	10.778	118.38	-40.956	0.7196	-1.5792	-174.84
600	-0.5796	171.48	8.9263	108.51	-41.682	10.901	-1.6005	-175.51
800	-0.6594	170.04	7.3201	100.05	-42.533	-8.3414	-1.6164	-174.73
1000	-0.7617	169.21	6.2878	93.94	-42.841	6.4435	-1.531	-173.74
1200	-0.8777	168.95	5.7693	89.116	-40.461	3.1558	-1.6296	-171.43
1400	-1.1121	168.56	5.5556	83.209	-39.435	-0.2787	-1.7656	-170.12
1600	-1.4274	167.84	6.0222	74.67	-41.097	-1.3568	-1.8812	-167.74
1800	-1.9525	165.88	6.3509	63.971	-37.935	-22.971	-1.951	-165.22
2000	-3.0149	163.02	7.1412	51.862	-36.666	-37.917	-1.9853	-163.19
2200	-5.3234	162.27	8.1891	30.583	-35.423	-57.21	-1.7616	-163.18
2400	-7.8162	-179.65	8.2216	2.8455	-35.631	-78.615	-1.5099	-167.05
2600	-5.6951	-159.12	6.6099	-26.943	-35.017	-113.27	-1.2811	-172.58
2800	-3.2673	-161.75	3.8288	-51.412	-37.551	-151.24	-1.2268	-179.96
3000	-2.1416	-169.16	0.9043	-67.725	-39.417	-168.38	-1.4503	175.32

# TQP7M9104

## 2W High Linearity Amplifier



### Reference Design 869-894 MHz

Typical Performance at 25 °C

Frequency (MHz)	869	880	894	Units
Gain	20.8	20.8	20.8	dB
Input Return Loss	-13.3	-13	-11.5	dB
Output Return Loss	-7.7	-8.6	-9.8	dB
Output P1dB	+34.3	+34.1	+33.8	dBm
Output IP3 (+23 dBm/1tone, Δf = 1 MHz)	+44.9	+44.9	+44.7	dBm
WCDMA Channel Power (at -50 dBc ACLR)	22	22.5	23	dB
Supply Voltage, Vcc	+5			V
Quiescent Current, Icq	435			mA
Reference Current, Iref	19			mA

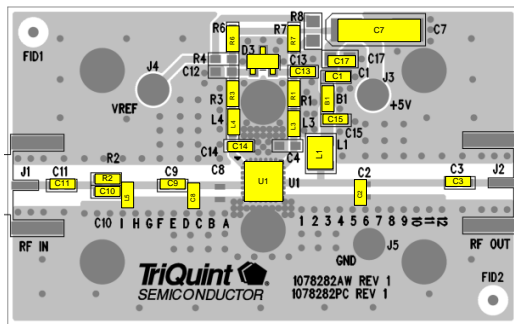
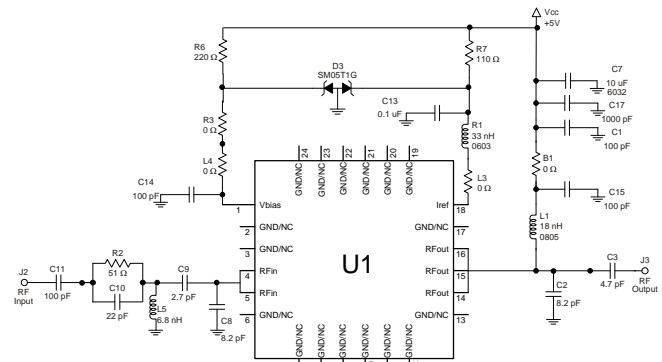

#### Notes:

- Components shown on the silkscreen but not on the schematic are not used.
- 0 Ω resistors may be replaced with copper trace in the target application layout.
- Iref can be used as device power down current by placing R7 at location R8.
- The recommended component values are dependent upon the frequency of operation.
- All components are of 0603 size unless stated on the schematic.
- R1 is critical for device linearity performance.
- Critical component placement locations:  
 Distance between center of C8 and U1 device package is 243 mil (11° at 880MHz)  
 Distance between center of L5 and U1 device package is 452 mil (20.5° at 880MHz)  
 Distance between center of C2 and U1 device package is 355 mil (16.1° at 880MHz)  
 Distance between center of C9 and U1 device package is 275 mil (12.4° at 880MHz)

### RF Performance Plots 869-894 MHz

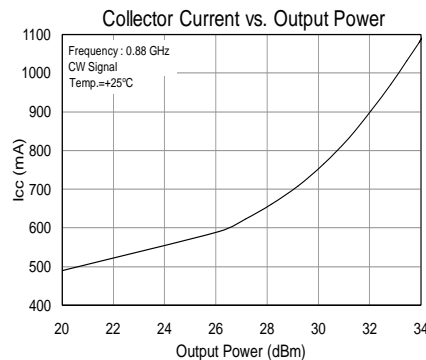
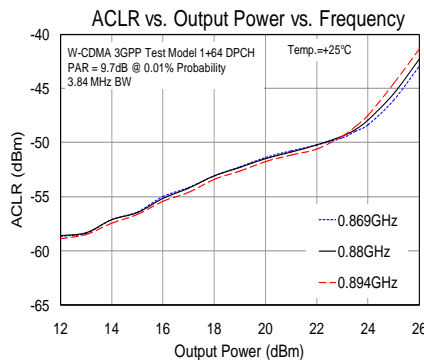
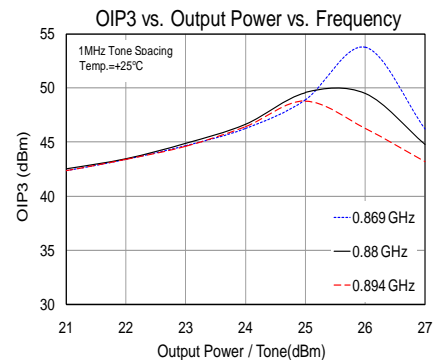
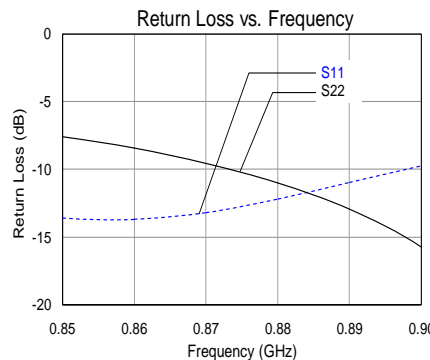
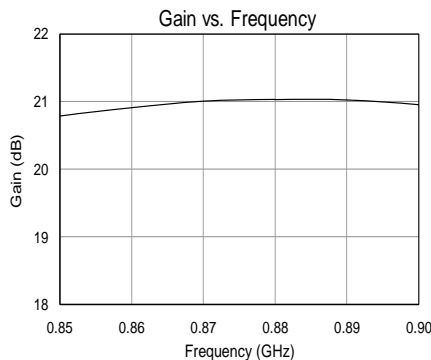

# TQP7M9104

## 2W High Linearity Amplifier



### Application Circuit 920-960 MHz (TQP7M9104-PCB900)

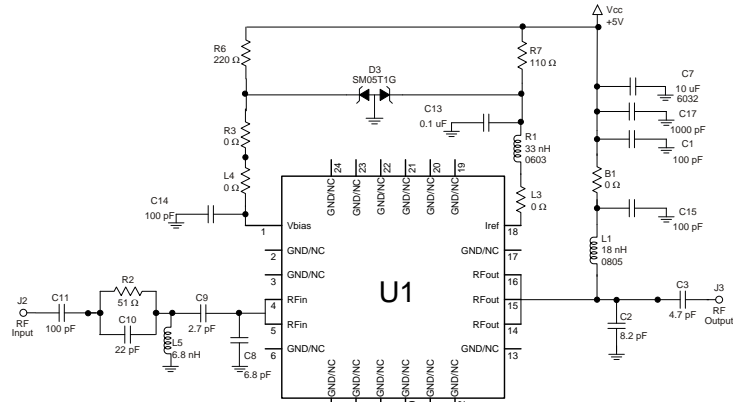
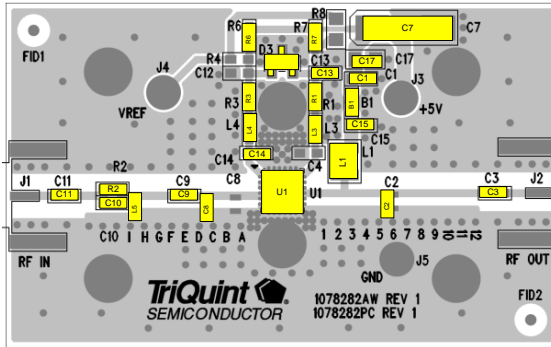

#### Notes:

1. See PC Board Layout under Application Information section for more information.
2. Components shown on the silkscreen but not on the schematic are not used.
3. 0 Ω resistors may be replaced with copper trace in the target application layout.
4. Iref can be used as device power down current by placing R7 at location R8.
5. The recommended component values are dependent upon the frequency of operation.
6. All components are of 0603 size unless stated on the schematic.
7. R1 is critical for device linearity performance.
8. Critical component placement locations:  
 Distance between center of C8 and U1 device package is 190 mil (9.2° at 940MHz)  
 Distance between center of L5 and U1 device package is 452 mil (21.8° at 940MHz)  
 Distance between center of C2 and U1 device package is 305 mil (14.7° at 940MHz)  
 Distance between center of C9 and U1 device package is 275 mil (13.3° at 940MHz)

### Bill of Material

Ref Des	Value	Description	Manuf.	Part Number
n/a	n/a	Printed Circuit Board	TriQuint	1078282
n/a	n/a	Printed Circuit Board	TriQuint	1078282
D3	n/a	Zener, dual, SOT-23	various	
C9	2.7 pF	Capacitor, Chip, 0603, ±0.05pF, 50 V, Accu-P	AVX	06035J2R7ABSTR
B1, L3, L4, R3	0 Ω	Resistor, Chip, 0603, 5%, 1/16W	various	
L5	6.8 nH	Inductor, 0603, 5%	Toko	LL1608-FSL6N8
C3	4.7 pF	Capacitor, Chip, 0603, ±0.05pF, 50 V, Accu-P	AVX	06035J4R7ABSTR
C2, C8	8.2 pF	Capacitor, Chip, 0603, ±0.05pF, 50 V, Accu-P	AVX	06035J8R2ABSTR
C10	22 pF	Capacitor, Chip, 0603, 5%, 50 V, NPO/COG	various	
C1, C11, C14, C15	100 pF	Capacitor, Chip, 0603, 5%, 50V, NPO/COG	various	
L1	18 nH	Inductor, 1008, 5%, Coilcraft CS Series	Coilcraft	1008HQ-18NXJL
C17	1000 pF	Capacitor, Chip, 0603, 10%, 50V, NPO/COG	various	
C13	0.1 uF	Capacitor, Chip, 0603, 50V, X5R, 10%	various	
C7	10 uF	Capacitor, Tantalum, 6032, 35V, 10%	various	
R2	51 Ω	Resistor, Chip, 0603, 5%, 1/16W	various	
R6	220 Ω	Resistor, Chip, 0603, 1%, 1/16W	various	
R7	110 Ω	Resistor, Chip, 0603, 1%, 1/16W	various	
R1	33 nH	Inductor, 0603, 5%	Toko	LL1608-FSL33N
R8, R4, C12, C4, D3	n/a	Do Not Place		

# TQP7M9104

## 2W High Linearity Amplifier



### Typical Performance 920-960 MHz

Typical Performance at 25 °C

Frequency (MHz)	920	940	960	Units
Gain	20.8	21	21	dB
Input Return Loss	-13	-12	-11	dB
Output Return Loss	-9	-11.8	-15	dB
Output P1dB	+33.9	+33.8	+33.4	dBm
Output IP3 (+23 dBm/tone, Δf = 1 MHz)	+45	+45	+45	dBm
WCDMA Channel power (at -50 dBc ACLR) [1]	+24	+23.5	+23	dBm
Supply Voltage, Vcc	+5			V
Quiescent Collector Current, Icq	435			mA
Reference Current, Iref	19			mA

Notes:

1. ACLR Test set-up: 3GPP WCDMA, TM1+64 DPCH, +5 MHz offset, PAR = 9.7 dB at 0.01% Prob.

### RF Performance Plots 920-960 MHz

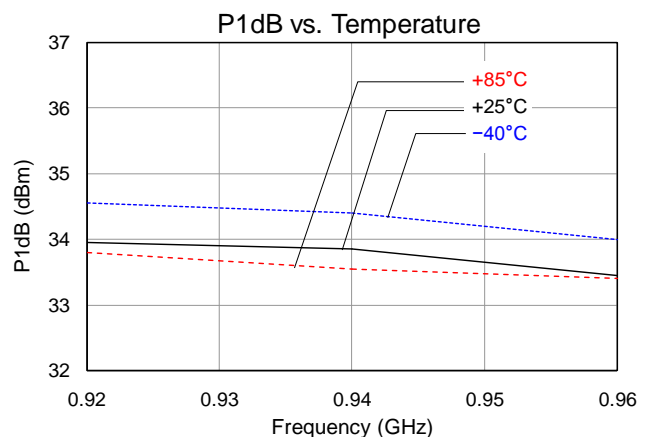
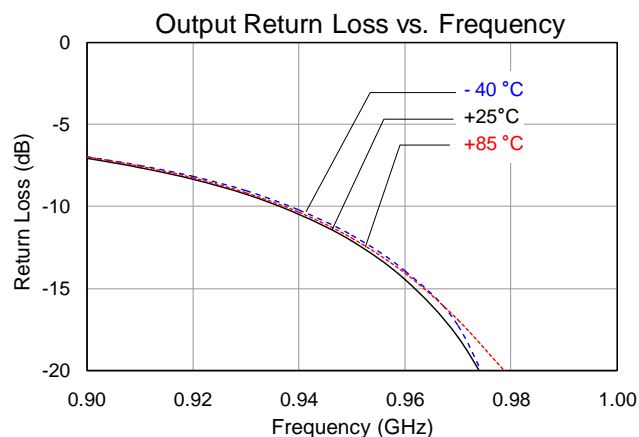
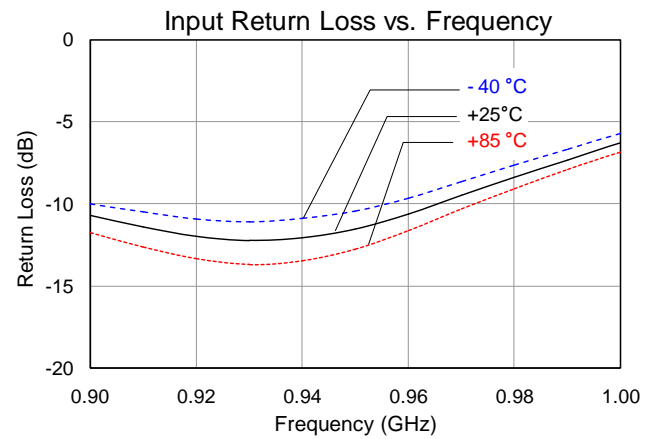
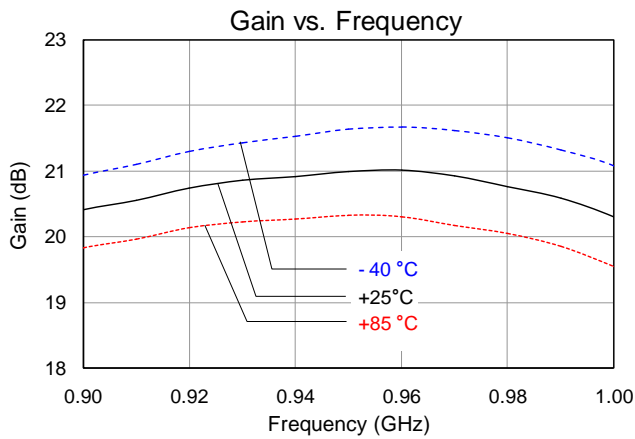



# TQP7M9104

## 2W High Linearity Amplifier

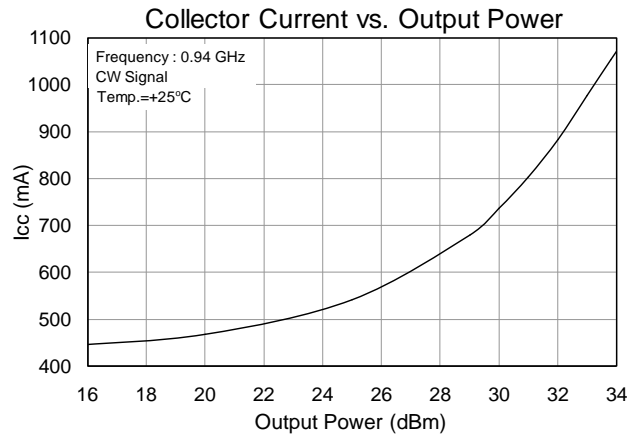
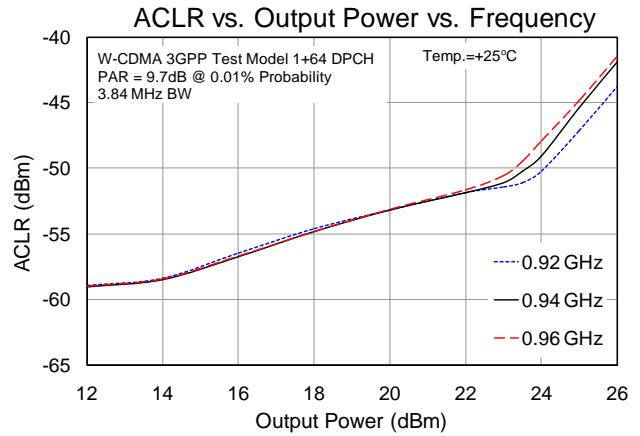
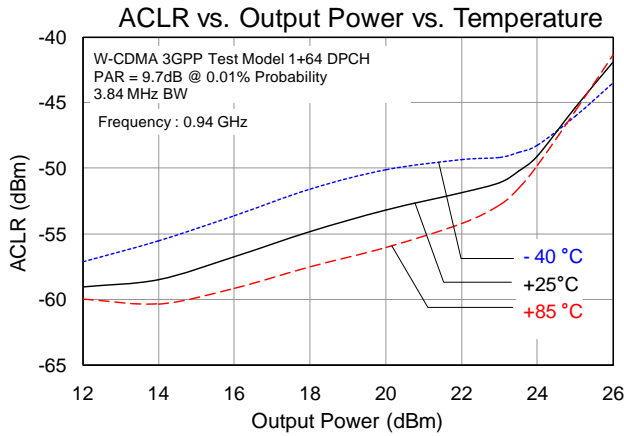
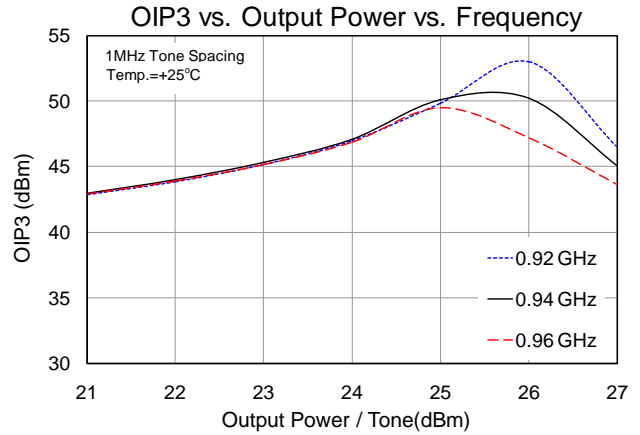
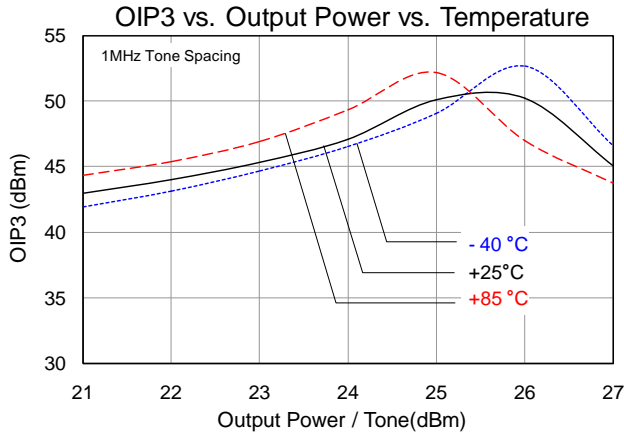

# TQP7M9104

## 2W High Linearity Amplifier



### Application Circuit 2110-2170 MHz (TQP7M9104-PCB2140)

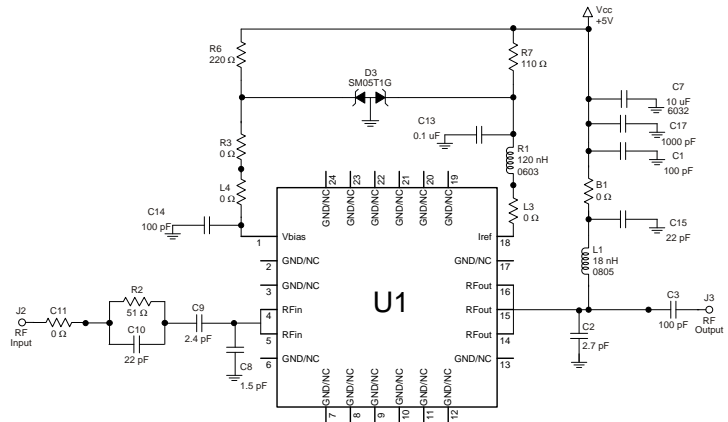
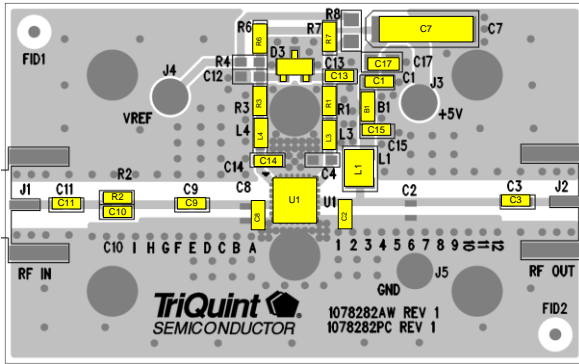

**Notes:**

1. See PC Board Layout under Application Information section for more information.
2. Components shown on the silkscreen but not on the schematic are not used.
3. 0 Ω resistors may be replaced with copper trace in the target application layout.
4. Iref can be used as device power down current by placing R7 at location R8.
5. The recommended component values are dependent upon the frequency of operation.
6. All components are of 0603 size unless stated on the schematic.
7. R1 is critical for device linearity performance.
8. Critical component placement locations:  
 Distance between center of C8 and U1 device package is 50 mil (5.5° at 2140MHz)  
 Distance between center of C2 and U1 device package is 113 mil (12.4° at 2140MHz)  
 Distance between center of C9 and U1 device package is 275 mil (30.3° at 2140MHz)

### Bill of Material

Ref Des	Value	Description	Manuf.	Part Number
U1	n/a	2W High Linearity Amplifier	TriQuint	TQP7M9104
n/a	n/a	Printed Circuit Board	TriQuint	1078282
D3	n/a	Zener, dual, SOT-23	various	
C8	1.5 pF	Capacitor, Chip, 0603, ±0.05pF, 50V, Accu-P	AVX	06035J1R5ABSTR
C9	2.4 pF	Capacitor, Chip, 0603, ±0.05pF, 50V, Accu-P	AVX	06035J2R4ABSTR
C2	2.7 pF	Capacitor, Chip, 0603, ±0.05pF, 50V, Accu-P	AVX	06035J2R7ABSTR
B1, L3, L4, R3, C11	0 Ω	Resistor, Chip, 0603, 5%, 1/16W	various	
C10, C15	22 pF	Capacitor, Chip, 0603, 5%, 50V, NPO/COG	various	
C1, C14, C3	100 pF	Capacitor, Chip, 0603, 5%, 50V, NPO/COG	various	
L1	18 nH	Inductor, 1008, 5%, Ceramic	Coilcraft	1008HQ-18NXJL
C17	1000 pF	Capacitor, Chip, 0603, 10%, 50V, NPO/COG	various	
C13	0.1 uF	Capacitor, Chip, 0603, 10%, 50V, X5R	various	
C7	10 uF	Capacitor, Tantalum, 6032, 20 %, 50V	various	
R2	51 Ω	Resistor, Chip, 0603, 5%, 1/16W	various	
R6	220 Ω	Resistor, Chip, 0603, 1%, 1/16W	various	
R7	110 Ω	Resistor, Chip, 0603, 1%, 1/16W	various	
R1	120 nH	Inductor, 0603, 5%	Toko	LL1608-FSR12J
R8, R4, C12, C4, D3	n/a	Do Not Place		



# TQP7M9104

## 2W High Linearity Amplifier



### Typical Performance 2110-2170 MHz

Frequency	MHz	2110	2140	2170
Gain	dB	15.8	15.8	15.8
Input Return Loss	dB	-12.4	-12.0	-11.8
Output Return Loss	dB	-8.7	-9.5	-10.5
Output P1dB	dBm	+32.9	+32.8	+32.8
Output IP3 (+17 dBm/tone, $\Delta f = 1$ MHz)	dBm	+49	+49.5	+50
WCDMA Channel power (at -50 dBc ACLR) [1]	dBm	+23.5	+23.8	+24.0
Noise Figure	dB	4.4	4.4	4.6
Supply Voltage, Vcc	V	+5		
Quiescent Collector Current, Icq	mA	435		
Reference Current, Iref	mA	19		

Notes:

1. ACLR Test set-up: 3GPP WCDMA, TM1+64 DPCH, +5 MHz offset, PAR = 9.7 dB at 0.01% Prob.

### RF Performance Plots 2110-2170 MHz

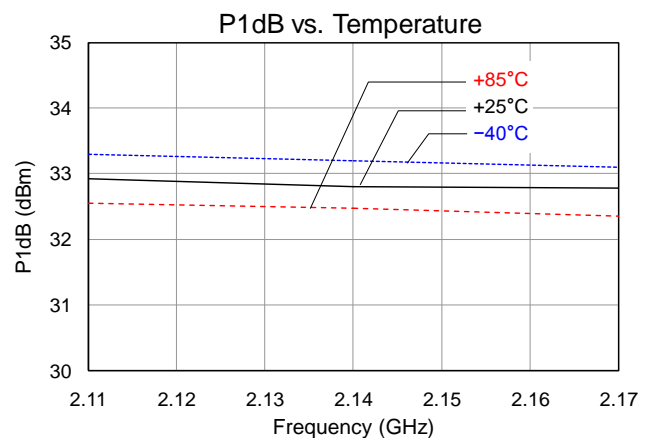
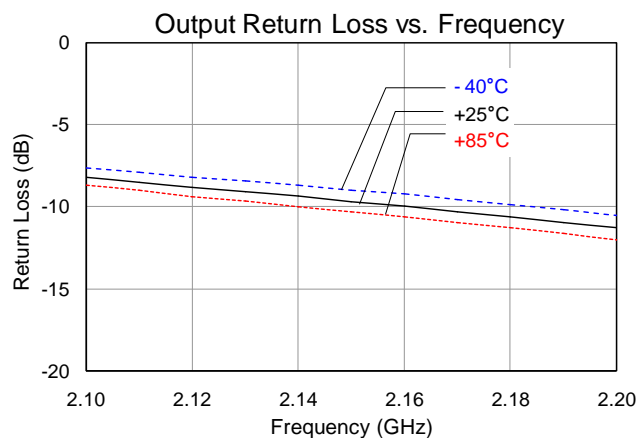
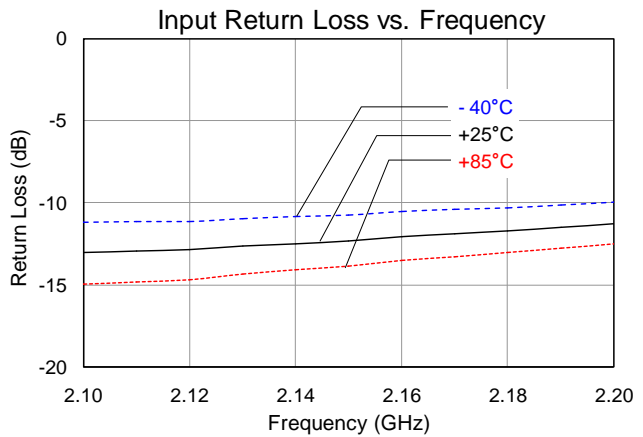
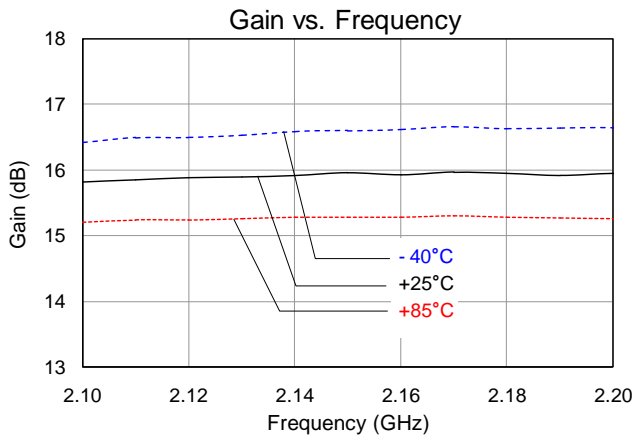

# TQP7M9104

## 2W High Linearity Amplifier

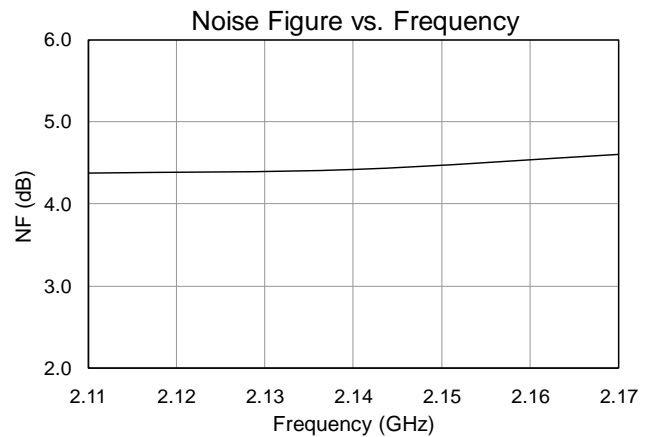
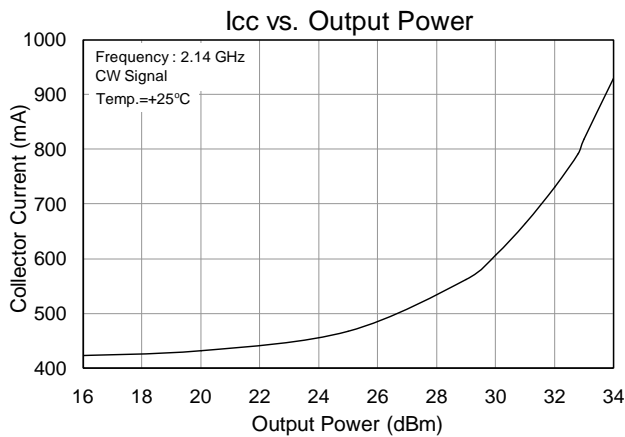
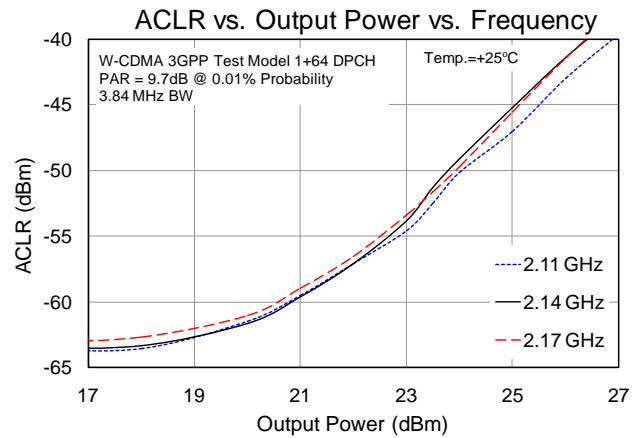
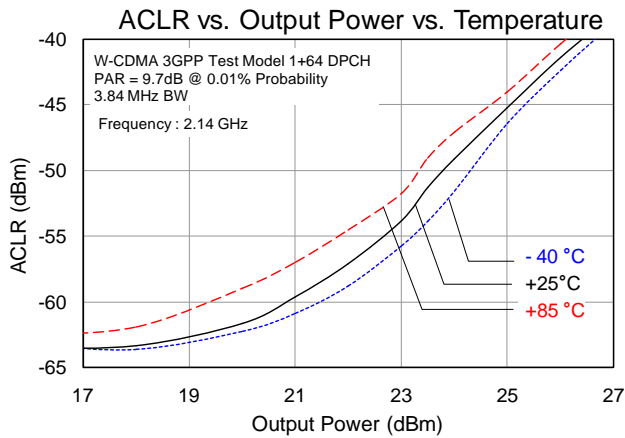
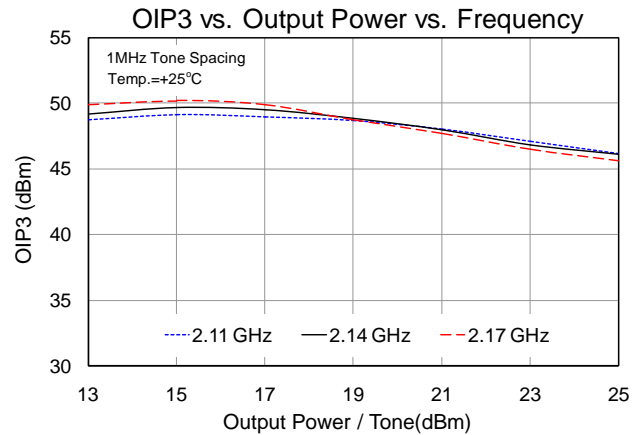
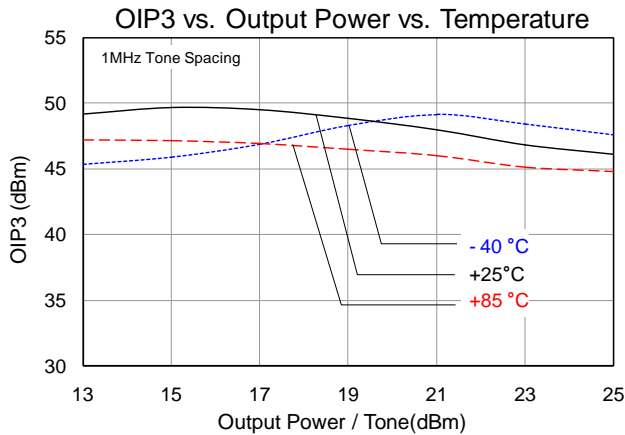

# TQP7M9104

## 2W High Linearity Amplifier



### Pin Configuration and Description

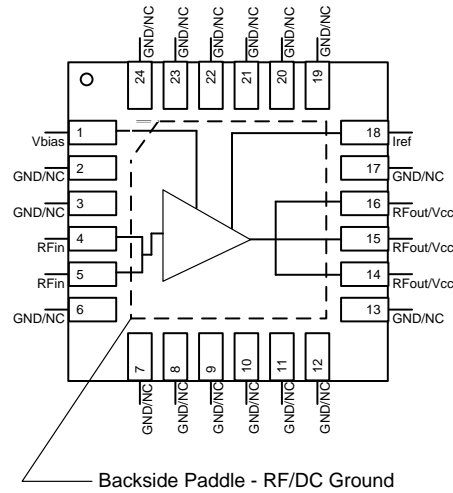

Pin	Symbol	Description
1	Vbias	Voltage supply for active bias for the amp. Connect to same supply voltage as Vcc.
2, 3, 6, 7, 8, 9, 10, 11, 12, 13, 17, 19, 20, 21, 22, 23, 24	GND/NC	No internal connection. This pin can be grounded or N/C on PCB. Land pads should be provided for PCB mounting integrity.
4, 5	RFin	RF Input. DC voltage present, blocking capacitor required. Requires external match for optimal performance.
14, 15, 16	RFout / Vcc	RF Output. DC Voltage present, blocking cap required. Requires external match for optimal performance.
18	Iref	Reference current into internal active bias current mirror. Current into Iref sets device quiescent current. Also, can be used as on/off control.
Backside paddle	RF/DC GND	Multiple Vias should be employed to minimize inductance and thermal resistance. Use recommended via pattern shown under mounting configuration and ensure good solder attach for optimum thermal and electrical performance

### Evaluation Board PCB Information

TriQuint PCB 1080068 Material and Stack-up

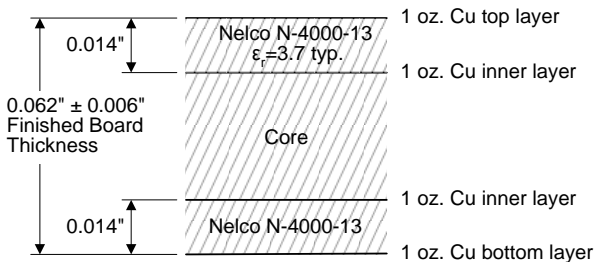

50 ohm line dimensions: width = .031"  
spacing = .035"

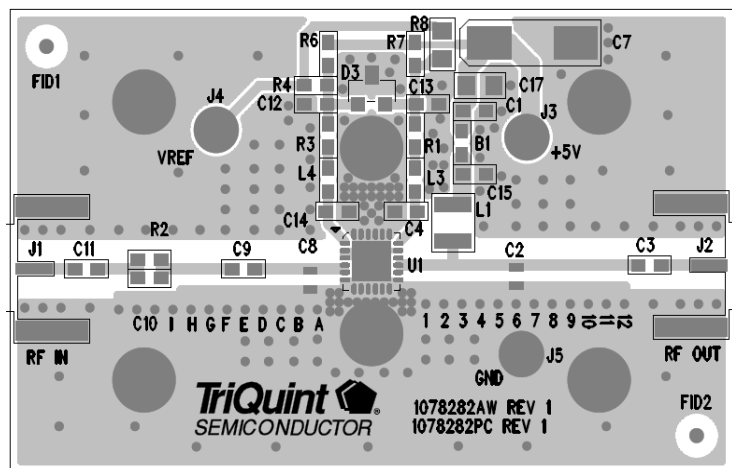

# TQP7M9104

## 2W High Linearity Amplifier



### Mechanical Information

### Package Marking and Dimensions

Package Marking:

Part number – 7M9104  
 Year, week - YYWW  
 Assembly code - XXXXX

NOTES:

- EXCEPT WHERE NOTED, THIS PART OUTLINE CONFORMS TO JEDEC STANDARD MO-220, ISSUE E (VARIATION VGGC) FOR THERMALLY ENHANCED PLASTIC VERY THIN FINE PITCH QUAD FLAT NO LEAD PACKAGE (QFN).
- DIMENSIONING & TOLERANCING CONFORM TO ASME Y14.4M-1994.
- ALL DIMENSIONS ARE IN MILLIMETERS. ANGLES ARE IN DEGREES.
- THE TERMINAL #1 IDENTIFIER AND TERMINAL NUMBERING CONVENTION CONFORM TO JEDEC 95-1 SPP-012.
- COPLANARITY APPLIES TO THE EXPOSED GROUND/THERMAL PAD AS WELL AS THE TERMINALS.
- PACKAGE BODY LENGTH/WIDTH DOES NOT INCLUDE PLASTIC FLASH PROTRUSION ACROSS MOLD PARTING LINE.
- DEVIATION FROM JEDEC STANDARD MO-229, ISSUE C, 12 LEAD COUNT NOT

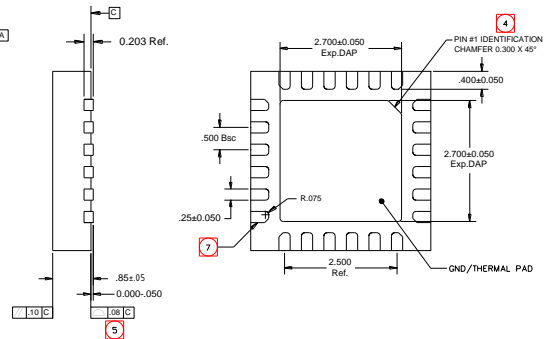
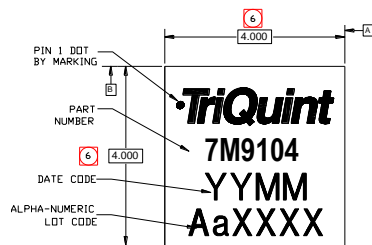

### PCB Mounting Pattern

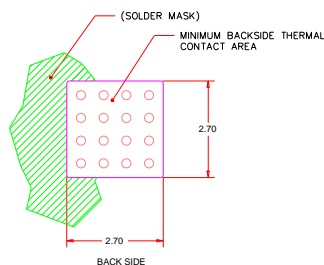
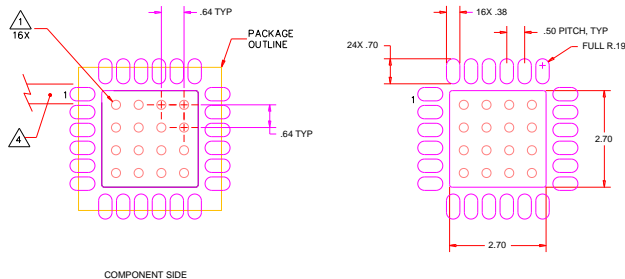

NOTES:

- GROUND/THERMAL VIAS ARE CRITICAL FOR THE PROPER PERFORMANCE OF THIS DEVICE. VIAS SHOULD USE A .35mm (#80/.0135") DIAMETER DRILL AND HAVE A FINAL, PLATED THRU DIAMETER OF .25mm (.010").
- ADD AS MUCH COPPER AS POSSIBLE TO INNER AND OUTER LAYERS NEAR THE PART TO ENSURE OPTIMAL THERMAL PERFORMANCE.
- TO ENSURE RELIABLE OPERATION, DEVICE GROUND PADDLE-TO-GROUND PAD SOLDER JOINT IS CRITICAL.
- RF TRACE WIDTH DEPENDS UPON THE PC BOARD MATERIAL AND CONSTRUCTION.
- USE 1 OZ. COPPER MINIMUM.
- ALL DIMENSIONS ARE IN MILLIMETERS. ANGLES ARE IN DEGREES.

NOTES:

- The pad pattern shown has been developed and tested for optimized assembly at TriQuint Semiconductor. The PCB land pattern has been developed to accommodate lead and package tolerances. Since surface mount processes vary from supplier to supplier, careful process development is recommended.
- All dimensions are in millimeters [inches]. Angles are in degrees.
- Use 1 oz. copper minimum for top and bottom layer metal.
- Vias are required under the backside paddle of this device for proper RF/DC grounding and thermal dissipation. We recommend a 0.35mm (#80/.0135") diameter bit for drilling via holes and a final plated thru diameter of 0.25mm (0.10").
- Ensure good package backside paddle solder attach for reliable operation and best electrical performance.
- Place mounting screws near the part to fasten a back side heat sink.
- Do not apply solder mask to the back side of the PC board in the heat sink contact region.
- Ensure that the backside via region makes good physical contact with the heat sink.

### Product Compliance Information

#### ESD Sensitivity Ratings



**Caution! ESD-Sensitive Device**

ESD Rating: 1C  
Value:  $\geq 1000$  V and  $< 2000$  V  
Test: Human Body Model (HBM)  
Standard: JEDEC Standard JESD22-A114

ESD Rating: IV  
Value:  $\geq 1000$  V min  
Test: Charged Device Model (CDM)  
Standard: JEDEC Standard JESD22-C101

#### MSL Classification

MSL Rating: 1  
Test: +260 °C convection reflow  
Standard: JEDEC standard IPC/JEDEC J-STD-020

#### Solderability

Compatible with both lead-free (260 °C max. reflow temp.) and tin/lead (245 °C max. reflow temp.) soldering processes.

Package lead plating: Annealed Matte Tin over Copper

#### RoHS Compliance

This part is compliant with EU 2002/95/EC RoHS directive (Restrictions on the Use of Certain Hazardous Substances in Electrical and Electronic Equipment).

This product also has the following attributes:

- Lead Free
- Halogen Free (Chlorine, Bromine)
- Antimony Free
- TBBP-A (C<sub>15</sub>H<sub>12</sub>Br<sub>4</sub>O<sub>2</sub>) Free
- PFOS Free
- SVHC Free

### Contact Information

For the latest specifications, additional product information, worldwide sales and distribution locations, and information about TriQuint:

Web: [www.triquint.com](http://www.triquint.com)  
Email: [info-sales@tqs.com](mailto:info-sales@tqs.com)

Tel: +1.503.615.9000  
Fax: +1.503.615.8902

For technical questions and application information: Email: [sicapplications.engineering@tqs.com](mailto:sicapplications.engineering@tqs.com)

### Important Notice

The information contained herein is believed to be reliable. TriQuint makes no warranties regarding the information contained herein. TriQuint assumes no responsibility or liability whatsoever for any of the information contained herein. TriQuint assumes no responsibility or liability whatsoever for the use of the information contained herein. The information contained herein is provided "AS IS, WHERE IS" and with all faults, and the entire risk associated with such information is entirely with the user. All information contained herein is subject to change without notice. Customers should obtain and verify the latest relevant information before placing orders for TriQuint products. The information contained herein or any use of such information does not grant, explicitly or implicitly, to any party any patent rights, licenses, or any other intellectual property rights, whether with regard to such information itself or anything described by such information.

TriQuint products are not warranted or authorized for use as critical components in medical, life-saving, or life-sustaining applications, or other applications where a failure would reasonably be expected to cause severe personal injury or death.