

### FEATURES

- Micropower: 100  $\mu$ A**
- 0.1  $\mu$ A typical power shutdown**
- Single-supply 2.7 V to 5.5 V operation**
- AD7392: 12-bit resolution**
- AD7393: 10-bit resolution**
- 0.9 LSB differential nonlinearity error**

### APPLICATIONS

- Automotive 0.5 V to 4.5 V output span voltage**
- Portable communications**
- Digitally controlled calibration**
- PC peripherals**

### GENERAL DESCRIPTION

The AD7392/AD7393 comprise a set of pin-compatible 10-/12-bit voltage output, digital-to-analog converters. The parts are designed to operate from a single 3 V supply. Built using a CBCMOS process, these monolithic DACs offer low cost and ease of use in single-supply 3 V systems. Operation is guaranteed over the supply voltage range of 2.7 V to 5.5 V, making this device ideal for battery-operated applications.

The full-scale voltage output is determined by the external reference input voltage applied. The rail-to-rail  $REF_{IN}$  to  $DAC_{OUT}$  allows a full-scale voltage equal to the positive supply  $V_{DD}$  or any value in between. The voltage outputs are capable of sourcing 5 mA.

A data latch load of 12 bits with a 45 ns write time eliminates wait states when interfacing to the fastest processors. Additionally, an asynchronous  $RS$  input sets the output to a zero scale at power-on or upon user demand.

### FUNCTIONAL BLOCK DIAGRAM

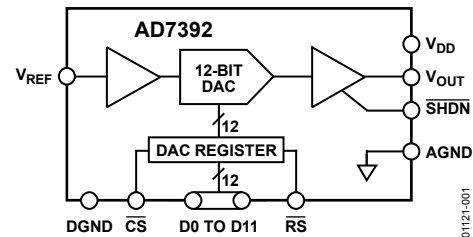

Figure 1.

Both parts are offered with similar pinouts, which allows users to select the amount of resolution appropriate for their applications without changing the circuit card.

The AD7392/AD7393 are specified for operation over the extended industrial temperature range of  $-40^{\circ}\text{C}$  to  $+85^{\circ}\text{C}$ . The AD7393AR is specified for the automotive temperature range of  $-40^{\circ}\text{C}$  to  $+125^{\circ}\text{C}$ . The AD7392/AD7393 are available in 20-lead PDIP and 20-lead SOIC packages.

For serial data input, 8-lead packaged versions, see the AD7390 and AD7391.

#### Rev. C

Information furnished by Analog Devices is believed to be accurate and reliable. However, no responsibility is assumed by Analog Devices for its use, nor for any infringements of patents or other rights of third parties that may result from its use. Specifications subject to change without notice. No license is granted by implication or otherwise under any patent or patent rights of Analog Devices. Trademarks and registered trademarks are the property of their respective owners.

## TABLE OF CONTENTS

Features .....	1	Digital-to-Analog Converters.....	12
Applications.....	1	Amplifier Section .....	12
Functional Block Diagram .....	1	Reference Input.....	12
General Description .....	1	Power Supply.....	13
Revision History .....	2	Input Logic Levels .....	13
Specifications.....	3	Digital Interface .....	13
Electrical Characteristics .....	3	Reset Pin ( $\overline{RS}$ ) .....	14
Timing Diagram .....	5	Power Shutdown ( $\overline{SHDN}$ ).....	14
Absolute Maximum Ratings.....	6	Unipolar Output Operation.....	14
ESD Caution.....	6	Bipolar Output Operation.....	15
Pin Configurations and Function Descriptions .....	7	Outline Dimensions .....	16
Typical Performance Characteristics .....	8	Ordering Guide .....	17
Theory of Operation .....	12		

## REVISION HISTORY

### 8/07—Rev. B to Rev. C

Changes to Specifications Section .....	3
Changes to Table 3.....	6
Changes to Theory of Operation Section.....	12
Changes to Figure 29.....	13
Changes to Figure 32.....	14
Changes to Figure 33.....	15
Updated Outline Dimensions .....	16
Changes to Ordering Guide .....	17

### 6/04—Changed from Rev. A to Rev. B

Removed TSSOP.....	Universal
Changes to Ordering Guide .....	17

### 3/99—Changed from Rev. 0 to Rev. A

### 11/96—Revision 0: Initial Version

# SPECIFICATIONS

## ELECTRICAL CHARACTERISTICS

At  $V_{REF} = 2.5\text{ V}$ ,  $-40^{\circ}\text{C} < T_A < +85^{\circ}\text{C}$ , unless otherwise noted.

Table 1. AD7392

Parameter	Symbol	Conditions	3 V $\pm$ 10%	5 V $\pm$ 10%	Unit
STATIC PERFORMANCE					
Resolution <sup>1</sup>	N		12	12	Bits
Relative Accuracy <sup>2</sup>	INL	$T_A = +25^{\circ}\text{C}$ $T_A = -40^{\circ}\text{C}, +85^{\circ}\text{C}$	$\pm 1.8$ $\pm 3$	$\pm 1.8$ $\pm 3$	LSB max LSB max
Differential Nonlinearity <sup>2</sup>	DNL	$T_A = +25^{\circ}\text{C}$ , monotonic Monotonic	$\pm 0.9$ $\pm 1$	$\pm 0.9$ $\pm 1$	LSB max LSB max
Zero-Scale Error	$V_{ZSE}$	Data = 0x000, $T_A = +25^{\circ}\text{C}, +85^{\circ}\text{C}$ Data = 0x000, $T_A = -40^{\circ}\text{C}$	4.0 8.0	4.0 8.0	mV max mV max
Full-Scale Voltage Error	$V_{FSE}$	$T_A = +25^{\circ}\text{C}, +85^{\circ}\text{C}$ , data = 0xFFFF $T_A = -40^{\circ}\text{C}$ , data = 0xFFFF	$\pm 8$ $\pm 20$	$\pm 8$ $\pm 20$	mV max mV max
Full-Scale Temperature Coefficient <sup>3</sup>	$TCV_{FS}$		28	28	ppm/ $^{\circ}\text{C}$ typ
REFERENCE INPUT					
$V_{REF}$ Range	$V_{REF}$		0/ $V_{DD}$	0/ $V_{DD}$	V min/max
Input Resistance	$R_{REF}$		2.5	2.5	M $\Omega$ typ <sup>4</sup>
Input Capacitance <sup>3</sup>	$C_{REF}$		5	5	pF typ
ANALOG OUTPUT					
Current (Source)	$I_{OUT}$	Data = 0x800, $\Delta V_{OUT} = 5\text{ LSB}$	1	1	mA typ
Output Current (Sink)	$I_{OUT}$	Data = 0x800, $\Delta V_{OUT} = 5\text{ LSB}$	3	3	mA typ
Capacitive Load <sup>3</sup>	$C_L$	No oscillation	100	100	pF typ
LOGIC INPUTS					
Logic Input Low Voltage	$V_{IL}$		0.5	0.8	V max
Logic Input High Voltage	$V_{IH}$		$V_{DD} - 0.6$	$V_{DD} - 0.6$	V min
Input Leakage Current	$I_{IL}$		10	10	$\mu\text{A}$ max
Input Capacitance <sup>3</sup>	$C_{IL}$		10	10	pF max
INTERFACE TIMING <sup>3,5</sup>					
Chip Select Write Width	$t_{CS}$		45	45	ns min
Data Setup	$t_{DS}$		30	15	ns min
Data Hold	$t_{DH}$		20	5	ns min
Reset Pulse Width	$t_{RS}$		40	30	ns min
AC CHARACTERISTICS					
Output Slew Rate	SR	Data = 0x000 to 0xFFFF to 0x000	0.05	0.05	V/ $\mu\text{s}$ typ
Settling Time <sup>6</sup>	$t_s$	To $\pm 0.1\%$ of full scale	70	60	$\mu\text{s}$ typ
Shutdown Recovery Time	$t_{SDR}$			80	$\mu\text{s}$ typ
DAC Glitch		Code 0x7FF to Code 0x800 to Code 0x7FF	65	65	nV/s typ
Digital Feedthrough			15	15	nV/s typ
Feedthrough	$V_{OUT}/V_{REF}$	$V_{REF} = 1.5\text{ V dc} + 1\text{ V p-p}$ , data = 0x000, $f = 100\text{ kHz}$	-63	-63	dB typ
SUPPLY CHARACTERISTICS					
Power Supply Range	$V_{DD\text{ RANGE}}$	DNL $< \pm 1\text{ LSB}$	2.7/5.5	2.7/5.5	V min/max
Positive Supply Current	$I_{DD}$	$V_{IL} = 0\text{ V}$ , no load	55/100	55/100	$\mu\text{A}$ typ/max
Shutdown Supply Current	$I_{DD-SD}$	$\overline{\text{SHDN}} = 0$ , $V_{IL} = 0\text{ V}$ , no load	0.1/1.5	0.1/1.5	$\mu\text{A}$ typ/max
Power Dissipation	$P_{DISS}$	$V_{IL} = 0\text{ V}$ , no load	300	500	$\mu\text{W}$ max
Power Supply Sensitivity	PSS	$\Delta V_{DD} = \pm 5\%$	0.006	0.006	%/% max

<sup>1</sup> One LSB =  $V_{REF}/4096\text{ V}$  for the 12-bit AD7392.

<sup>2</sup> The first two codes (0x000, 0x001) are excluded from the linearity error measurement.

<sup>3</sup> These parameters are guaranteed by design and not subject to production testing.

<sup>4</sup> Typicals represent average readings measured at  $+25^{\circ}\text{C}$ .

<sup>5</sup> All input control signals are specified with  $t_r = t_f = 2\text{ ns}$  (10% to 90% of 13 V) and timed from a voltage level of 1.6 V.

<sup>6</sup> The settling time specification does not apply for negative going transitions within the last 3 LSBs of ground.

# AD7392/AD7393

At  $V_{REF} = 2.5\text{ V}$ ,  $-40^{\circ}\text{C} < T_A < +85^{\circ}\text{C}$ , unless otherwise noted.

**Table 2. AD7393**

Parameter	Symbol	Conditions	3 V $\pm$ 10%	5 V $\pm$ 10%	Unit
<b>STATIC PERFORMANCE</b>					
Resolution <sup>1</sup>	N		10	10	Bits
Relative Accuracy <sup>2</sup>	INL	$T_A = +25^{\circ}\text{C}$ $T_A = -40^{\circ}\text{C}, +85^{\circ}\text{C}, +125^{\circ}\text{C}$	$\pm 1.75$ $\pm 2.0$	$\pm 1.75$ $\pm 2.0$	LSB max LSB max
Differential Nonlinearity <sup>2</sup>	DNL	Monotonic	$\pm 0.8$	$\pm 0.8$	LSB max
Zero-Scale Error	$V_{ZSE}$	Data = 0x000	9.0	9.0	mV max
Full-Scale Voltage Error	$V_{FSE}$	$T_A = +25^{\circ}\text{C}, +85^{\circ}\text{C}, +125^{\circ}\text{C}$ , data = 0x3FF $T_A = -40^{\circ}\text{C}$ , data = 0x3FF	$\pm 32$ $\pm 42$	$\pm 32$ $\pm 42$	mV max mV max
Full-Scale Temperature Coefficient <sup>3</sup>	$TCV_{FS}$		28	28	ppm/ $^{\circ}\text{C}$ typ
<b>REFERENCE INPUT</b>					
$V_{REF}$ IN Range	$V_{REF}$		0/ $V_{DD}$	0/ $V_{DD}$	V min/max
Input Resistance	$R_{REF}$		2.5	2.5	M $\Omega$ typ <sup>4</sup>
Input Capacitance <sup>3</sup>	$C_{REF}$		5	5	pF typ
<b>ANALOG OUTPUT</b>					
Output Current (Source)	$I_{OUT}$	Data = 0x200, $\Delta V_{OUT} = 5\text{ LSB}$	1	1	mA typ
Output Current (Sink)	$I_{OUT}$	Data = 0x200, $\Delta V_{OUT} = 5\text{ LSB}$	3	3	mA typ
Capacitive Load <sup>3</sup>	$C_L$	No oscillation	100	100	pF typ
<b>LOGIC INPUTS</b>					
Logic Input Low Voltage	$V_{IL}$		0.5	0.8	V max
Logic Input High Voltage	$V_{IH}$		$V_{DD} - 0.6$	$V_{DD} - 0.6$	V min
Input Leakage Current	$I_{IL}$		10	10	$\mu\text{A}$ max
Input Capacitance <sup>3</sup>	$C_{IL}$		10	10	pF max
<b>INTERFACE TIMING<sup>3,5</sup></b>					
Chip Select Write Width	$t_{CS}$		45	45	ns
Data Setup	$t_{DS}$		30	15	ns
Data Hold	$t_{DH}$		20	5	ns
Reset Pulse Width	$t_{RS}$		40	30	ns
<b>AC CHARACTERISTICS</b>					
Output Slew Rate	SR	Data = 0x000 to 0x3FF to 0x000	0.05	0.05	V/ $\mu\text{s}$ typ
Settling Time <sup>6</sup>	$t_s$	To $\pm 0.1\%$ of full scale	70	60	$\mu\text{s}$ typ
Shutdown Recovery Time	$t_{SDR}$			80	$\mu\text{s}$ typ
DAC Glitch		Code 0x7FF to Code 0x800 to Code 0x7FF	65	65	nV/s typ
Digital Feedthrough			15	15	nV/s typ
Feedthrough	$V_{OUT}/V_{REF}$	$V_{REF} = 1.5\text{ V dc}$ 11 V p-p, data = 0x000, $f = 100\text{ kHz}$	-63	-63	dB typ
<b>SUPPLY CHARACTERISTICS</b>					
Power Supply Range	$V_{DD\text{ RANGE}}$	DNL $< \pm 1\text{ LSB}$	2.7/5.5	2.7/5.5	V min/max
Positive Supply Current	$I_{DD}$	$V_{IL} = 0\text{ V}$ , no load, $T_A = +25^{\circ}\text{C}$	55	55	$\mu\text{A}$ typ
		$V_{IL} = 0\text{ V}$ , no load	100	100	$\mu\text{A}$ max
Shutdown Supply Current	$I_{DD-SD}$	$\overline{\text{SHDN}} = 0$ , $V_{IL} = 0\text{ V}$ , no load	0.1/1.5	0.1/1.5	$\mu\text{A}$ typ/max
Power Dissipation	$P_{DISS}$	$V_{IL} = 0\text{ V}$ , no load	300	500	$\mu\text{W}$ max
Power Supply Sensitivity	PSS	$\Delta V_{DD} = \pm 5\%$	0.006	0.006	%/% max

<sup>1</sup> One LSB =  $V_{REF}/1024\text{ V}$  for the 10-bit AD7393.

<sup>2</sup> The first two codes (0x000, 0x001) are excluded from the linearity error measurement.

<sup>3</sup> These parameters are guaranteed by design and not subject to production testing.

<sup>4</sup> Typicals represent average readings measured at  $+25^{\circ}\text{C}$ .

<sup>5</sup> All input control signals are specified with  $t_r = t_f = 2\text{ ns}$  (10% to 90% of 13 V) and timed from a voltage level of 1.6 V.

<sup>6</sup> The settling time specification does not apply for negative going transitions within the last 3 LSBs of ground.



## ABSOLUTE MAXIMUM RATINGS

Table 3.

Parameter	Rating
V <sub>DD</sub> to GND	−0.3 V, +8 V
V <sub>REF</sub> to GND	−0.3 V, V <sub>DD</sub>
Logic Inputs to GND	−0.3 V, V <sub>DD</sub> + 0.3 V
V <sub>OUT</sub> to GND	−0.3 V, V <sub>DD</sub> + 0.3 V
I <sub>OUT</sub> Short Circuit to GND	50 mA
DGND to AGND	−0.3 V, +2 V
Package Power Dissipation	(T <sub>J</sub> max − T <sub>A</sub> )/θ <sub>JA</sub>
Thermal Resistance (θ <sub>JA</sub> )	
20-Lead PDIP (N 20)	57°C/W
20-Lead SOIC (R-20)	60°C/W
Maximum Junction Temperature (T <sub>J</sub> max)	150°C
Operating Temperature Range	−40°C to +85°C
AD7393AR	−40°C to +125°C
Storage Temperature Range	−65°C to +150°C
Lead Temperature	
Reflow Soldering Peak Temperature	
SnPb	240°C
Pb-Free	260°C

Stresses above those listed under Absolute Maximum Ratings may cause permanent damage to the device. This is a stress rating only; functional operation of the device at these or any other conditions above those indicated in the operational section of this specification is not implied. Exposure to absolute maximum rating conditions for extended periods may affect device reliability.

### ESD CAUTION



**ESD (electrostatic discharge) sensitive device.** Charged devices and circuit boards can discharge without detection. Although this product features patented or proprietary protection circuitry, damage may occur on devices subjected to high energy ESD. Therefore, proper ESD precautions should be taken to avoid performance degradation or loss of functionality.

## PIN CONFIGURATIONS AND FUNCTION DESCRIPTIONS

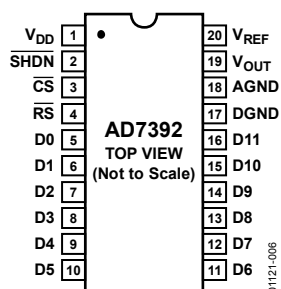

Figure 3. AD7392 Pin Configuration

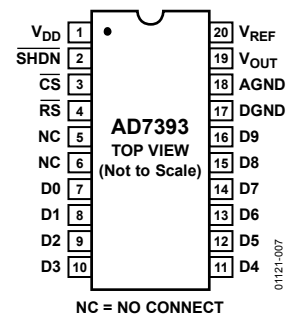

Figure 4. AD7393 Pin Configuration

Table 4. AD7392 Pin Function Descriptions

Pin No.	Mnemonic	Description
1	$V_{DD}$	Positive Power Supply Input. The specified range of operation is 2.7 V to 5.5 V.
2	$\overline{SHDN}$	Power Shutdown Active Low Input. DAC register contents are saved as long as power stays on the $V_{DD}$ pin. When $SHDN = 0$ , $\overline{CS}$ strobes write new data into the DAC register.
3	$\overline{CS}$	Chip Select Latch Enable, Active Low.
4	$\overline{RS}$	Asynchronous Active Low Input. Resets the DAC register to 0.
5 to 16	D0 to D11	Parallel Input Data Bits. D11 is the MSB; D0 is the LSB.
17	DGND	Digital Ground.
18	AGND	Analog Ground.
19	$V_{OUT}$	DAC Voltage Output.
20	$V_{REF}$	DAC Reference Input. Establishes the DAC full-scale voltage.

Table 5. AD7393 Pin Function Descriptions

Pin No.	Mnemonic	Description
1	$V_{DD}$	Positive Power Supply Input. The specified range of operation is 2.7 V to 5.5 V.
2	$\overline{SHDN}$	Power Shutdown Active Low Input. DAC register contents are saved as long as power stays on the $V_{DD}$ pin. When $SHDN = 0$ , $\overline{CS}$ strobes write new data into the DAC register.
3	$\overline{CS}$	Chip Select Latch Enable, Active Low.
4	$\overline{RS}$	Asynchronous Active Low Input. Resets the DAC register to 0.
5, 6	NC	No Connect.
7 to 16	D0 to D9	Parallel Input Data Bits. D9 is the MSB; D0 is the LSB.
17	DGND	Digital Ground.
18	AGND	Analog Ground.
19	$V_{OUT}$	DAC Voltage Output.
20	$V_{REF}$	DAC Reference Input. Establishes the DAC full-scale voltage.

## TYPICAL PERFORMANCE CHARACTERISTICS

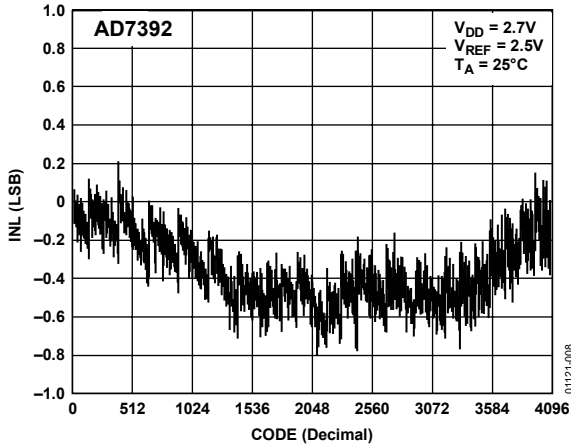

Figure 5. AD7392 Integral Nonlinearity Error vs. Code

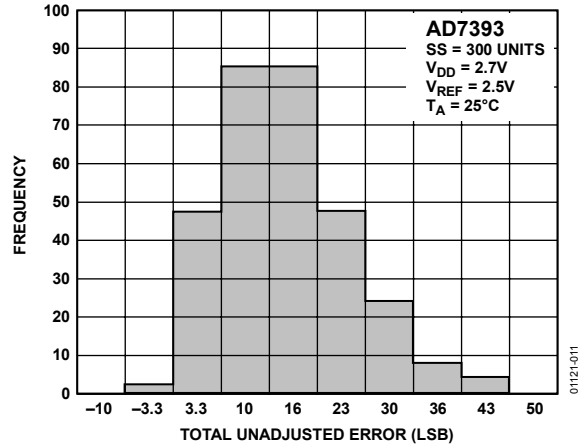

Figure 8. AD7393 Total Unadjusted Error Histogram

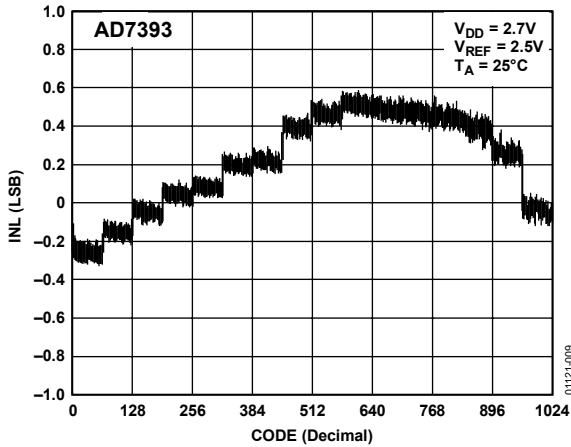

Figure 6. AD7393 Integral Nonlinearity Error vs. Code

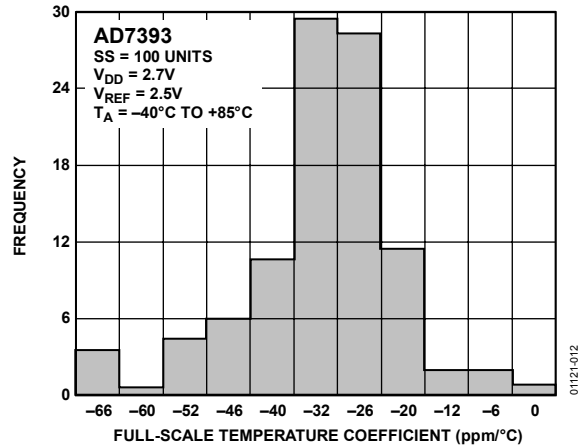

Figure 9. AD7393 Full-Scale Output Temperature Coefficient Histogram

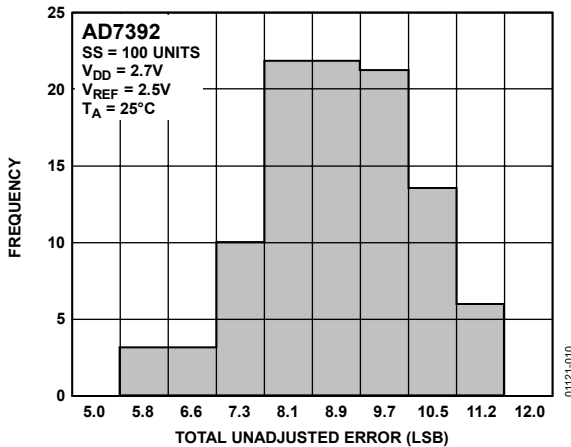

Figure 7. AD7392 Total Unadjusted Error Histogram

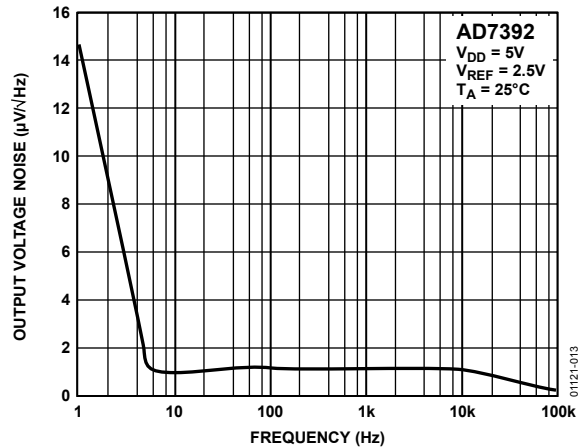

Figure 10. Voltage Noise Density vs. Frequency



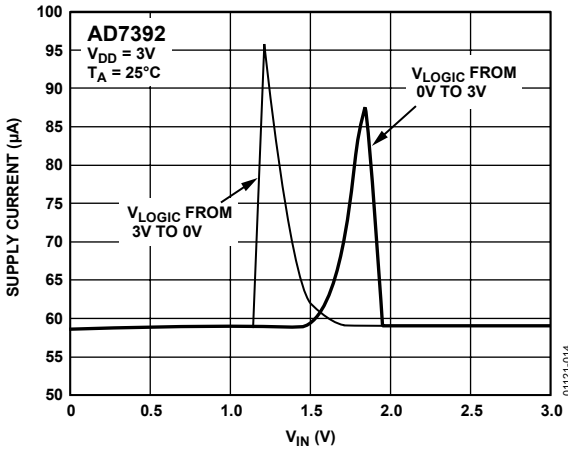

Figure 11. Supply Current vs. Logic Input Voltage

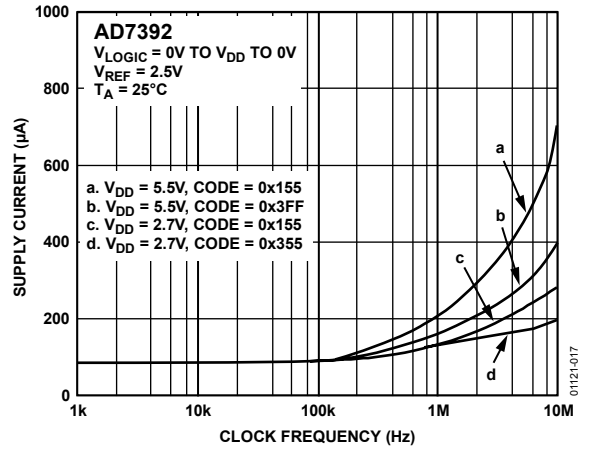

Figure 14. Supply Current vs. Clock Frequency

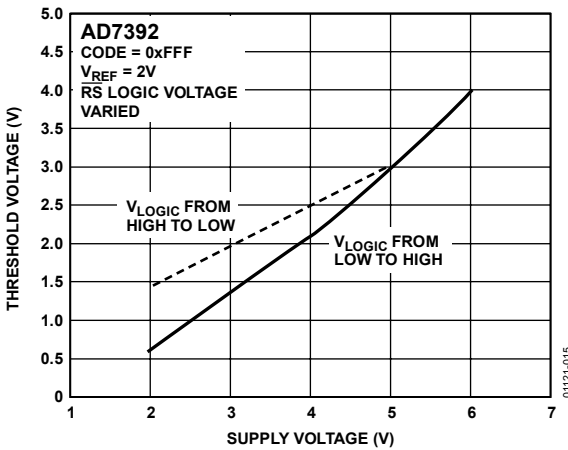

Figure 12. Logic Threshold vs. Supply Voltage

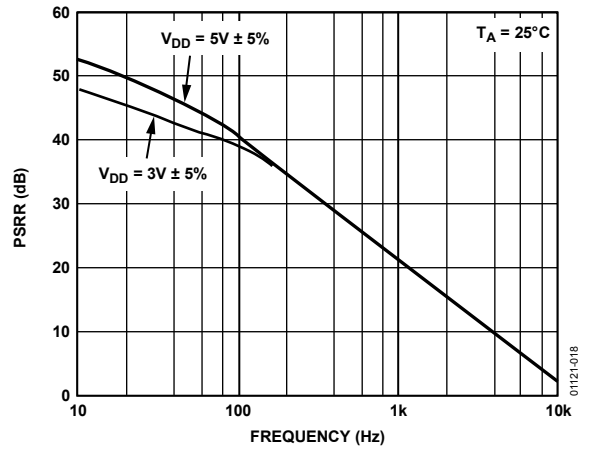

Figure 15. Power Supply Rejection Ratio vs. Frequency

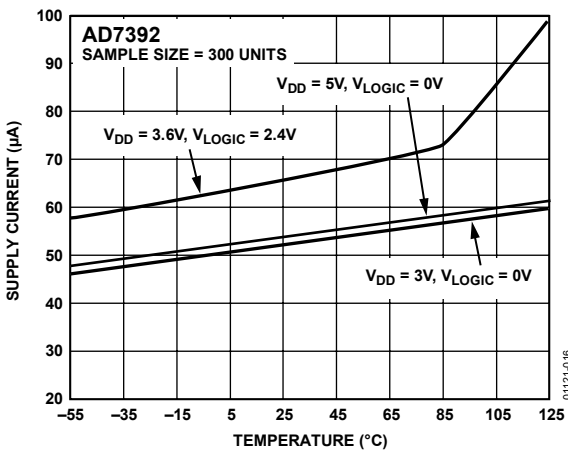

Figure 13. Supply Current vs. Temperature

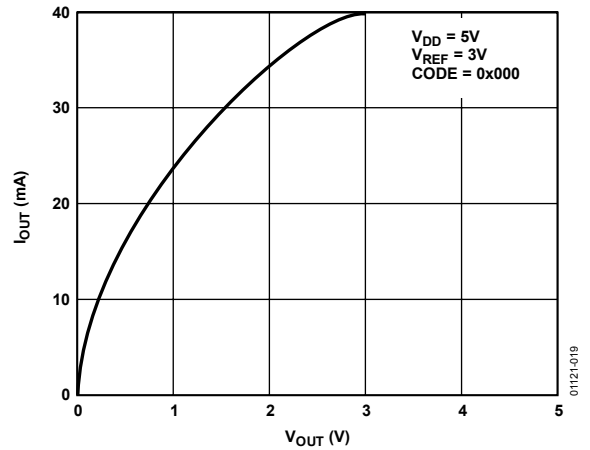

Figure 16.  $I_{OUT}$  at Zero Scale vs.  $V_{OUT}$

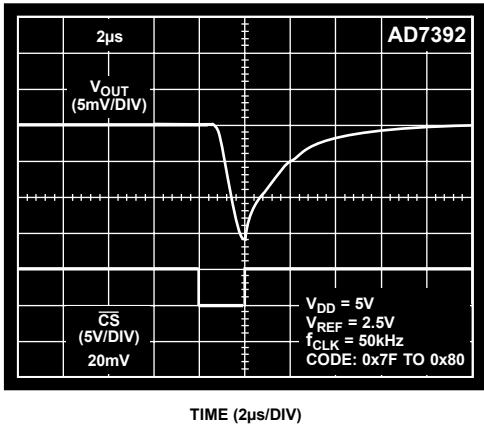

Figure 17. Midscale Transition Performance

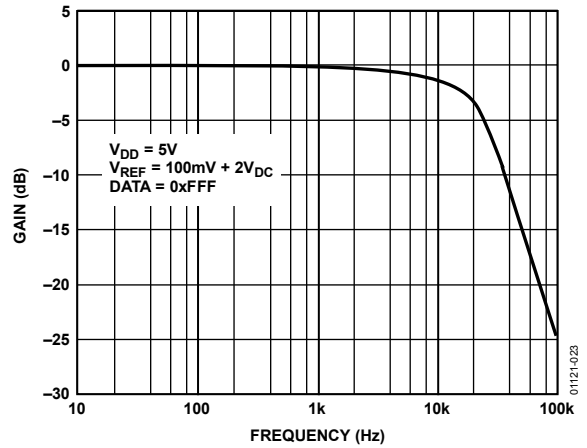

Figure 20. Reference Multiplying Bandwidth

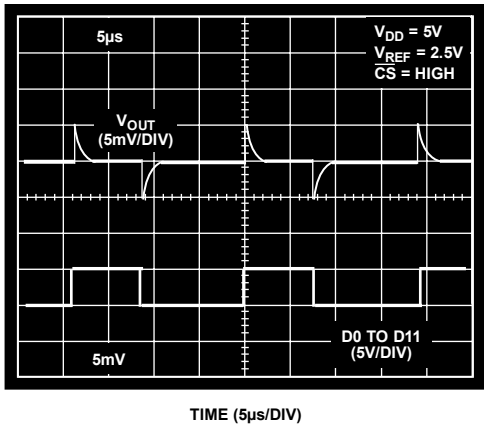

Figure 18. Digital Feedthrough

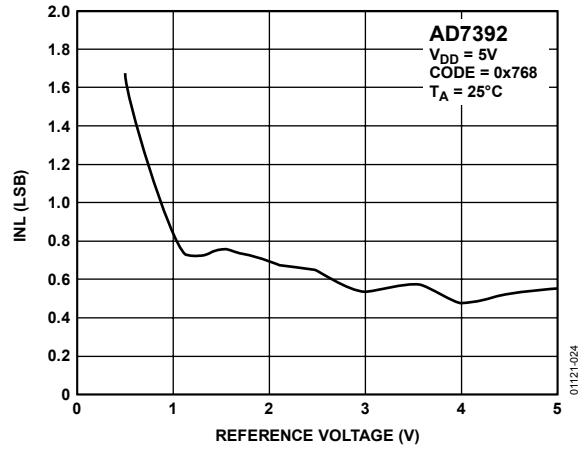

Figure 21. Integral Nonlinearity Error vs. Reference Voltage

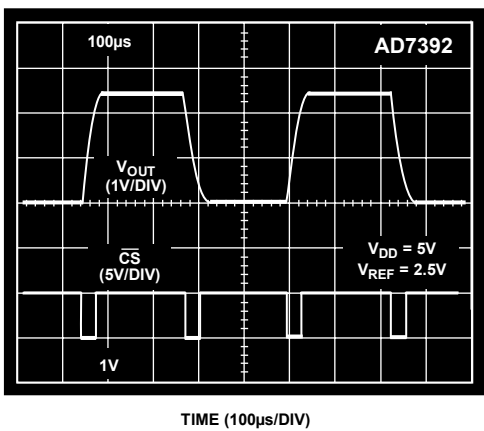

Figure 19. Large Signal Settling Time

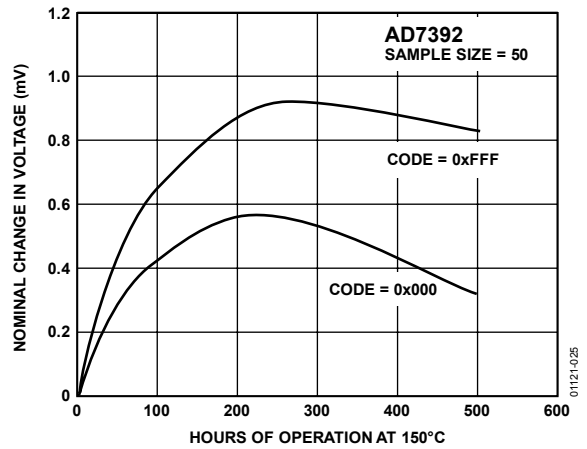

Figure 22. Long-Term Drift Accelerated by Burn-In

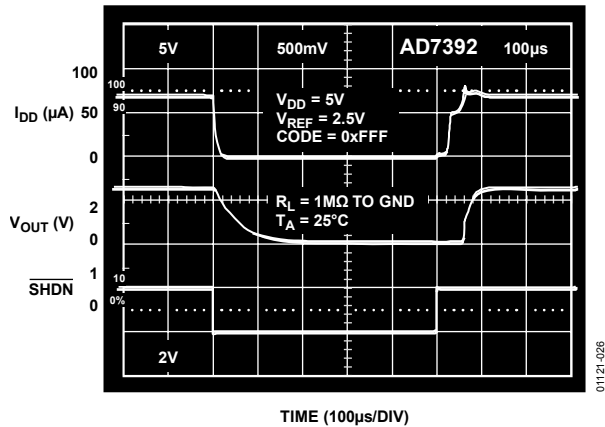

Figure 23. Shutdown Recovery Time

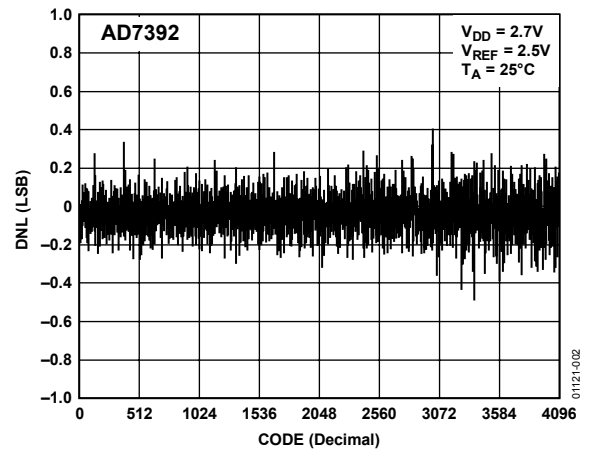

Figure 25. AD7392 Differential Nonlinearity Error vs. Code

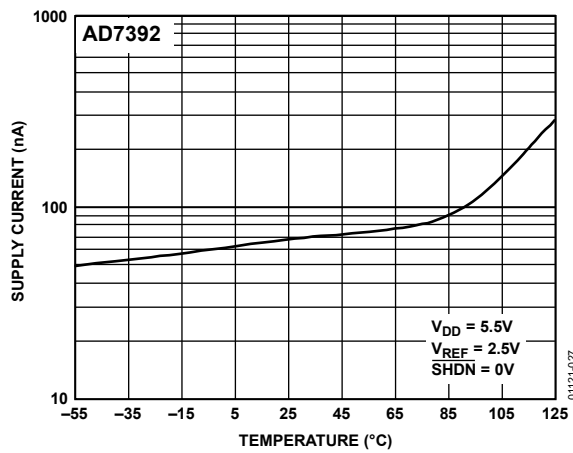

Figure 24. Shutdown Current vs. Temperature

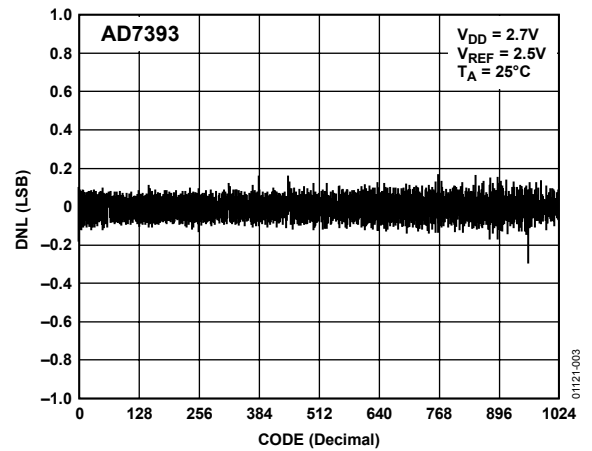

Figure 26. AD7393 Differential Nonlinearity Error vs. Code

## THEORY OF OPERATION

The AD7392/AD7393 comprise a set of pin-compatible, 12-/10-bit digital-to-analog converters (DACs). These single-supply operation devices consume less than 100  $\mu\text{A}$  of current while operating from 2.7 V to 5.5 V power supplies, making them ideal for battery-operated applications. They contain a voltage-switched, 12-/10-bit, laser-trimmed DAC; rail-to-rail output op amps; and a parallel input DAC register. The external reference input has constant input resistance independent of the digital code setting of the DAC. In addition, the reference input can be tied to the same supply voltage as  $V_{\text{DD}}$ , resulting in a maximum output voltage span of 0 V to  $V_{\text{DD}}$ . The parallel data interface consists of a CS write strobe and 12 data bits (D0 to D11) if utilizing the AD7392 or 10 data bits (D0 to D9) if utilizing the AD7393. An RS pin is available to reset the DAC register to zero scale. This function is useful for power-on reset or system failure recovery to a known state. Additional power savings are accomplished by activating the SHDN pin, resulting in a 1.5  $\mu\text{A}$  maximum consumption sleep mode. While the supply voltage is on, data is retained in the DAC register to reset the DAC output when the part is taken out of shutdown (SHDN = 1).

### DIGITAL-TO-ANALOG CONVERTERS

The voltage switched R-2R DAC generates an output voltage that depends on the external reference voltage connected to the  $V_{\text{REF}}$  pin according to Equation 1.

$$V_{\text{OUT}} = V_{\text{REF}} \times \frac{D}{2^N} \quad (1)$$

where:

$D$  is the decimal data-word loaded into the DAC register.  
 $N$  is the number of bits of DAC resolution.

If the 10-bit AD7393 uses a 2.5 V reference, Equation 1 becomes

$$V_{\text{OUT}} = 2.5 \times \frac{D}{1024} \quad (2)$$

Using Equation 2, the nominal midscale voltage at  $V_{\text{OUT}}$  is 1.25 V, for  $D = 512$ ; full-scale voltage is 2.497 V. The LSB step size is  $2.5 \times 1/1024 = 0.0024$  V.

If the 12-bit AD7392 uses a 5.0 V reference, Equation 1 becomes

$$V_{\text{OUT}} = V_{\text{REF}} \times \frac{D}{4096} \quad (3)$$

Using Equation 3, the AD7392 provides a nominal midscale voltage of 2.50 V (for  $D = 2048$ ) and a full-scale  $V_{\text{OUT}}$  of 4.998 V. The LSB step size is  $5.0 \times 1/4096 = 0.0012$  V.

### AMPLIFIER SECTION

The internal DACs output is buffered by a low power consumption precision amplifier. The op amp has a 60  $\mu\text{s}$  typical settling time to 0.1% of full scale. There are slight differences in settling time for negative slew signals vs. positive. Also, negative transition settling time to within the last 6 LSBs of 0 V has an extended settling time. The rail-to-rail output stage of this amplifier has been designed to provide precision performance while operating near either power supply. Figure 27 shows an equivalent output schematic of the rail-to-rail amplifier with its N-channel pull-down FETs that pull an output load directly to GND. The output sourcing current is provided by a P-channel, pull-up device that can source current-to-GND terminated loads.

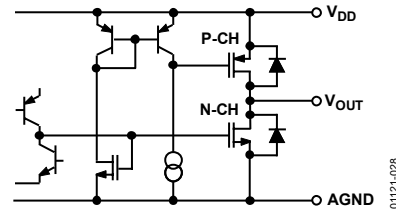

Figure 27. Equivalent Analog Output Circuit

The rail-to-rail output stage provides  $\pm 1$  mA of output current. The N-channel output pull-down MOSFET, shown in Figure 27, has a 35  $\Omega$  on resistance that sets the sink current capability near ground. In addition to resistive load driving capability, the amplifier also has been carefully designed and characterized for up to 100 pF capacitive load driving capability.

### REFERENCE INPUT

The reference input terminal has a constant input resistance independent of digital code, which results in reduced glitches on the external reference voltage source. The high 2.5 M $\Omega$  input resistance minimizes power dissipation within the AD7392/AD7393 DACs. The  $V_{\text{REF}}$  input accepts input voltages ranging from ground to the positive supply voltage  $V_{\text{DD}}$ . One of the simplest applications for saving an external reference voltage source is connecting the REF terminal to the positive  $V_{\text{DD}}$  supply. This connection results in a rail-to-rail voltage output span maximizing the programmed range. The reference input accepts ac signals as long as they stay within the  $0 \text{ V} < V_{\text{REF}} < V_{\text{DD}}$  supply voltage range. The reference bandwidth and integral nonlinearity error performance are plotted in Figure 20 and Figure 21. The ratiometric reference feature makes the AD7392/AD7393 an ideal companion to ratiometric analog-to-digital converters (ADCs) such as the AD7896.

**POWER SUPPLY**

The very low power consumption of the AD7392/AD7393 is a direct result of a circuit design that optimizes the CBCMOS process. By using the low power characteristics of CMOS for the logic and the low noise, tight-matching of the complementary bipolar transistors, excellent analog accuracy is achieved. One advantage of the rail-to-rail output amplifiers used in the AD7392/AD7393 is the wide range of usable supply voltage. The part is fully specified and tested for operation from 2.7 V to 5.5 V.

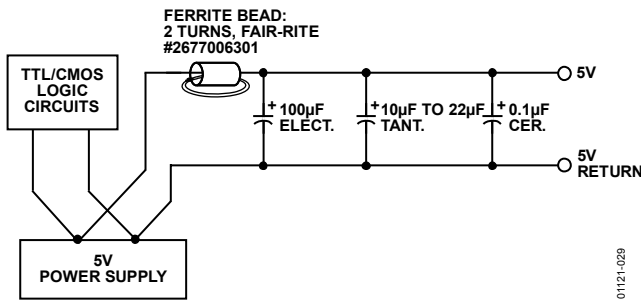

Figure 28. Use Separate Traces to Reduce Power Supply Noise

Whether or not a separate power supply trace is available, generous supply bypassing reduces supply line induced errors. Local supply bypassing, consisting of a 10 µF tantalum electrolytic in parallel with a 0.1 µF ceramic capacitor, is recommended for all applications (see Figure 29).

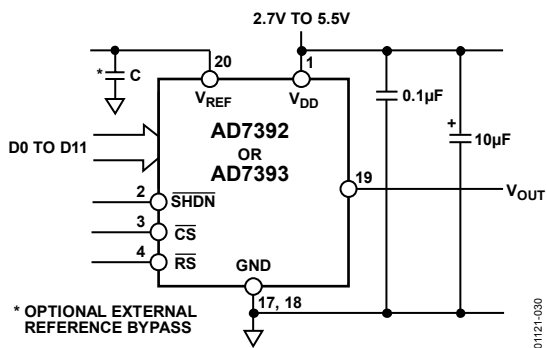

Figure 29. Recommended Supply Bypassing for the AD7392/AD7393

**INPUT LOGIC LEVELS**

All digital inputs are protected with a Zener-type ESD protection structure that allows logic input voltages to exceed the V<sub>DD</sub> supply voltage (see Figure 30). This feature is useful if the user is driving one or more of the digital inputs with a 5 V CMOS logic input voltage level while operating the AD7392/AD7393 on a 3 V power supply. If this interface is used, make sure that the V<sub>OL</sub> of the 5 V CMOS meets the V<sub>IL</sub> input requirement of the AD7392/AD7393 operating at 3 V. See Figure 12 for a graph of digital logic input threshold vs. operating V<sub>DD</sub> supply voltage.

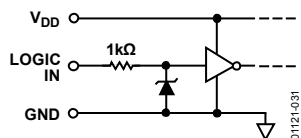

Figure 30. Equivalent Digital Input ESD Protection

To minimize power dissipation from input logic levels that are near the V<sub>IH</sub> and V<sub>IL</sub> logic input voltage specifications, a Schmitt-trigger design was used that minimizes the input buffer current consumption compared to traditional CMOS input stages. Figure 11 is a plot of supply current vs. incremental input voltage, showing that negligible current consumption takes place when logic levels are in their quiescent state. The normal crossover current still occurs during logic transitions. A secondary advantage of this Schmitt trigger is the prevention of false triggers that would occur with slow moving logic transitions when a standard CMOS logic interface or opto-isolators are used. Logic inputs D11 to D0, CS, RS, and SHDN all contain the Schmitt-trigger circuits.

**DIGITAL INTERFACE**

The AD7392/AD7393 have a parallel data input. A functional block diagram of the digital section is shown in Figure 31, while Table 6 contains the truth table for the logic control inputs. The chip select pin ( $\overline{CS}$ ) controls loading of data from the data inputs on Pin D11 to Pin D0. This active low input places the input register into a transparent state allowing the data inputs to directly change the DAC ladder values. When  $\overline{CS}$  returns to logic high within the data setup-and-hold time specifications, the new value of data in the input register are latched. See Table 6 for a complete listing of conditions.

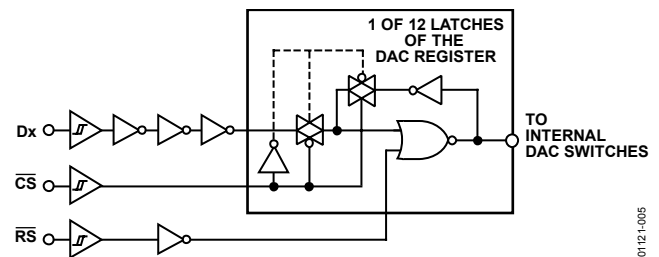

Figure 31. Digital Control Logic

Table 6. Control Logic Truth Table

$\overline{CS}$	$\overline{RS}$	DAC Register Function
H	H	Latched
L	H	Transparent
$\uparrow^1$	H	Latched with new data
X <sup>2</sup>	L	Loaded with all zeros
H	$\uparrow^1$	Latched all zeros

<sup>1</sup>  $\uparrow$  = Positive logic transition.

<sup>2</sup> X = Don't care.

# AD7392/AD7393

## RESET PIN ( $\overline{RS}$ )

Forcing the asynchronous  $\overline{RS}$  pin low sets the DAC register to all 0s, so the DAC output voltage is 0 V. The reset function is useful for setting the DAC outputs to 0 at power-up or after a power supply interruption. Test systems and motor controllers are two of many applications that benefit from powering up to a known state. The external reset pulse can be generated by three methods:

- The microprocessor's power-on RESET signal
- An output from the microprocessor
- An external resistor and capacitor

RESET has a Schmitt-trigger input, which results in a clean reset function when using external resistor-/capacitor-generated pulses (see Table 6).

## POWER SHUTDOWN ( $\overline{SHDN}$ )

Maximum power savings can be achieved by using the power shutdown control function. This hardware-activated feature is controlled by the active low input  $\overline{SHDN}$  pin. This pin has a Schmitt-trigger input that helps desensitize it to slowly changing inputs. Setting this pin to logic low reduces the internal consumption of the AD7392/AD7393 to nanoamp levels, guaranteed to 1.5  $\mu$ A maximum over the operating temperature range. If power is present at all times on the  $V_{DD}$  pin while in shutdown mode, the internal DAC register retains the last programmed data value. The digital interface is still active in shutdown so that code changes can be made that produce new DAC settings when the device is taken out of shutdown. This data is used when the part is returned to the normal active state by placing the DAC back to its programmed voltage setting. Figure 23 shows a plot of shutdown recovery time with both  $I_{DD}$  and  $V_{OUT}$  displayed. In the shutdown state, the DAC output amplifier exhibits an open-circuit high resistance state. Any load that is connected stabilizes at its termination voltage. If the power shutdown feature is not needed, the user should tie the  $\overline{SHDN}$  pin to the  $V_{DD}$  voltage to disable this function.

## UNIPOLAR OUTPUT OPERATION

This is the basic mode of operation for the AD7392. The AD7392 is designed to drive loads as low as 5 k $\Omega$  in parallel with 100 pF (see Figure 32). The code table for this operation is shown in Table 7.

The circuit can be configured with an external reference plus power supply or powered from a single dedicated regulator or reference depending on the application performance requirements.

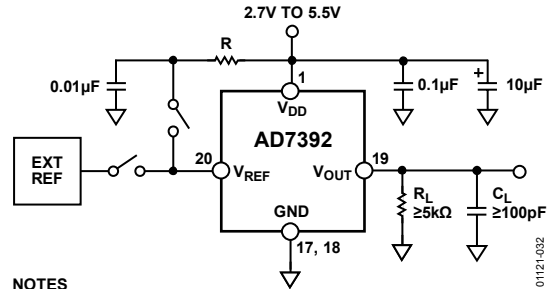

NOTES  
1. DIGITAL INTERFACE CIRCUITRY OMITTED FOR CLARITY  
Figure 32. AD7392 Unipolar Output Operation

Table 7. Unipolar Code Table

DAC Register No.		Output Voltage (V), $V_{REF} = 2.5$ V
Hexadecimal	Decimal	
0xFFF	4095	2.4994
0x801	2049	1.2506
0x800	2048	1.2500
0x7FF	2047	1.2494
0x000	0	0

## BIPOLAR OUTPUT OPERATION

Although the AD7393 is designed for single-supply operation, the output can be easily configured for bipolar operation. A typical circuit is shown in Figure 33. This circuit uses a clean, regulated 5 V supply for power, which also provides the circuit's reference voltage. Since the AD7393 output span swings from ground to very near 5 V, it is necessary to choose an external amplifier with a common-mode input voltage range that extends to its positive supply rail. The micropower consumption OP196 is designed just for this purpose and results in only 50  $\mu\text{A}$  of maximum current consumption. Connecting the two 470 k $\Omega$  resistors results in a differential amplifier mode of operation with a voltage gain of 2, which produces a circuit output span of 10 V, that is,  $-5\text{ V}$  to  $+5\text{ V}$ . As the DAC is programmed from zero-code 0x000 to midscale 0x200 to full scale 0x3FF, the circuit output voltage,  $V_o$ , is set at  $-5\text{ V}$ ,  $0\text{ V}$ , and  $+5\text{ V}$  (minus 1 LSB). The output voltage,  $V_o$ , is coded in offset binary according to Equation 4.

$$V_o = \left[ \frac{D}{512} - 1 \right] \times 5 \quad (4)$$

where  $D$  is the decimal code loaded in the AD7393 DAC register.

Note that the LSB step size is  $10/1024 = 10\text{ mV}$ . This circuit is optimized for micropower consumption including the 470 k $\Omega$  gain setting resistors, which should have low temperature coefficients to maintain accuracy and matching (preferably the same resistor material, such as metal film).

If better stability is required, the power supply may be substituted with a precision reference voltage such as the low dropout REF195, which can easily supply the circuit's 162  $\mu\text{A}$  of current, and still provide additional power for the load connected to  $V_o$ . The micropower REF195 is guaranteed to source 10 mA output drive current, but consumes only 50  $\mu\text{A}$  internally.

If higher resolution is required, the AD7392 can be used with two additional bits of data inserted into the software coding, which results in a 2.5 mV LSB step size. Table 8 shows examples of nominal output voltages ( $V_o$ ) provided by the bipolar operation circuit application.

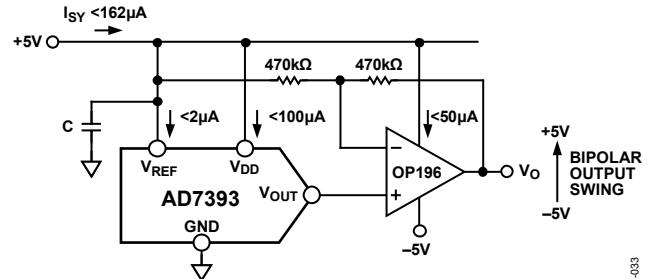

NOTES  
1. DIGITAL INTERFACE CIRCUITRY OMITTED FOR CLARITY

Figure 33. Bipolar Output Operation

Table 8. Bipolar Code Table

DAC Register No.		Analog Output Voltage (V)
Hexadecimal	Decimal	
0x3FF	1023	+4.9902
0x201	513	+0.0097
0x200	512	0.0000
0x1FF	511	-0.0097
0x000	0	-5.0000

OUTLINE DIMENSIONS

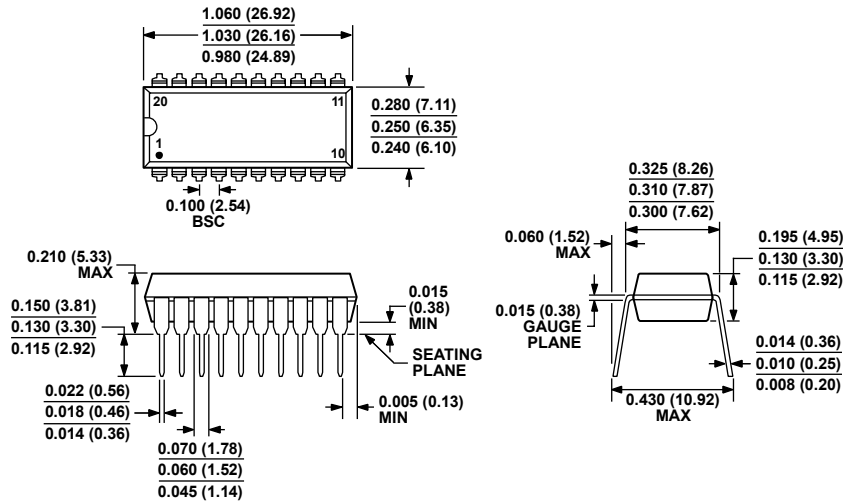

COMPLIANT TO JEDEC STANDARDS MS-001

CONTROLLING DIMENSIONS ARE IN INCHES; MILLIMETER DIMENSIONS (IN PARENTHESES) ARE ROUNDED-OFF INCH EQUIVALENTS FOR REFERENCE ONLY AND ARE NOT APPROPRIATE FOR USE IN DESIGN. CORNER LEADS MAY BE CONFIGURED AS WHOLE OR HALF LEADS.

Figure 34. 20-Lead Plastic Dual In-Line Package [PDIP] Narrow Body (N-20)

Dimensions shown in inches and (millimeters)

070706-A

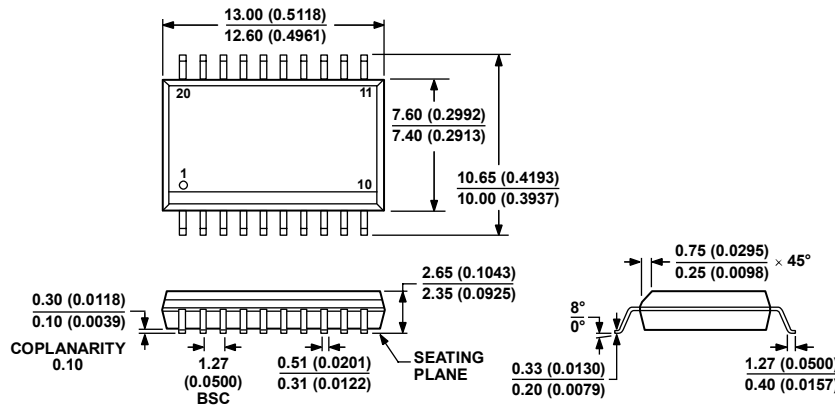

COMPLIANT TO JEDEC STANDARDS MS-013-AC

CONTROLLING DIMENSIONS ARE IN MILLIMETERS; INCH DIMENSIONS (IN PARENTHESES) ARE ROUNDED-OFF MILLIMETER EQUIVALENTS FOR REFERENCE ONLY AND ARE NOT APPROPRIATE FOR USE IN DESIGN.

Figure 35. 20-Lead Standard Small Outline Package [SOIC\_W] Wide Body (RW-20)

Dimensions shown in millimeters and (inches)

060706-A



**ORDERING GUIDE**

<b>Model</b>	<b>Resolution (Bits)</b>	<b>Temperature Range</b>	<b>Package Description</b>	<b>Package Option</b>
AD7392AN	12	−40°C to +85°C	20-Lead PDIP	N-20
AD7392ANZ <sup>1</sup>	12	−40°C to +85°C	20-Lead PDIP	N-20
AD7392AR	12	−40°C to +85°C	20-Lead SOIC_W	RW-20
AD7392AR-REEL	12	−40°C to +85°C	20-Lead SOIC_W	RW-20
AD7392ARZ <sup>1</sup>	12	−40°C to +85°C	20-Lead SOIC_W	RW-20
AD7392ARZ-REEL <sup>1</sup>	12	−40°C to +85°C	20-Lead SOIC_W	RW-20
AD7393AN	10	−40°C to +85°C	20-Lead PDIP	N-20
AD7393AR	10	−40°C to +125°C	20-Lead SOIC_W	RW-20
AD7393ARZ <sup>1</sup>	10	−40°C to +125°C	20-Lead SOIC_W	RW-20

<sup>1</sup> Z = RoHS Compliant Part.

**AD7392/AD7393**

**NOTES**

**NOTES**

**AD7392/AD7393**

**NOTES**