

### FEATURES

- RF frequency: 700 MHz to 2800 MHz continuous
- LO frequency: 250 MHz to 2800 MHz, high-side or low-side inject
- IF range: 30 MHz to 450 MHz
- Power conversion gain of 6.7 dB at 1900 MHz
- SSB noise figure of 11.6 dB at 1900 MHz
- Input IP3 of 27.2 dBm at 1900 MHz
- Input P1dB of 12.5 dBm at 1900 MHz
- Typical LO drive of 0 dBm
- Single-ended, 50 Ω RF port
- Single-ended or balanced LO input port
- Single-supply operation: 3.6 V to 5.0 V
- Serial port interface control on all functions
- Exposed paddle 6 mm × 6 mm, 40-lead LFCSP package

### APPLICATIONS

- Multiband/multistandard cellular base station diversity receivers
- Wideband radio link diversity downconverters
- Multimode cellular extenders and broadband receivers

### GENERAL DESCRIPTION

The ADL5812 uses revolutionary new broadband, square wave limiting, local oscillator (LO) amplifiers to achieve an unprecedented radio frequency (RF) bandwidth of 700 MHz to 2800 MHz. Unlike conventional narrow-band sine wave LO amplifier solutions, this permits the LO to be applied either above or below the RF input over an extremely wide bandwidth. Because energy storage elements are not used, the dc current consumption also decreases with decreasing LO frequency.

The ADL5812 uses highly linear, doubly balanced, passive mixer cores along with integrated RF and LO balancing circuits to allow single-ended operation. The ADL5812 incorporates programmable RF baluns, allowing optimal performance over a 700 MHz to 2800 MHz RF input frequency. The balanced passive mixer arrangement provides outstanding LO-to-RF and LO-to-IF leakages, excellent RF-to-IF isolation, and excellent intermodulation performance over the full RF bandwidth.

The balanced mixer cores also provide extremely high input linearity, allowing the device to be used in demanding

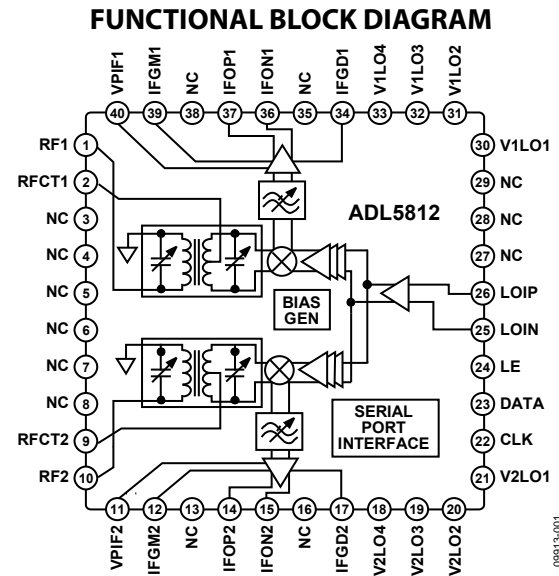

Figure 1.

wideband applications where in-band blocking signals may otherwise result in the degradation of dynamic range. Blocker noise figure performance is comparable to narrow-band passive mixer designs. High linearity IF buffer amplifiers follow the passive mixer cores, yielding typical power conversion gains of 6.7 dB, and can be used with a wide range of output impedances. For low voltage applications, the ADL5812 is capable of operation at voltages down to 3.6 V with substantially reduced current. Two logic bits are provided to individually power down (1.5 mA for both channels) the two channels as desired.

All features of the ADL5812 are controlled via a 3-wire serial port interface, resulting in optimum performance and minimum external components.

The ADL5812 is fabricated using a BiCMOS high performance IC process. The device is available in a 40-lead, 6mm × 6mm, LFCSP package and operates over a -40°C to +85°C temperature range. An evaluation board is also available.

### Rev. 0

Information furnished by Analog Devices is believed to be accurate and reliable. However, no responsibility is assumed by Analog Devices for its use, nor for any infringements of patents or other rights of third parties that may result from its use. Specifications subject to change without notice. No license is granted by implication or otherwise under any patent or patent rights of Analog Devices. Trademarks and registered trademarks are the property of their respective owners.

# ADL5812\* Product Page Quick Links

Last Content Update: 08/30/2016

---

## [Comparable Parts](#)

View a parametric search of comparable parts

## [Evaluation Kits](#)

- ADL5812 Evaluation Board

## [Documentation](#)

### **Data Sheet**

- ADL5812: Dual High IP3, 700 MHz to 2800 MHz, Double Balanced, Passive Mixer, IF Amplifier, and Wideband LO Amplifier Data Sheet

## [Software and Systems Requirements](#)

- ADL5811 and ADL5812 Evaluation Board Software

## [Tools and Simulations](#)

- ADIsimPLL™
- ADIsimRF

## [Reference Materials](#)

### **Product Selection Guide**

- RF Source Booklet

## [Design Resources](#)

- ADL5812 Material Declaration
- PCN-PDN Information
- Quality And Reliability
- Symbols and Footprints

## [Discussions](#)

View all ADL5812 EngineerZone Discussions

## [Sample and Buy](#)

Visit the product page to see pricing options

## [Technical Support](#)

Submit a technical question or find your regional support number

---

# www.BDTIC.com/cn/adi

\* This page was dynamically generated by Analog Devices, Inc. and inserted into this data sheet. Note: Dynamic changes to the content on this page does not constitute a change to the revision number of the product data sheet. This content may be frequently modified.

**TABLE OF CONTENTS**

Features .....	1	RF Subsystem .....	20
Applications .....	1	LO Subsystem .....	21
Functional Block Diagram .....	1	Applications Information .....	22
General Description .....	1	Basic Connections .....	22
Revision History .....	2	IF Port .....	22
Specifications .....	3	Bias Resistor Selection .....	22
Timing Characteristics .....	4	VGS Programming .....	23
Absolute Maximum Ratings .....	5	Low-Pass Filter Programming .....	23
ESD Caution .....	5	RF Balun Programming .....	23
Pin Configuration and Function Descriptions .....	6	Register Structure .....	24
Typical Performance Characteristics .....	7	Evaluation Board .....	25
3.6 V Performance .....	16	Outline Dimensions .....	27
Spurious Performance .....	17	Ordering Guide .....	27
Circuit Description .....	20		

**REVISION HISTORY**

7/11—Revision 0: Initial Version

[www.BDTIC.com/cn/adi](http://www.BDTIC.com/cn/adi)

## SPECIFICATIONS

$V_S = 5\text{ V}$ ,  $T_A = 25^\circ\text{C}$ ,  $f_{RF} = 1900\text{ MHz}$ ,  $f_{LO} = 1697\text{ MHz}$ , RF power =  $-10\text{ dBm}$ , LO power =  $0\text{ dBm}$ ,  $R_1 = R_2 = 1200\ \Omega$ ,  $Z_0 = 50\ \Omega$ , optimum SPI settings, unless otherwise noted.

Table 1.

Parameter	Test Conditions/Comments	Min	Typ	Max	Unit
RF INPUT INTERFACE					
Return Loss	Tunable to $>20\text{ dB}$ broadband via serial port		10		dB
Input Impedance			50		$\Omega$
RF Frequency Range		700		2800	MHz
OUTPUT INTERFACE					
Output Impedance	Differential impedance, $f = 200\text{ MHz}$		260  1.2		$\Omega$   pF
IF Frequency Range		30		450	MHz
DC Bias Voltage <sup>1</sup>	Externally generated		$V_S$		V
LO INTERFACE					
LO Power		$-6$	0	$+10$	dBm
Return Loss			13.3		dB
Input Impedance			50		$\Omega$
LO Frequency Range	Low-side or high-side LO	250		2800	MHz
DYNAMIC PERFORMANCE					
Power Conversion Gain	Including 4:1 IF port transformer and PCB loss		6.7		dB
Voltage Conversion Gain	$Z_{SOURCE} = 50\ \Omega$ , differential $Z_{LOAD} = 200\ \Omega$ differential		13.1		dB
SSB Noise Figure			11.6		dB
SSB Noise Figure Under Blocking	5 dBm blocker present $\pm 10\text{ MHz}$ from wanted RF input, LO source filtered		21		dB
Input Third-Order Intercept	$f_{RF1} = 1900\text{ MHz}$ , $f_{RF2} = 1901\text{ MHz}$ , $f_{LO} = 1697\text{ MHz}$ , each RF tone at $-10\text{ dBm}$		27.2		dBm
Input Second-Order Intercept	$f_{RF1} = 1900\text{ MHz}$ , $f_{RF2} = 2000\text{ MHz}$ , $f_{LO} = 1697\text{ MHz}$ , each RF tone at $-10\text{ dBm}$		55		dBm
Input 1 dB Compression Point			12.5		dBm
LO-to-IF Output Leakage	Unfiltered IF output		$-37$		dBm
LO-to-RF Input Leakage			$-46$		dBm
RF-to-IF Output Isolation			26		dB
IF/2 Spurious	$-10\text{ dBm}$ input power		$-70$		dBc
IF/3 Spurious	$-10\text{ dBm}$ input power		$-78$		dBc
POWER INTERFACE					
Supply Voltage, $V_S$		3.6	5	5.5	V
Quiescent Current	Resistor programmable IF current		412		mA
Power-Down Current			1.5		mA

<sup>1</sup> Supply voltage must be applied from external circuit through choke inductors.

## TIMING CHARACTERISTICS

Low logic level  $\leq 0.4$  V, and high logic level  $\geq 1.4$  V.

Table 2. Serial Interface Timing

Parameter	Limit	Unit	Test Conditions/Comments
$t_1$	20	ns minimum	LE setup time
$t_2$	10	ns minimum	DATA-to-CLK setup time
$t_3$	10	ns minimum	DATA-to-CLK hold time
$t_4$	25	ns minimum	CLK high duration
$t_5$	25	ns minimum	CLK low duration
$t_6$	10	ns minimum	CLK-to-LE setup time
$t_7$	20	ns minimum	LE pulse width

### Timing Diagram

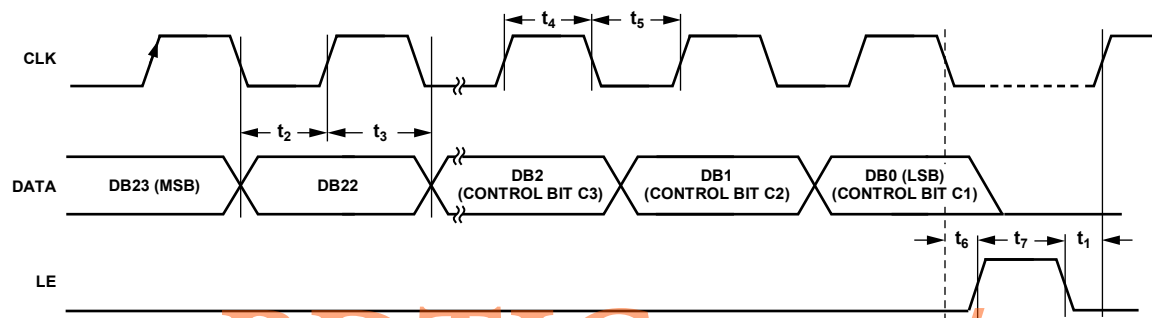

Figure 2. Timing Diagram

09913-002

## ABSOLUTE MAXIMUM RATINGS

Table 3.

Parameter	Rating
Supply Voltage, $V_{POS}$	5.5 V
CLK, DATA, LE	5.5 V
IF Output Bias	6.0 V
RF Input Power	20 dBm
LO Input Power	13 dBm
Internal Power Dissipation	2.5 W
$\theta_{JA}$ (Exposed Paddle Soldered Down)	30°C
Maximum Junction Temperature	150°C
Operating Temperature Range	-40°C to +85°C
Storage Temperature Range	-65°C to +150°C

Stresses above those listed under Absolute Maximum Ratings may cause permanent damage to the device. This is a stress rating only; functional operation of the device at these or any other conditions above those indicated in the operational section of this specification is not implied. Exposure to absolute maximum rating conditions for extended periods may affect device reliability.

### ESD CAUTION



#### ESD (electrostatic discharge) sensitive device.

Charged devices and circuit boards can discharge without detection. Although this product features patented or proprietary protection circuitry, damage may occur on devices subjected to high energy ESD. Therefore, proper ESD precautions should be taken to avoid performance degradation or loss of functionality.

[www.BDTIC.com/cn/adi](http://www.BDTIC.com/cn/adi)

PIN CONFIGURATION AND FUNCTION DESCRIPTIONS

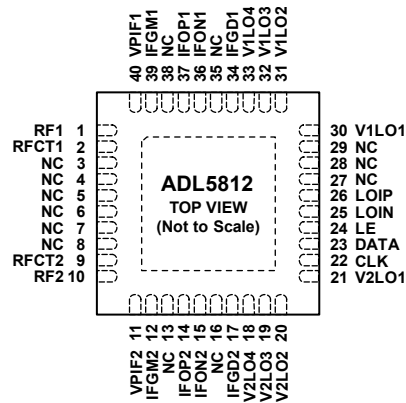

NOTES  
 1. NC = NO CONNECT. CAN BE GROUNDED.  
 2. EXPOSED PAD MUST BE CONNECTED TO GROUND.

08913-003

Figure 3. Pin Configuration

Table 4. Pin Function Descriptions

Pin No.	Mnemonic	Description
1, 10	RF1, RF2	RF Input. Should be ac-coupled.
2, 9	RFCT1, RFCT2	RF Balun Center Tap (AC Ground).
3 to 8, 13, 16, 27 to 29, 35, 38	NC	No Connect. Can be grounded.
11, 40	VPIF1, VPIF2	Supply Voltage for IF Amplifier.
12, 39	IFGM1, IFGM2	IF Amplifier Bias Control.
14, 15, 36, 37	IFOP1, IFOP2, IFON1, IFON2	Differential Open-Collector IF Outputs. Should be pulled up to V <sub>CC</sub> via external inductors.
17, 34	IFGD1, IFGD2	Supply Return for IF Amplifier. Must be grounded.
18 to 21, 30 to 33	V1LO1, V1LO2, V1LO3, V1LO4, V2LO1, V2LO2, V2LO3, V2LO4	Positive Supply Voltages for LO Amplifiers.
22, 23, 24	CLK, DATA, LE	Serial Port Interface Control.
25	LOIN	Ground Return for LO Input. Must be ac coupled.
26	LOIP	LO Input. Should be ac-coupled.
	EPAD	Exposed pad must be connected to ground.

## TYPICAL PERFORMANCE CHARACTERISTICS

$V_S = 5\text{ V}$ ,  $T_A = 25^\circ\text{C}$ ,  $f_{RF} = 1900\text{ MHz}$ ,  $f_{LO} = 1697\text{ MHz}$ , RF power =  $-10\text{ dBm}$ , LO power =  $0\text{ dBm}$ ,  $R_1 = R_2 = 1200\ \Omega$ ,  $Z_O = 50\ \Omega$ , optimum SPI settings, unless otherwise noted.

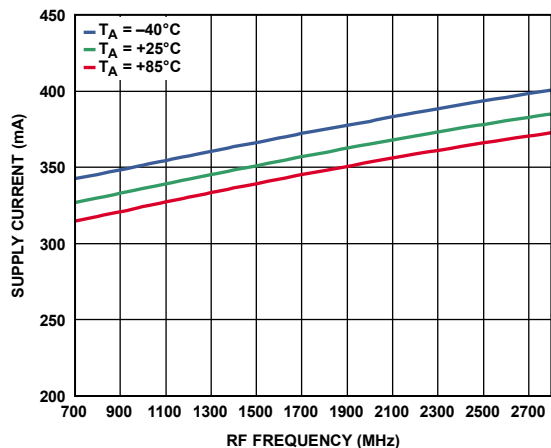

Figure 4. Supply Current vs. RF Frequency

09913-008

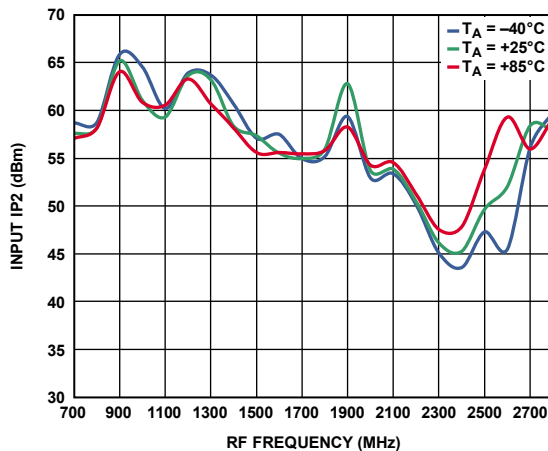

Figure 7. Input IP2 vs. RF Frequency

09913-016

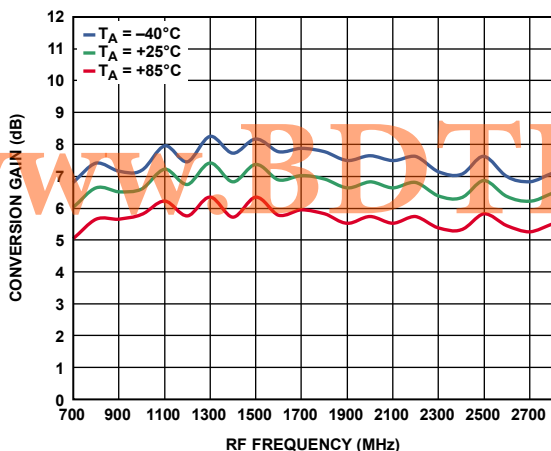

Figure 5. Power Conversion Gain vs. RF Frequency

09913-011

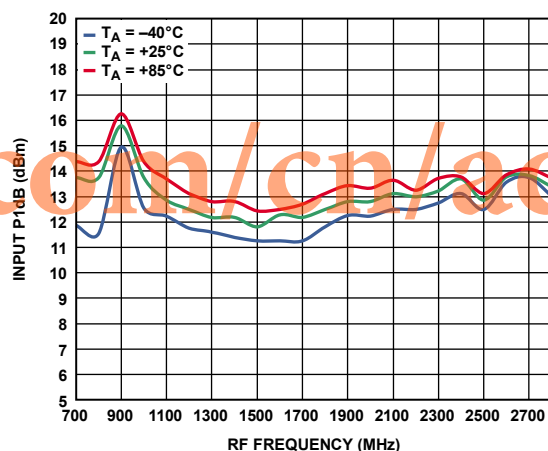

Figure 8. Input P1dB vs. RF Frequency

09913-020

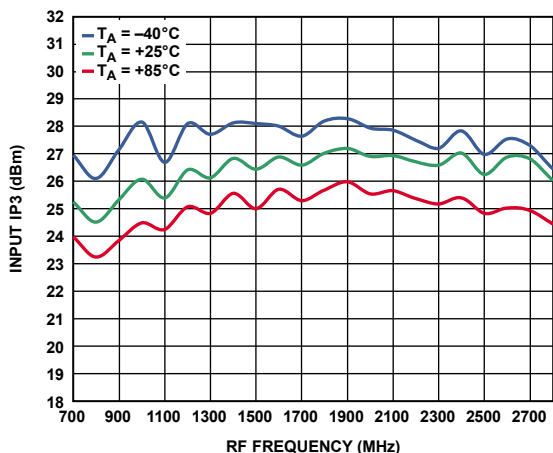

Figure 6. Input IP3 vs. RF Frequency

09913-019

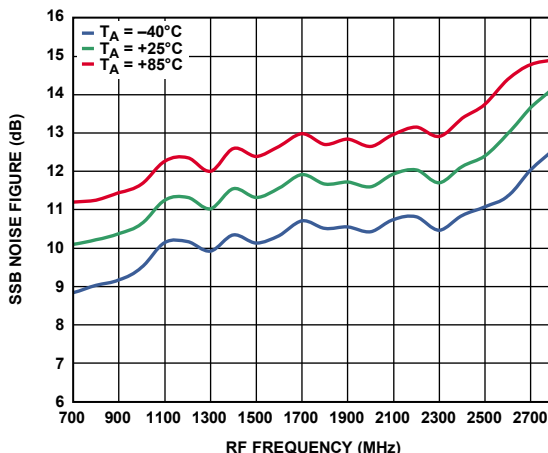

Figure 9. SSB Noise Figure vs. RF Frequency

09913-025



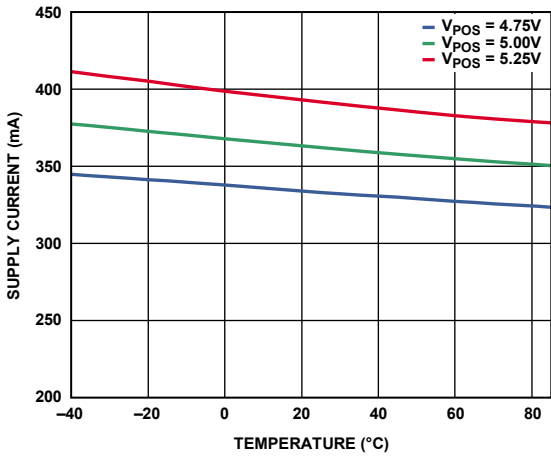

Figure 10. Supply Current vs. Temperature

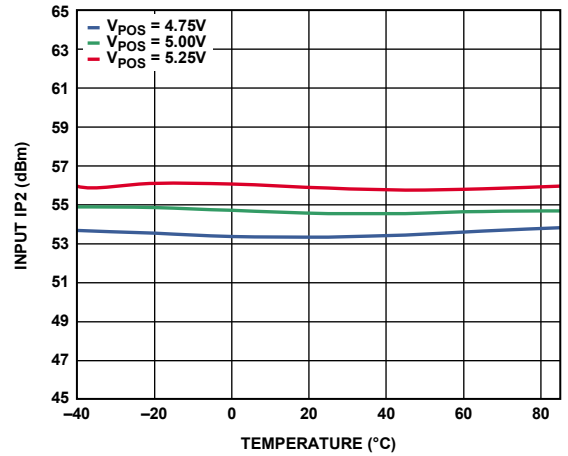

Figure 13. Input IP2 vs. Temperature

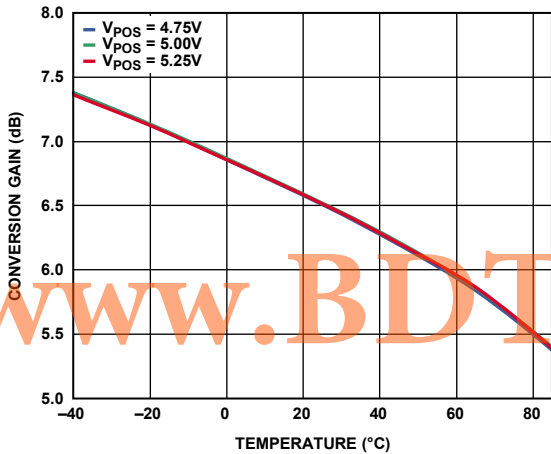

Figure 11. Power Conversion Gain vs. Temperature

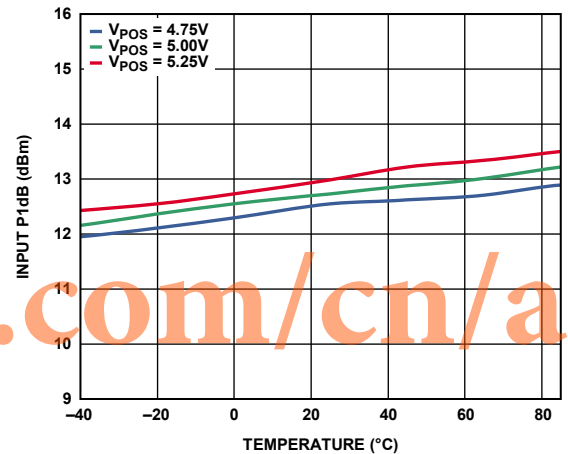

Figure 14. Input P1dB vs. Temperature

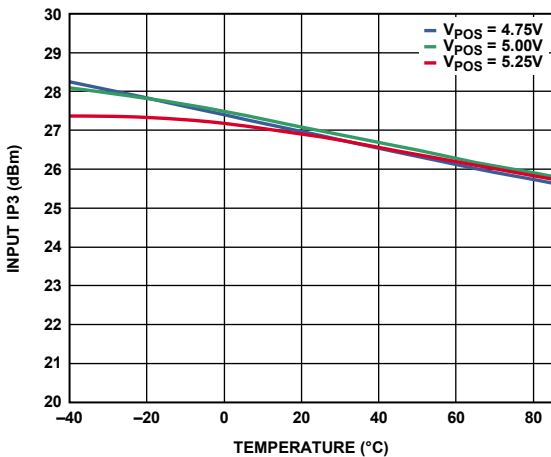

Figure 12. Input IP3 vs. Temperature

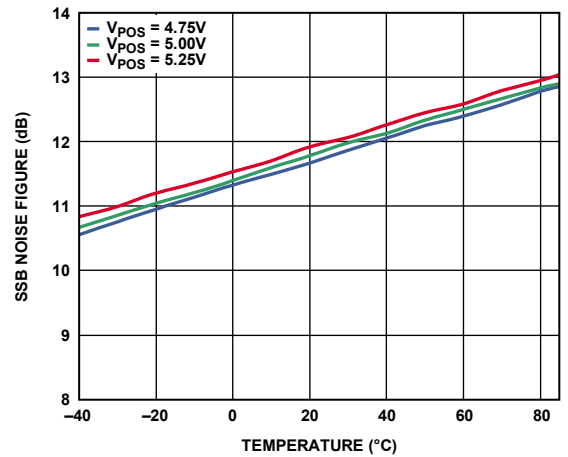

Figure 15. SSB Noise Figure vs. Temperature

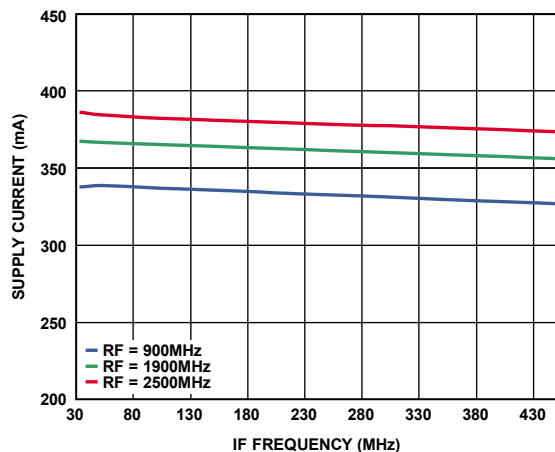

Figure 16. Supply Current vs. IF Frequency

08913-032

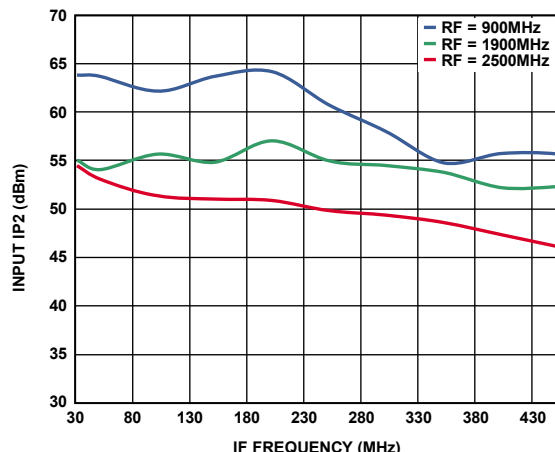

Figure 19. Input IP2 vs. IF Frequency

08913-035

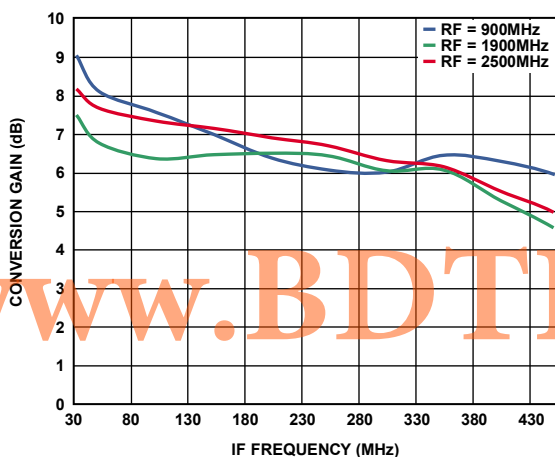

Figure 17. Power Conversion Gain vs. IF Frequency

08913-033

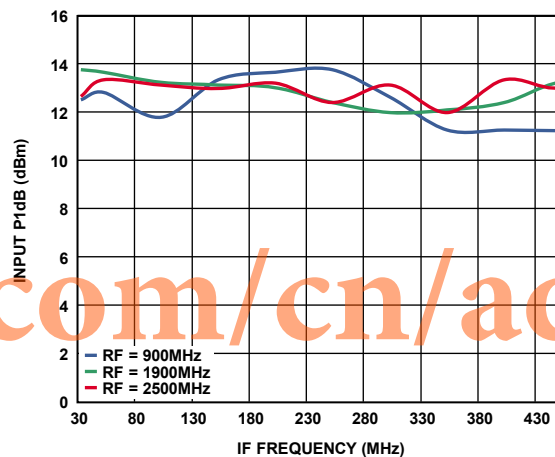

Figure 20. Input P1dB vs. IF Frequency

08913-036

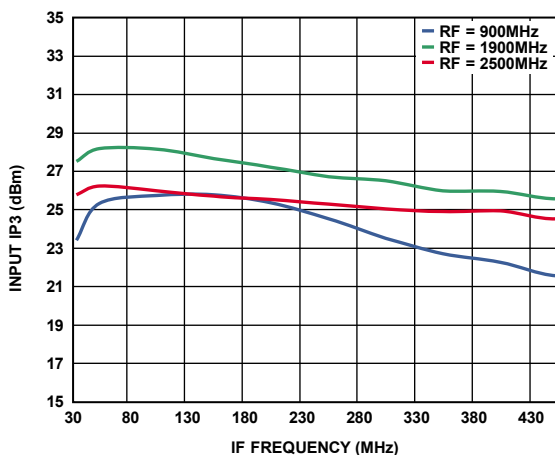

Figure 18. Input IP3 vs. IF Frequency

08913-034

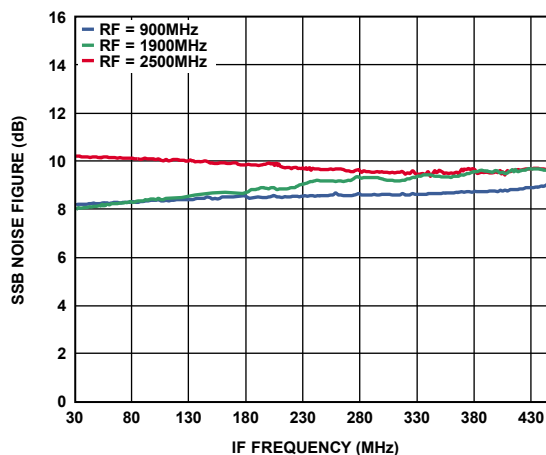

Figure 21. SSB Noise Figure vs. IF Frequency

08913-037

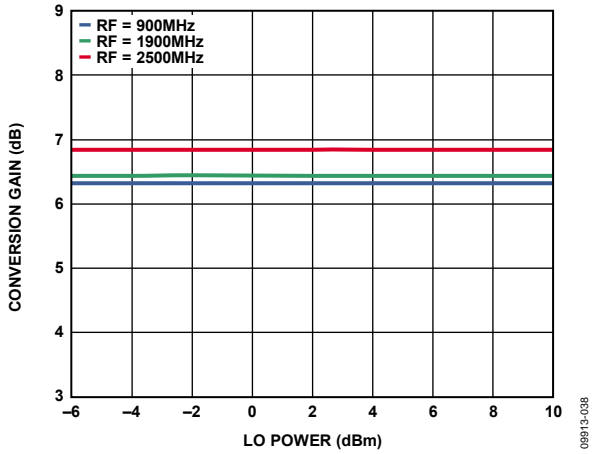

Figure 22. Power Conversion Gain vs. LO Power

08913-038

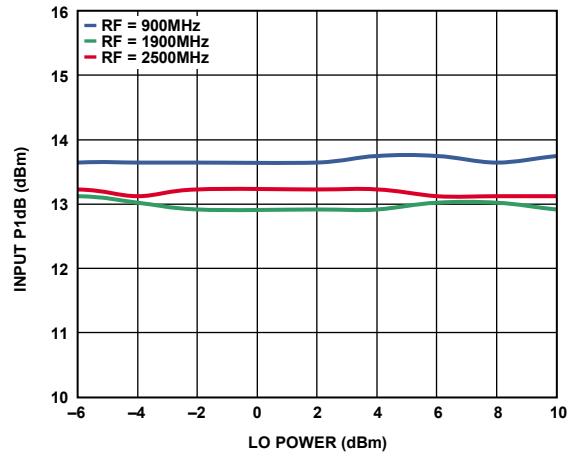

Figure 25. Input P1dB vs. LO Power

08913-041

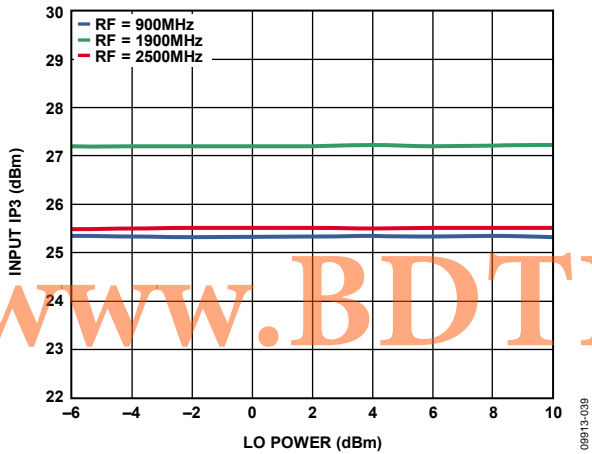

Figure 23. Input IP3 vs. LO Power

08913-039

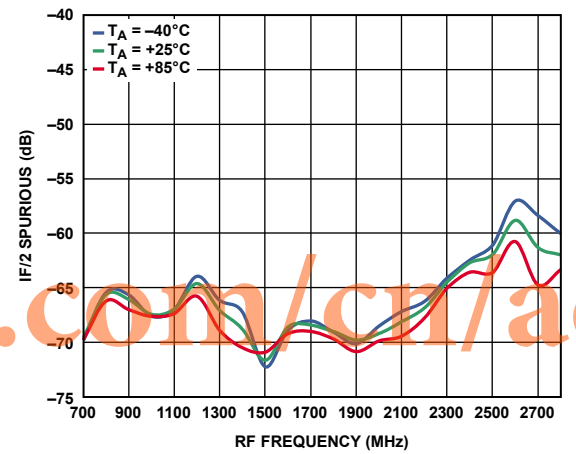

Figure 26. IF/2 Spurious vs. RF Frequency, RF Power = -10 dBm

08913-012

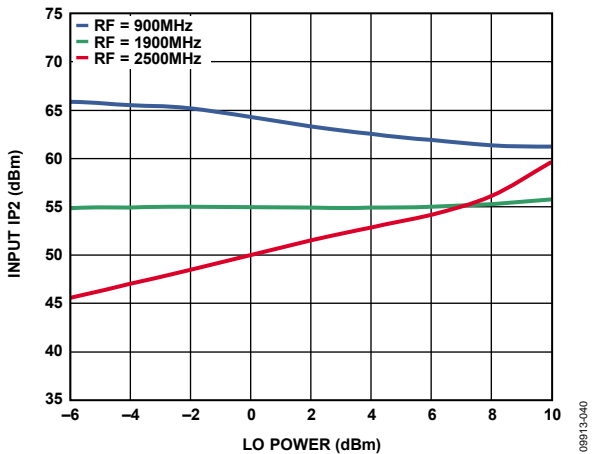

Figure 24. Input IP2 vs. LO Power

08913-040

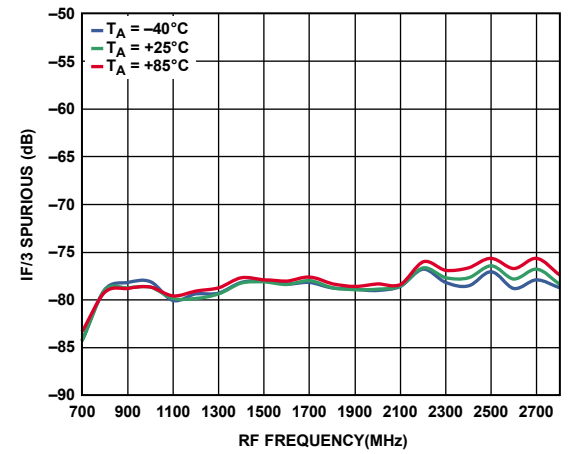

Figure 27. IF/3 Spurious vs. RF Frequency, RF Power = -10 dBm

08913-013

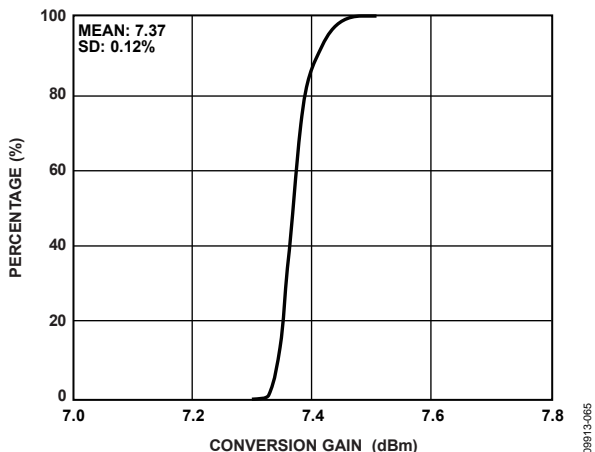

Figure 28. Conversion Gain Distribution

09913-065

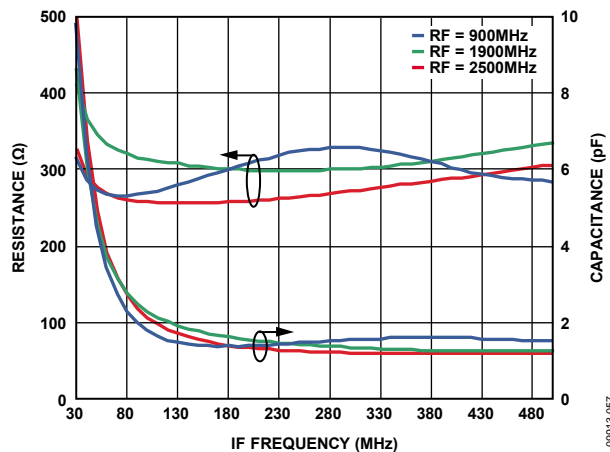

Figure 31. IF Output Impedance (R Parallel C Equivalent)

09913-057

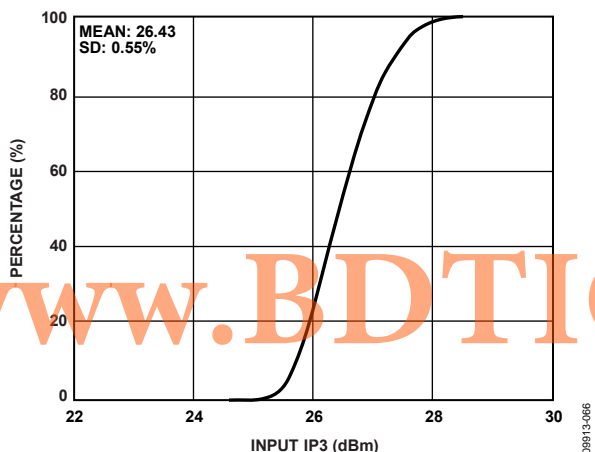

Figure 29. Input IP3 Distribution

09913-066

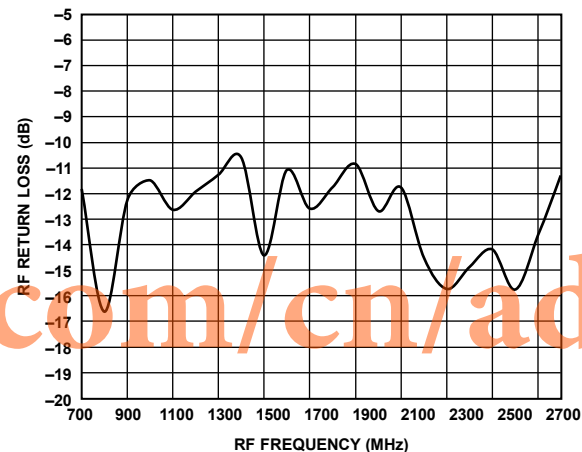

Figure 32. RF Port Return Loss, Fixed IF

09913-062

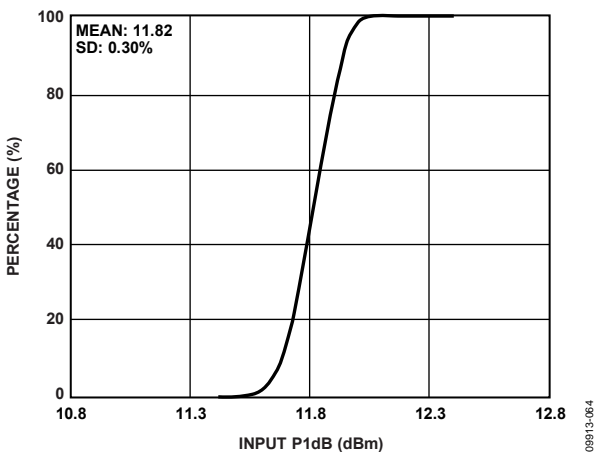

Figure 30. Input P1dB Distribution

09913-064

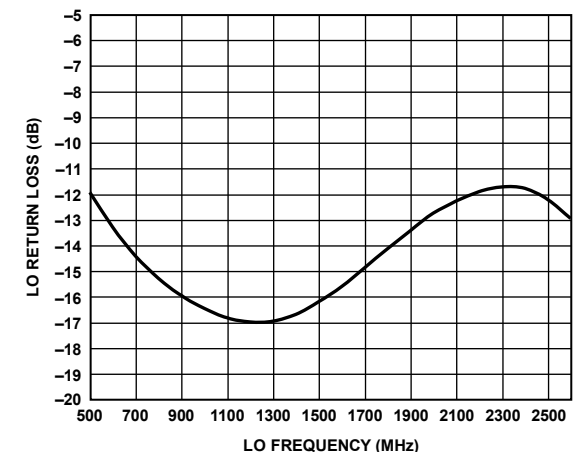

Figure 33. LO Return Loss

09913-060

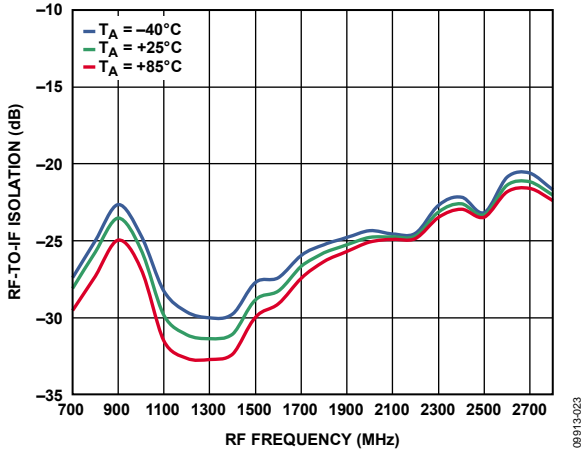

Figure 34. RF-to-IF Isolation vs. RF Frequency

08913-023

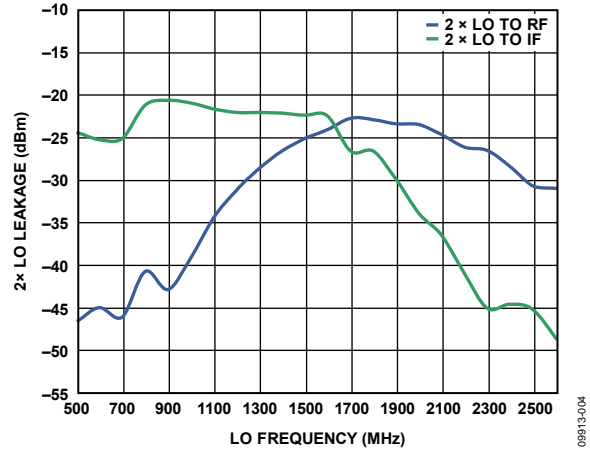

Figure 37. 2XLO Leakage vs. LO Frequency

08913-004

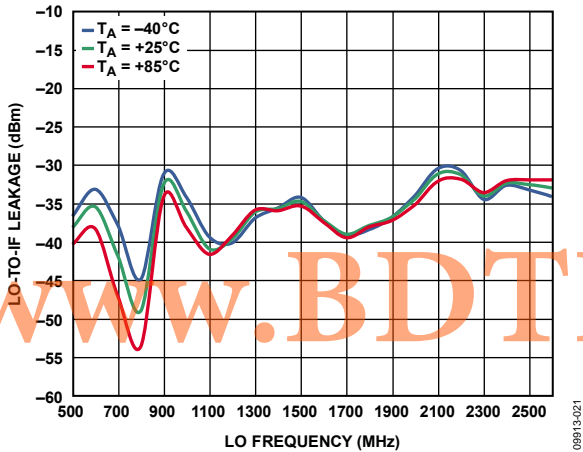

Figure 35. LO-to-IF Leakage vs. LO Frequency

08913-021

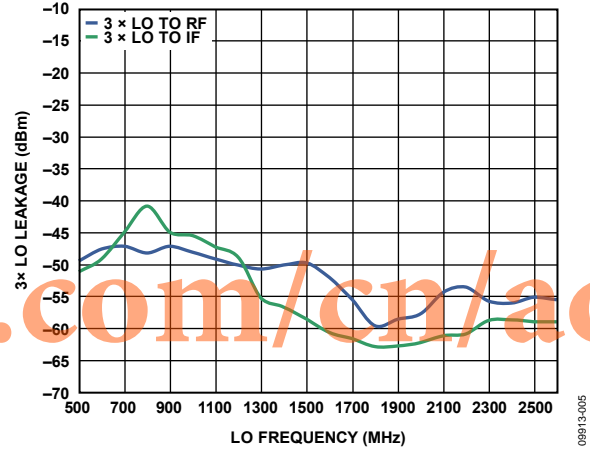

Figure 38. 3XLO Leakage vs. LO Frequency

08913-005

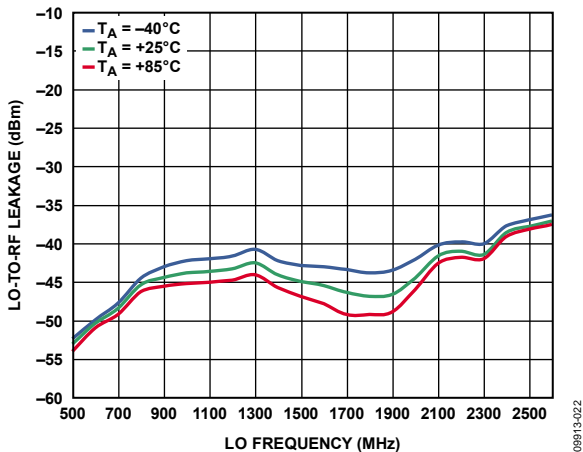

Figure 36. LO-to-RF Leakage vs. LO Frequency

08913-022

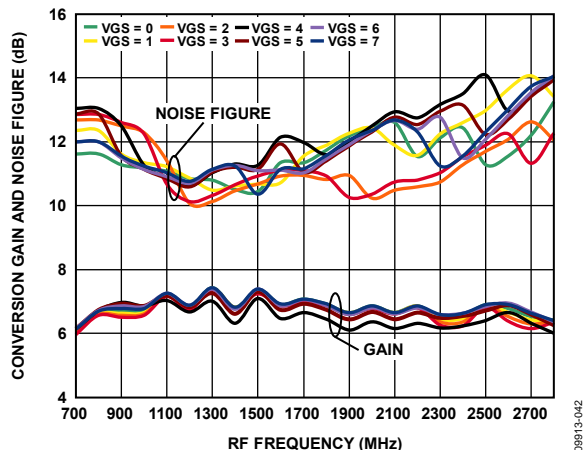

Figure 39. Power Conversion Gain and SSB Noise Figure vs. RF Frequency for All VGS Settings, RFB and LPF Use Optimum Settings

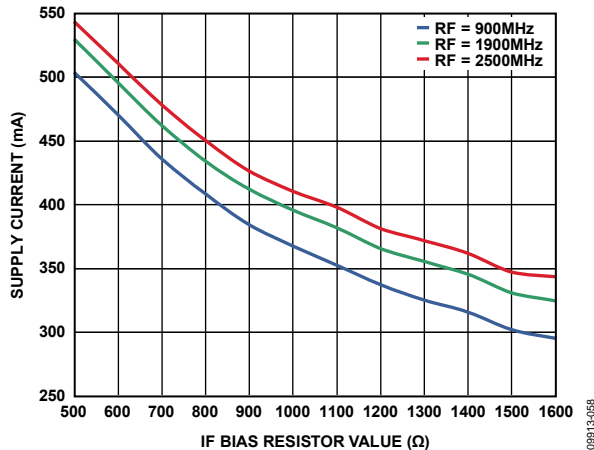

Figure 42. Supply Current vs. IF Bias Resistor Value

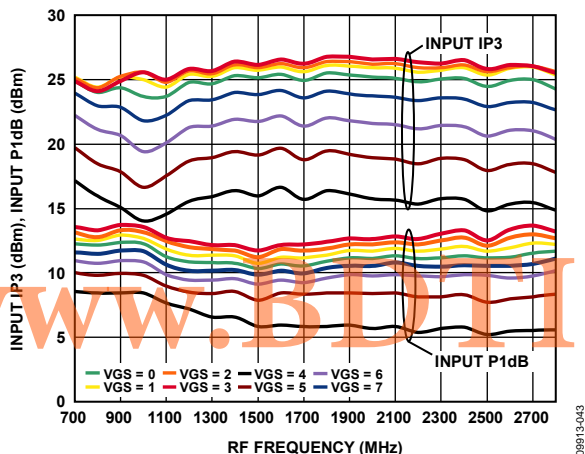

Figure 40. Input IP3 and Input P1dB vs. RF Frequency for All VGS Settings, RFB and LPF Use Optimum Settings

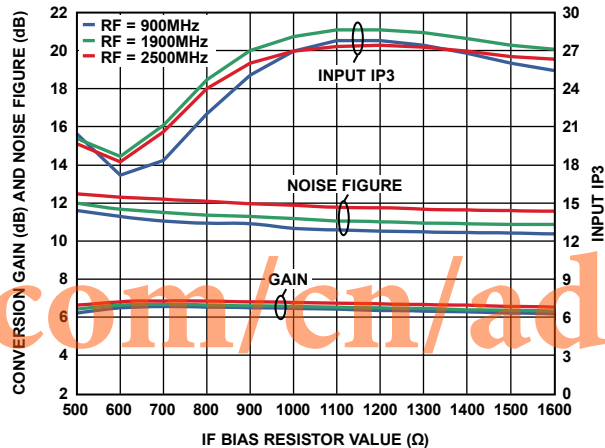

Figure 43. Power Conversion Gain, Noise Figure, and Input IP3 vs. IF Bias Resistor Value

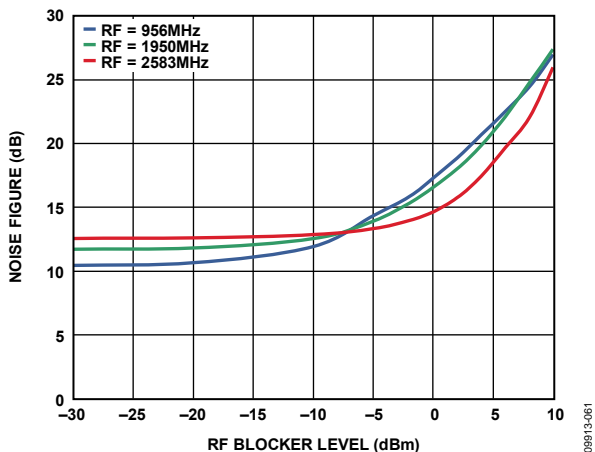

Figure 41. SSB Noise Figure vs. 10 MHz Offset Blocker Level

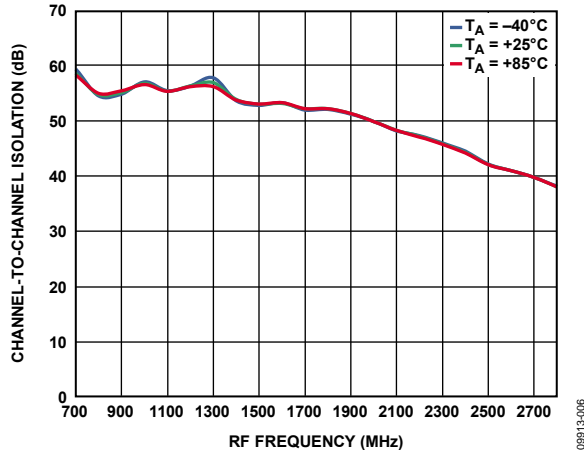

Figure 44. IF Channel-to-Channel Isolation vs. RF Frequency

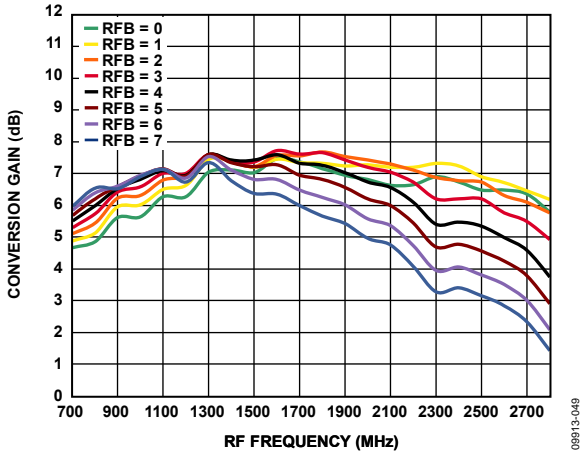

Figure 45. Conversion Gain vs. RF Frequency for All RFB Settings, VGS and LPF Use Optimum Settings

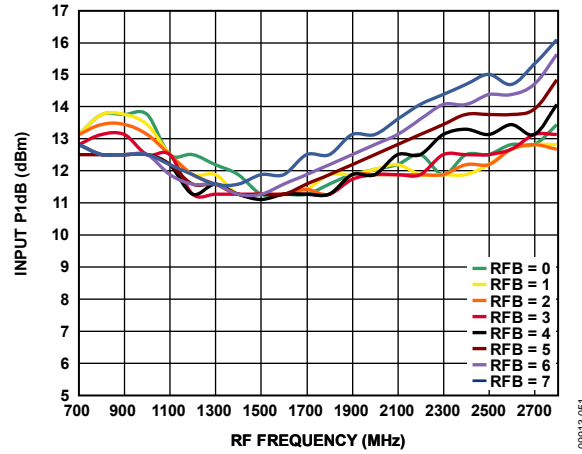

Figure 47. Input P1dB vs. RF Frequency for All RFB Settings, VGS and LPF Use Optimum Settings

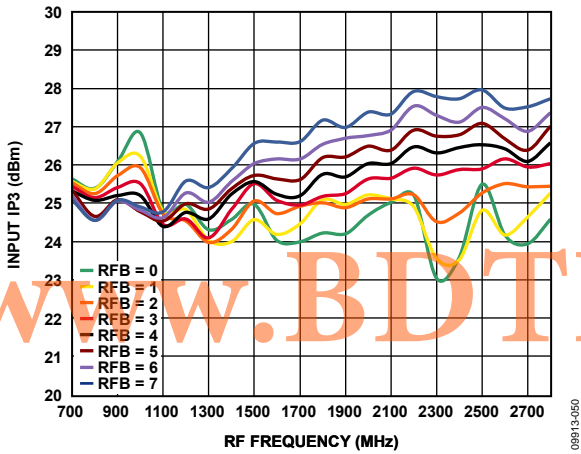

Figure 46. Input IP3 vs. RF Frequency for All RFB Settings, VGS and LPF Use Optimum Settings

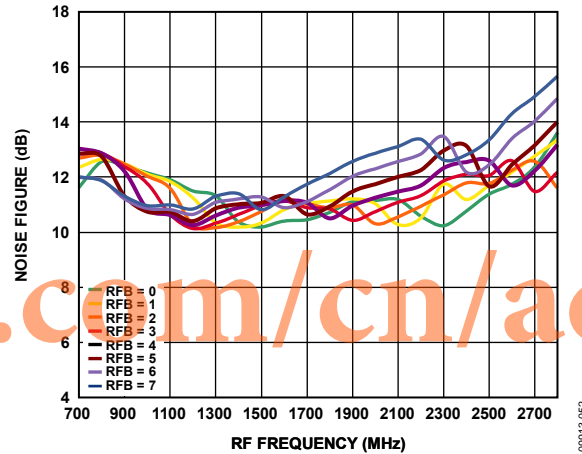

Figure 48. Noise Figure vs. RF Frequency for All RFB Settings, VGS and LPF Use Optimum Settings

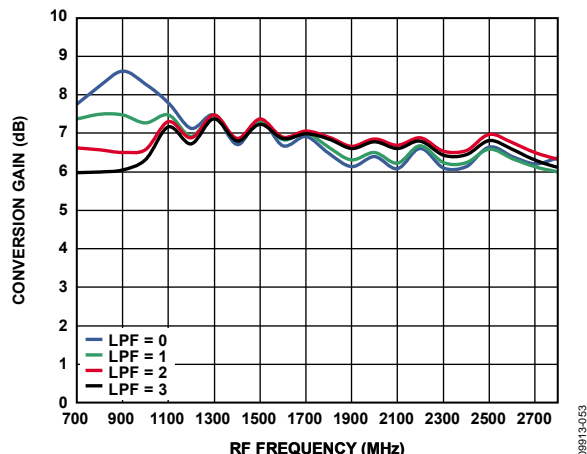

Figure 49. Conversion Gain vs. RF Frequency for All LPF Settings, RFB and VGS Use Optimum Settings

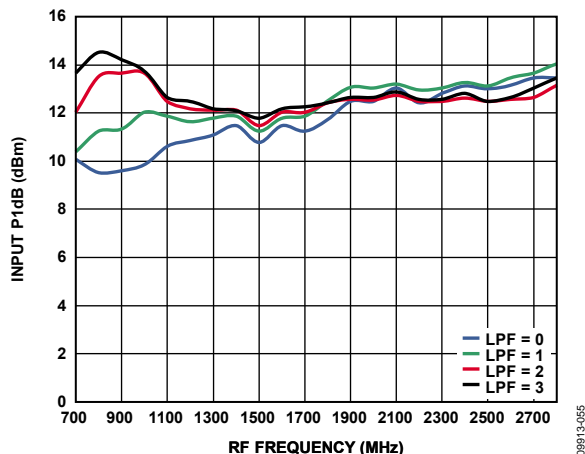

Figure 51. Input P1dB vs. RF Frequency for All LPF Settings, RFB and VGS Use Optimum Settings

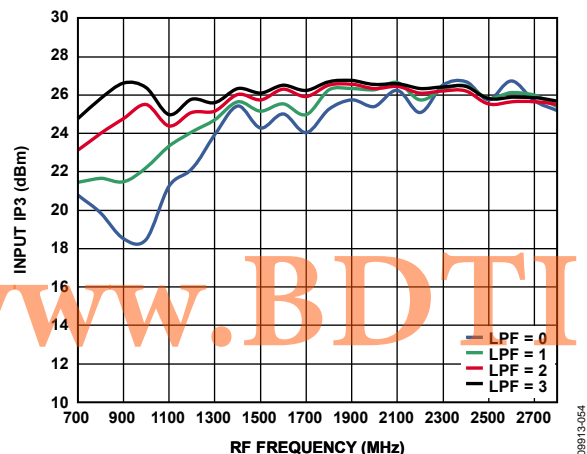

Figure 50. Input IP3 vs. RF Frequency for All LPF Settings, RFB and VGS Use Optimum Settings

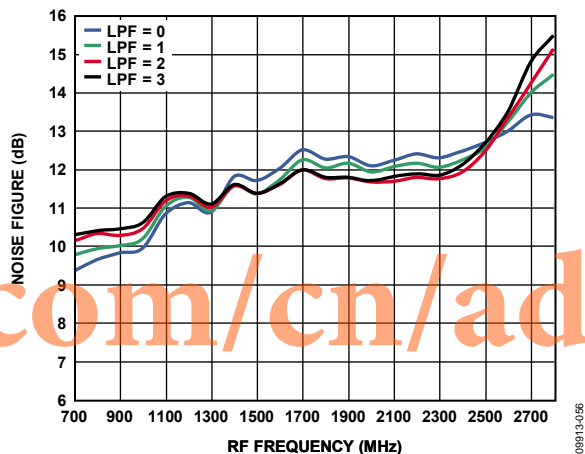

Figure 52. Noise Figure vs. RF Frequency for All LPF Settings, RFB and VGS Use Optimum Settings.

www.BDTIC.com/cn/adi



## 3.6 V PERFORMANCE

$V_S = 5\text{ V}$ ,  $T_A = 25^\circ\text{C}$ ,  $f_{RF} = 1900\text{ MHz}$ ,  $f_{LO} = 1697\text{ MHz}$ , RF power = -10 dBm, LO power = 0 dBm,  $R_1 = R_2 = 800\ \Omega$ ,  $Z_O = 50\ \Omega$ , optimum SPI settings, unless otherwise noted.

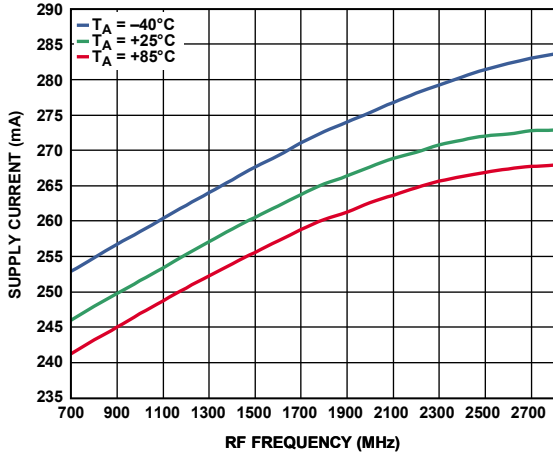

Figure 53. Supply Current vs. RF Frequency at 3.6 V

09913-044

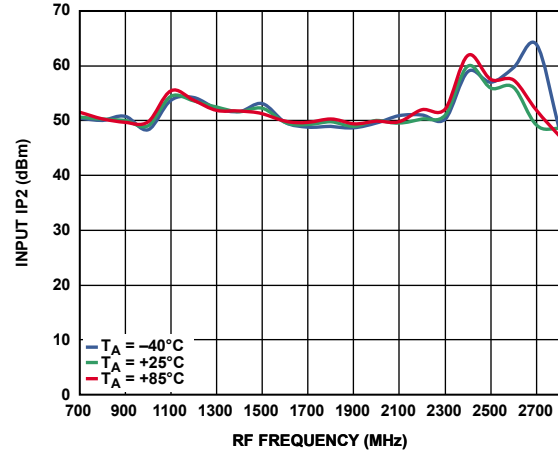

Figure 56. Input IP2 vs. RF Frequency at 3.6 V

09913-047

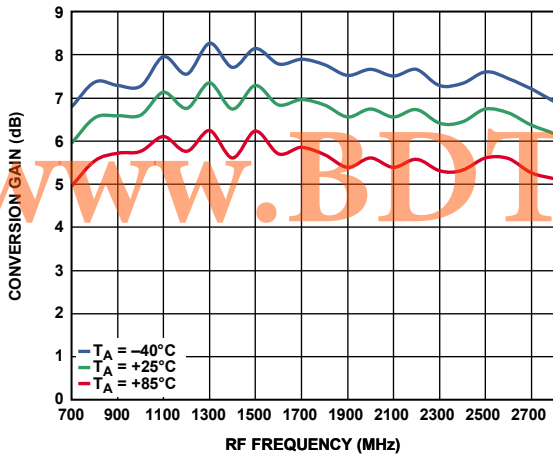

Figure 54. Power Conversion Gain vs. RF Frequency at 3.6 V

09913-045

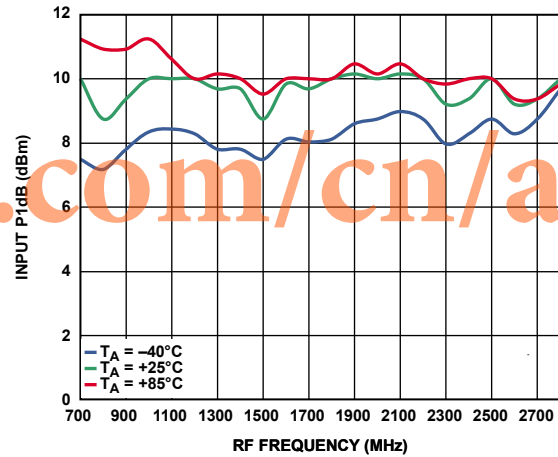

Figure 57. Input P1dB vs. RF Frequency at 3.6 V

09913-048

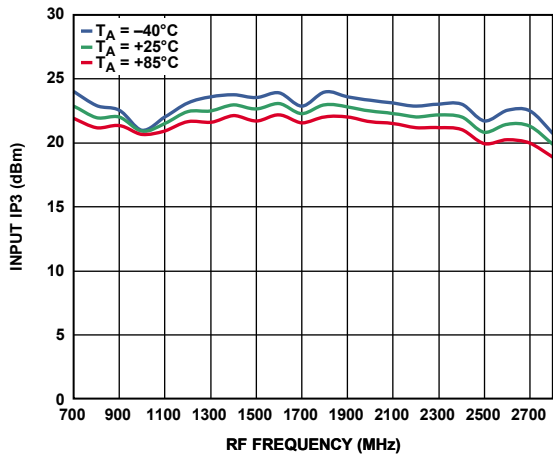

Figure 55. Input IP3 vs. RF Frequency at 3.6 V

09913-046

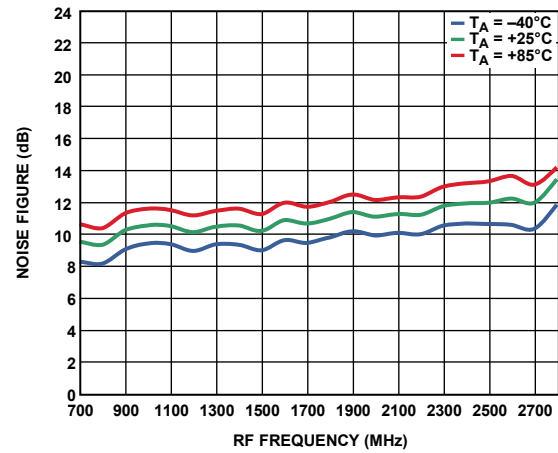

Figure 58. SSB Noise Figure vs. RF Frequency at 3.6 V

09913-063

**SPURIOUS PERFORMANCE**

$(N \times f_{RF}) - (M \times f_{LO})$  spur measurements were made using the standard evaluation board. Mixer spurious products are measured in dBc from the IF output power level. Data was only measured for frequencies less than 6 GHz. Typical noise floor of the measurement system = -100 dBm.

**5 V Performance**

$V_s = 5\text{ V}$ ,  $T_A = 25^\circ\text{C}$ , RF power = -10 dBm, LO power = 0 dBm,  $R_1 = R_2 = 1200\ \Omega$ ,  $Z_o = 50\ \Omega$ , optimum SPI settings, unless otherwise noted.

**Table 5. RF = 900 MHz, LO = 697 MHz**

		M														
		0	1	2	3	4	5	6	7	8	9	10	11	12	13	14
N	0		-38.6	-19.2	-37.5	-22.2	-48.1	-42.0	-63.0	-59.2						
	1	-30.4	0.0	-36.3	-19.2	-52.5	-41.5	-60.6	-53.8	-78.7	-64.8					
	2	-60.9	-54.1	-78.0	-54.1	-67.2	-77.8	-76.1	-97.7	-91.5	<-100	<-100	<-100			
	3	-86.0	-81.3	-97.8	-90.8	<-100	-90.2	-98.0	-99.3	<-100	<-100	<-100	<-100	<-100		
	4	-100.0	<-100	-94.9	<-100	<-100	<-100	<-100	<-100	<-100	<-100	<-100	<-100	<-100	<-100	
	5	<-100	<-100	<-100	<-100	<-100	<-100	<-100	<-100	<-100	<-100	<-100	<-100	<-100	<-100	<-100
	6	<-100	<-100	<-100	<-100	<-100	<-100	<-100	<-100	<-100	<-100	<-100	<-100	<-100	<-100	<-100
	7		<-100	<-100	<-100	<-100	<-100	<-100	<-100	<-100	<-100	<-100	<-100	<-100	<-100	<-100
	8			<-100	<-100	<-100	<-100	<-100	<-100	<-100	<-100	<-100	<-100	<-100	<-100	<-100
	9					<-100	<-100	<-100	<-100	<-100	<-100	<-100	<-100	<-100	<-100	<-100
	10						<-100	<-100	<-100	<-100	<-100	<-100	<-100	<-100	<-100	<-100
	11							<-100	<-100	<-100	<-100	<-100	<-100	<-100	<-100	<-100
	12								<-100	<-100	<-100	<-100	<-100	<-100	<-100	<-100
	13										<-100	<-100	<-100	<-100	<-100	<-100
	14											<-100	<-100	<-100	<-100	<-100
15												<-100	<-100	<-100	<-100	

**Table 6. RF = 1900 MHz, LO = 1697 MHz**

		M														
		0	1	2	3	4	5	6	7	8	9	10	11	12	13	14
N	0		-26.1	-25.2	-55.4											
	1	-26.1	0.0	-46.0	-54.5	-78.8										
	2	-70.8	-68.3	-71.9	-66.0	-80.4	-97.7									
	3	<-100	-91.4	-88.9	-76.3	-97.8	<-100	<-100								
	4		<-100	<-100	<-100	<-100	<-100	<-100	<-100	<-100						
	5				<-100	<-100	<-100	<-100	<-100	<-100	<-100					
	6					<-100	<-100	<-100	<-100	<-100	<-100	<-100				
	7						<-100	<-100	<-100	<-100	<-100	<-100	<-100			
	8							<-100	<-100	<-100	<-100	<-100	<-100	<-100		
	9								<-100	<-100	<-100	<-100	<-100	<-100	<-100	
	10									<-100	<-100	<-100	<-100	<-100	<-100	<-100
	11										<-100	<-100	<-100	<-100	<-100	<-100
	12											<-100	<-100	<-100	<-100	<-100
	13												<-100	<-100	<-100	<-100
	14													<-100	<-100	<-100
15															<-100	

# ADL5812

Table 7. RF = 2500 MHz, LO = 2297 MHz

		M														
		0	1	2	3	4	5	6	7	8	9	10	11	12	13	14
N	0	0	-29.3	-41.2												
	1	-26.2	0.0	-45.0	-46.1											
	2	-84.5	-72.0	-57.9	-67.1	-96.5										
	3		<-100	-87.7	-83.4	<-100	<-100									
	4			<-100	<-100	<-100	<-100	<-100								
	5				<-100	<-100	<-100	<-100	<-100	<-100						
	6					<-100	<-100	<-100	<-100	<-100	<-100					
	7							<-100	<-100	<-100	<-100	<-100				
	8								<-100	<-100	<-100	<-100	<-100			
	9									<-100	<-100	<-100	<-100	<-100		
	10										<-100	<-100	<-100	<-100	<-100	
	11											<-100	<-100	<-100	<-100	<-100
	12												<-100	<-100	<-100	<-100
	13													<-100	<-100	<-100
	14														<-100	<-100
15															<-100	

### 3.6 V Performance

$V_s = 5\text{ V}$ ,  $T_A = 25^\circ\text{C}$ , RF power = -10 dBm, LO power = 0 dBm,  $R_1 = R_2 = 800\ \Omega$ ,  $Z_o = 50\ \Omega$ , optimum SPI settings, unless otherwise noted.

Table 8. RF = 900 MHz, LO = 697 MHz

		M														
		0	1	2	3	4	5	6	7	8	9	10	11	12	13	14
N	0		-44.7	-24.2	-35.2	-25.5	-46.6	-45.9	-64.1	-65.9						
	1	-30.9	0.0	-34.6	-19.9	-57.5	-39.2	-59.8	-50.8	-76.1	-60.0					
	2	-69.9	-56.7	-79.4	-57.4	-65.0	-76.9	-77.5	-92.8	-85.8	<-100	<-100	<-100			
	3	-84.9	-78.6	-95.9	-82.8	-96.0	-80.8	<-100	-96.7	<-100	<-100	<-100	<-100	<-100		
	4	<-100	<-100	-94.6	<-100	<-100	<-100	<-100	<-100	<-100	<-100	<-100	<-100	<-100	<-100	<-100
	5	<-100	<-100	<-100	<-100	<-100	<-100	<-100	<-100	<-100	<-100	<-100	<-100	<-100	<-100	<-100
	6	<-100	<-100	<-100	<-100	<-100	<-100	<-100	<-100	<-100	<-100	<-100	<-100	<-100	<-100	<-100
	7		<-100	<-100	<-100	<-100	<-100	<-100	<-100	<-100	<-100	<-100	<-100	<-100	<-100	<-100
	8			<-100	<-100	<-100	<-100	<-100	<-100	<-100	<-100	<-100	<-100	<-100	<-100	<-100
	9					<-100	<-100	<-100	<-100	<-100	<-100	<-100	<-100	<-100	<-100	<-100
	10						<-100	<-100	<-100	<-100	<-100	<-100	<-100	<-100	<-100	<-100
	11							<-100	<-100	<-100	<-100	<-100	<-100	<-100	<-100	<-100
	12								<-100	<-100	<-100	<-100	<-100	<-100	<-100	<-100
	13									<-100	<-100	<-100	<-100	<-100	<-100	<-100
	14														<-100	<-100
15															<-100	

Table 9. RF = 1900 MHz, LO = 1697 MHz

		M														
		0	1	2	3	4	5	6	7	8	9	10	11	12	13	14
N	0		-32.6	-29.0	-60.9											
	1	-34.0	0.0	-53.6	-56.6	-86.3										
	2	-72.9	-72.4	-82.0	-73.1	-76.8	<-100									
	3	<-100	<-100	<-100	-73.5	-95.9	<-100	<-100								
	4		<-100	<-100	<-100	<-100	<-100	<-100	<-100	<-100						
	5				<-100	<-100	<-100	<-100	<-100	<-100	<-100					
	6					<-100	<-100	<-100	<-100	<-100	<-100	<-100				
	7						<-100	<-100	<-100	<-100	<-100	<-100	<-100			
	8							<-100	<-100	<-100	<-100	<-100	<-100	<-100		
	9								<-100	<-100	<-100	<-100	<-100	<-100	<-100	
	10									<-100	<-100	<-100	<-100	<-100	<-100	<-100
	11										<-100	<-100	<-100	<-100	<-100	<-100
	12											<-100	<-100	<-100	<-100	<-100
	13													<-100	<-100	<-100
	14														<-100	<-100
15															<-100	

Table 10. RF = 2500 MHz, LO = 2297 MHz

		M														
		0	1	2	3	4	5	6	7	8	9	10	11	12	13	14
N	0		-24.9	-49.5												
	1	-30.5	0.0	-46.6	-52.0											
	2	-92.7	-78.3	-60.1	-68.5	-95.6										
	3	<-100	<-100	-96.3	-71.2	<-100	<-100									
	4		<-100	<-100	<-100	<-100	<-100	<-100								
	5				<-100	<-100	<-100	<-100	<-100	<-100						
	6					<-100	<-100	<-100	<-100	<-100	<-100					
	7							<-100	<-100	<-100	<-100	<-100				
	8								<-100	<-100	<-100	<-100	<-100			
	9									<-100	<-100	<-100	<-100	<-100		
	10										<-100	<-100	<-100	<-100	<-100	
	11											<-100	<-100	<-100	<-100	<-100
	12												<-100	<-100	<-100	<-100
	13													<-100	<-100	<-100
	14														<-100	<-100
15															<-100	

## CIRCUIT DESCRIPTION

The ADL5812 consists of two primary components: the RF subsystem and the LO subsystem. The combination of design, process, and packaging technology allows the functions of these subsystems to be integrated into a single die, using mature packaging and interconnection technologies to provide a high performance device with excellent electrical, mechanical, and thermal properties. The wideband frequency response and flexible frequency programming simplifies the receiver design, saves on-board space, and minimizes the need for external components.

The RF subsystem consists of an integrated, tunable, low loss RF balun; a double balanced, passive MOSFET mixer; a tunable sum termination network; and an IF amplifier.

The LO subsystem consists of a multistage limiting LO amplifier. The purpose of the LO subsystem is to provide a large, fixed amplitude, balanced signal to drive the mixer independent of the level of the LO input. A block diagram of the device is shown in Figure 59.

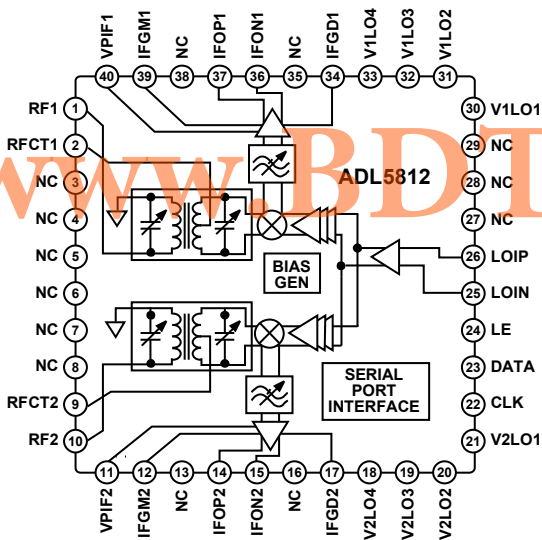

Figure 59. Simplified Schematic

### RF SUBSYSTEM

The single-ended, 50 Ω RF input is internally transformed to a balanced signal using a tunable, low loss, unbalanced-to-balanced (balun) transformer. This transformer is made possible by an extremely low loss metal stack, which provides both excellent balance and dc isolation for the RF port. Although the port can be dc connected, it is recommended that a blocking capacitor be used to avoid running excessive dc current through the part. The RF balun can easily support an RF input frequency range of 700 MHz to 2800 MHz. This balun is tuned over the frequency range by SPI controlled switched capacitor networks at the input and output of the RF balun.

The resulting balanced RF signal is applied to a passive mixer that commutates the RF input in accordance with the output of the LO subsystem. The passive mixer is essentially a balanced, low loss switch that adds minimum noise to the frequency translation. The only noise contribution from the mixer is due to the resistive loss of the switches, which is in the order of a few ohms.

Because the mixer is inherently broadband and bidirectional, it is necessary to properly terminate all idler ( $M \times N$  product) frequencies generated by the mixing process. Terminating the mixer avoids the generation of unwanted intermodulation products and reduces the level of unwanted signals at the input of the IF amplifier, where high peak signal levels can compromise the compression and intermodulation performance of the system. This termination is accomplished by the addition of a programmable low-pass filter network between the IF amplifier and the mixer and in the feedback elements in the IF amplifier.

The IF amplifier is a balanced feedback design that simultaneously provides the desired gain, noise figure, and input impedance that is required to achieve the overall performance. The balanced open-collector output of the IF amplifier, with an impedance modified by the feedback within the amplifier, permits the output to be connected directly to a high impedance filter, a differential amplifier, or an analog-to-digital converter (ADC) input while providing optimum second-order intermodulation suppression. The differential output impedance of the IF amplifier is approximately 200 Ω. If operation in a 50 Ω system is desired, the output can be transformed to 50 Ω by using a 4:1 transformer or an LC impedance matching network.

The intermodulation performance of the design is generally limited by the IF amplifier. The IP3 performance can be optimized by adjusting the low-pass filter between the mixer and the IF amplifier. Further optimization can be made by adjusting the IF current with an external resistor. Figure 42 and Figure 43 illustrate how various IF resistors affect the performance with a 5 V supply. Additionally, dc current can be saved by increasing the IF resistor. It is permissible to reduce the IF amplifier's dc supply voltage to as low as 3.3 V, further reducing the dissipated power of the part. (Note that no performance enhancement is obtained by reducing the value of these resistors, and excessive dc power dissipation may result.)

Because the mixer is bidirectional, the tuning of the RF and IF ports is linked, and it is possible for the user to optimize gain, noise figure, IP3, and impedance match via the SPI. This feature permits high performance operation and is achieved entirely using SPI control. Additionally, the performance of the mixer can be improved by setting the optimum gate voltage on the passive mixer, which is also controlled by the SPI to enable optimum performance of the part. See the Applications Information section for examples of this tuning.

## LO SUBSYSTEM

The LO amplifier is designed to provide a large signal level to the mixer to obtain optimum intermodulation and compression performance. The resulting LO amplifier provides very high performance over a wide range of LO input frequencies.

The ideal waveshape for switching the passive mixer is a square wave at the LO frequency to cause the mixer to switch through its resistive region (from on to off and off to on) as rapidly as possible. While it has always been possible to generate such a square wave, the amount of dc current required to generate a large amplitude square wave at high frequencies has made it impractical to create such a mixer. Novel circuitry within the [ADL5812](#) permits the generation of a near-square wave output at frequencies up to 2800 MHz with dc current that compares favorably with that employed by narrow-band passive mixers.

The input stages of the LO amplifier provide common-mode rejection, permitting the LO input to be driven either single ended or balanced. For a single-ended input, either LOIP or LOIN can be grounded. It is desirable to dc block the LO inputs to avoid damaging the part by the accidental application of a large dc voltage to the part. In addition, the LO inputs are internally dc blocked.

Because the LO amplifier is inherently wideband, the [ADL5812](#) can be driven with either high-side or low-side LO by simply setting the optimum RF balun and LPF inputs to the SPI.

The LO amplifier converts a variable level, single or balanced input signal (–6 dBm to +10 dBm) to a hard voltage limited, balanced signal internally to drive the mixer. Excellent performance can be obtained with a 0 dBm input level; however, the circuit continues to function at considerably lower levels of LO input power.

The performance of this amplifier is critical in achieving a high intercept passive mixer without degrading the noise floor of the system. This is a critical requirement in an interferer rich environment, such as cellular infrastructure, where blocking interferers can limit mixer performance. Blocking dynamic range can benefit from a higher level of LO drive, which pushes the LO amplifier stages harder into compression and causes them to switch harder and to limit the small signal gain of the chain. Both of these conditions are beneficial to low noise figure under blocking. NF under blocking can be improved several decibels for LO input power levels above 0 dBm.

The LO amplifier topology inherently minimizes the dc current based on the LO operating voltage and the LO operating frequency. It is permissible to reduce the LO supply voltage down as low as 3.6 V, which drops the dc current rapidly. The mixer dynamic range varies accordingly with the LO supply voltage. No external biasing resistor is required for optimizing the LO amplifier.

In addition, the [ADL5812](#) has a power-down mode. This power-down mode can be used with any supply voltage applied to the part.

All of the SPI inputs are designed to work with any logic family that provides a Logic 0 input level of less than 0.4 V and a Logic 1 input level that exceeds 1.4 V.

All pins, including the RF pins, are ESD protected and have been tested up to a level of 2000 V HBM and 1250 V CDM.

## APPLICATIONS INFORMATION

### BASIC CONNECTIONS

The ADL5812 mixer is designed to downconvert radio frequencies (RF) primarily between 700 MHz and 2800 MHz to lower intermediate frequencies (IF) between 30 MHz and 450 MHz. Figure 60 depicts the basic connections of the mixer. It is recommended to ac couple RF and LO input ports to prevent nonzero dc voltages from damaging the RF balun or LO input circuit. A RFIN capacitor value of 22 pF is recommended.

### IF PORT

The mixer differential IF interface requires pull-up choke inductors to bias the open-collector outputs and to set the output match. The shunting impedance of the choke inductors used to couple dc current into the IF amplifier should be selected to provide the desired output return loss.

The real part of the output impedance is approximately 200  $\Omega$ , as seen in Figure 31, which matches many commonly used SAW filters without the need for a transformer. This results in a voltage conversion gain that is approximately 6 dB higher than the power conversion gain. When a 50  $\Omega$  output impedance is needed, use a 4:1 impedance transformer, as shown in Figure 60.

### BIAS RESISTOR SELECTION

External resistors, R1 and R2, are used to adjust the bias current of the integrated amplifier at the IF terminal. It is necessary to have a sufficient amount of current to bias both the internal IF amplifier to optimize dc current vs. optimum input IP3 performance. Figure 42 and Figure 43 provide the reference for the bias resistor selection when lower power consumption is considered at the expense of conversion gain and input IP3 performance.

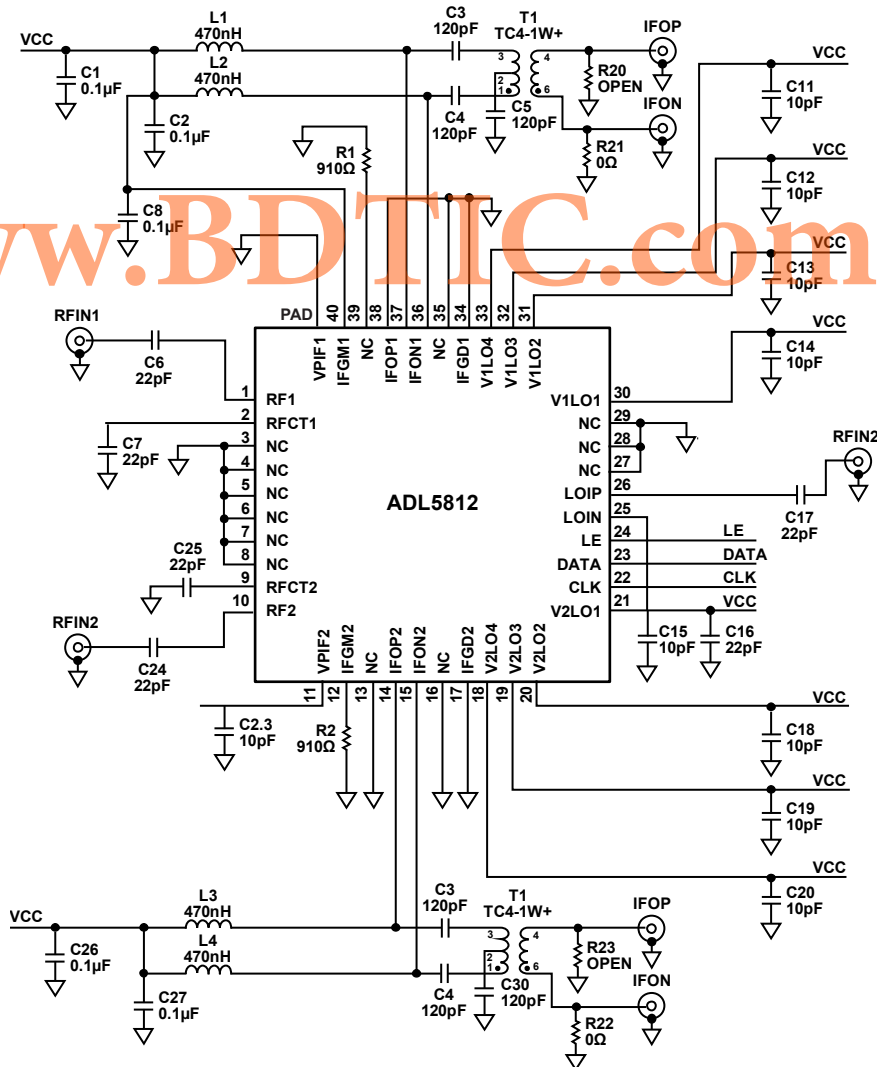

Figure 60. Evaluation Board Schematic

08913-070

### VGS PROGRAMMING

The ADL5812 allows programmability for internal gate-to-source voltages for optimizing mixer performance over the desired frequency bands. The ADL5812 defaults the VGS setting to 0. Both channels of the ADL5812 are programmed together using the same VGS setting. Power conversion gain, input IP3, NF, and input P1dB can be optimized, as shown in Figure 39 and Figure 40.

### LOW-PASS FILTER PROGRAMMING

The ADL5812 allows programmability for the low-pass filter terminating the mixer output. This filter helps to block sum term mixing products at the expense of some noise figure and gain and can significantly increase input IP3. The ADL5812 defaults the LPF setting to 0. Both channels of the ADL5812 are programmed together using the same LPF settings. Power conversion gain, input IP3, NF, and input P1dB can be optimized, as shown in Figure 49 to Figure 52.

### RF BALUN PROGRAMMING

The ADL5812 allows programmability for the RF balun by allowing capacitance to be switched into both the input and the output, which allows the balun to be tuned to cover the entire frequency band (700 MHz to 2800 MHz). Under most circumstances, the input and output can be tuned together though sometimes it may be advantageous for matching reasons to tune them separately. The ADL5812 defaults the RFB setting to 0. Both channels of the ADL5812 are programmed together using the same RFB settings. Power conversion gain, input IP3, NF, and input P1dB can be optimized, as shown in Figure 45 and Figure 48.

[www.BDTIC.com/cn/adi](http://www.BDTIC.com/cn/adi)



## REGISTER STRUCTURE

Figure 61 illustrates the register map of the ADL5812. The ADL5812 uses only Register 5. Because of this, set all of the control bits to five. When set to 0, the MAIN ENB and DIV ENB bits, DB7 and DB6, respectively, enable the part. By setting one of these bits to 1, its channel is powered down. Either channel can be powered down independently of the other. The RFB IN CAP DAC and RFB OUT CAP DAC bits are used to tune the RF balun. In most cases, they are tuned together with the higher settings, 7, tuning for the low frequencies, and with the lower settings, 0, tuning for the high frequencies. There are times where it becomes advantageous to tune the input and

output of the RF balun separately and that ability is provided. The LPF bits control the low-pass filter settings at the IF output. The ability to tune the low-pass filter allows some trade-off between gain, noise figure, and input IP3 with higher settings, 3, providing higher input IP3 at the cost of some gain and noise figure and lower settings, 0, providing higher gain and lower NF at the cost of lower input IP3. The VGS control the VGS settings of the mixer core and allow further tuning of the device.

Table 11 lists the optimum settings characterized for each frequency band. All register bits default to 0.

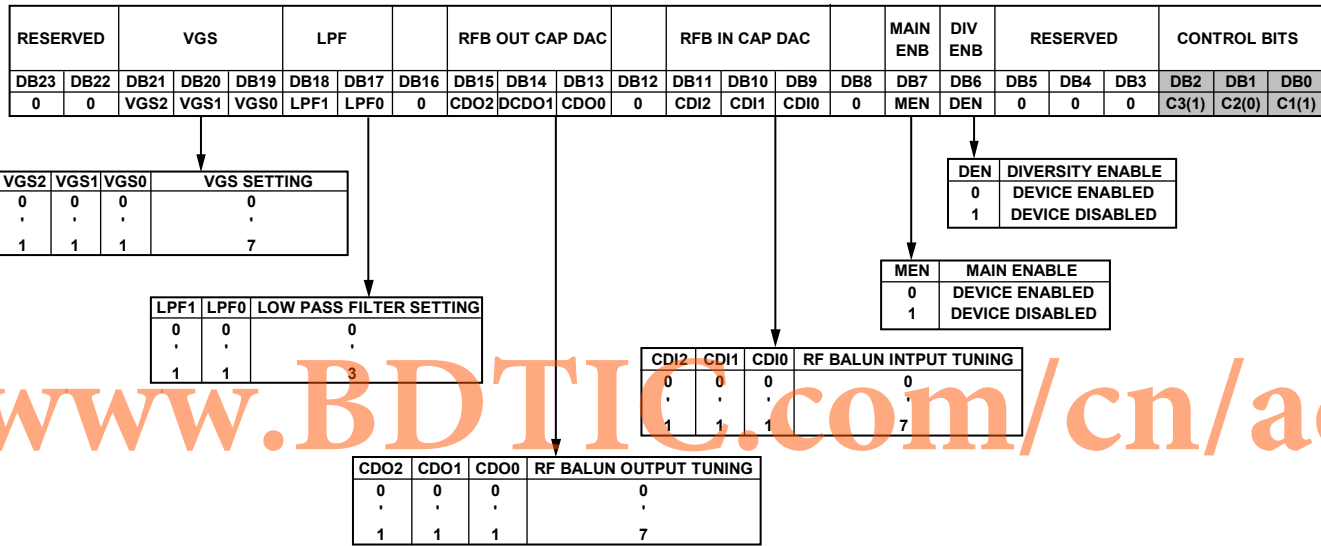

Figure 61. ADL5812 Register Maps

Table 11. Optimum Settings

RF Frequency (MHz)	LO Frequency (MHz)	VGS	LPF	RFB OUT CAP DAC	RFB IN CAP DAC
700	497	3	3	7	7
800	597	3	2	7	7
900	697	3	2	4	4
1000	797	3	2	3	3
1100	897	3	3	7	7
1200	997	3	3	7	7
1300	1097	3	3	7	7
1400	1197	3	3	7	7
1500	1297	3	3	5	5
1600	1397	3	3	6	6
1700	1497	3	3	5	5
1800	1597	3	3	5	5
1900	1697	3	3	5	5
2000	1797	3	3	4	4
2100	1897	3	3	4	4
2200	1997	3	3	3	3
2300	2097	3	1	3	3
2400	2197	3	1	3	3
2500	2297	3	3	2	2
2600	2397	3	1	2	2
2700	2497	3	1	2	2
2800	2597	3	2	1	1

## EVALUATION BOARD

An evaluation board is available for the [ADL5812](#). The standard evaluation board schematic is presented in Figure 62. The USB interface circuitry schematic is presented in Figure 65. The evaluation board layout is shown in Figure 63 and Figure 64.

The evaluation board is fabricated using Rogers® 3003 material. Table 12 details the configuration for the mixer characterization. The evaluation board software is available on [www.analog.com](http://www.analog.com).

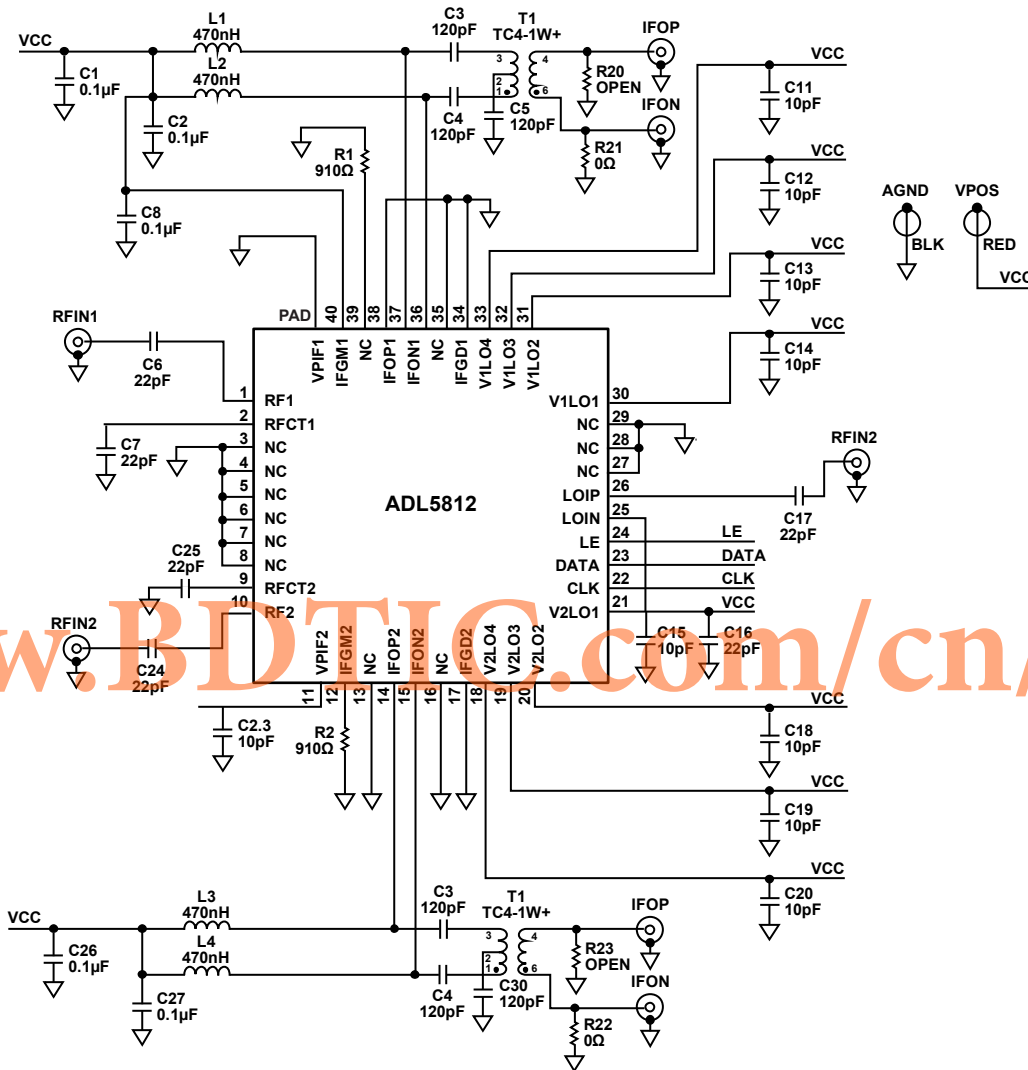

Figure 62. Evaluation Board Schematic

Table 12. Evaluation Board Configuration

Components	Description	Default Conditions
C1, C2, C8, C11, C12, C13, C14, C15, C18, C19, C20, C23, C26, C27	Power supply decoupling. Nominal supply decoupling consists of a 0.1 $\mu\text{F}$ capacitor to ground in parallel with a 10 pF capacitor to ground positioned as close to the device as possible.	C1, C2, C26, C27 = 0.1 $\mu\text{F}$ (size 0402), C8, C11, C12, C13, C14, C15, C18, C19, C20, C23 = 10 pF (size 0402)
C6, C7, C24, C25	RF input interface. The input channels are ac-coupled through C6 and C24. C7 and C25 provide bypassing for the center tap of the RF input baluns.	C6, C24 = 22 pF (size 0402), C7, C25 = 22 pF (size 0402)
C3, C4, C5, C28, C29, C30, L1, L2, L3, L4, R20, R21, R22, R23, T1, T2	IF output interface. The open-collector IF output interfaces are biased through pull-up choke inductors L1, L2, L3, and L4. T1 and T2 are 4:1 impedance transformers used to provide single-ended IF output interfaces, with C5 and C30 providing center-tap bypassing. Remove R21 and R22 for balanced output operation.	C3, C4, C5, C28, C29, C30 = 120 pF (size 0402), L1, L2, L3, L4 = 470 nH (size 0603), R20, R23 = open, R21, R22 = 0 $\Omega$ (size 0402), T1, T2 = TC4-1W+ (Mini-Circuits®)
C17	LO interface. C17 provides ac coupling for the LOIP local oscillator input.	C17 = 22 pF (size 0402)
R1, R2	Bias control. R1 and R2 set the bias point for the internal IF amplifier.	R1, R2 = 910 $\Omega$ (size 0402)

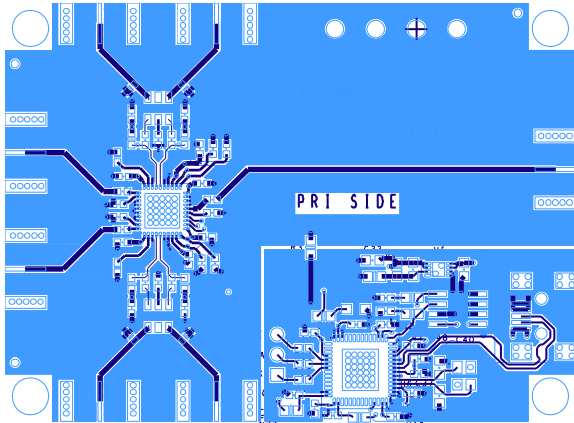

Figure 63. Evaluation Board Top Layer

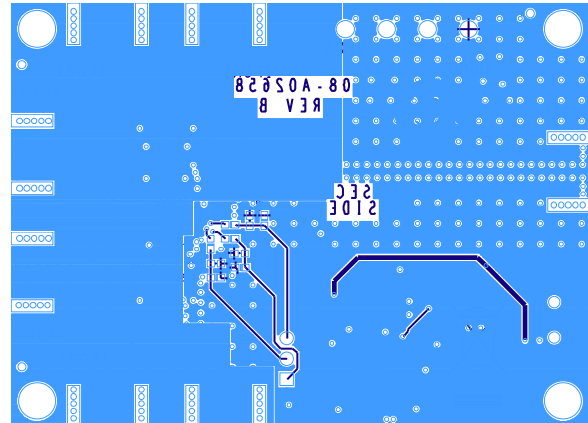

Figure 64. Evaluation Board Bottom Layer

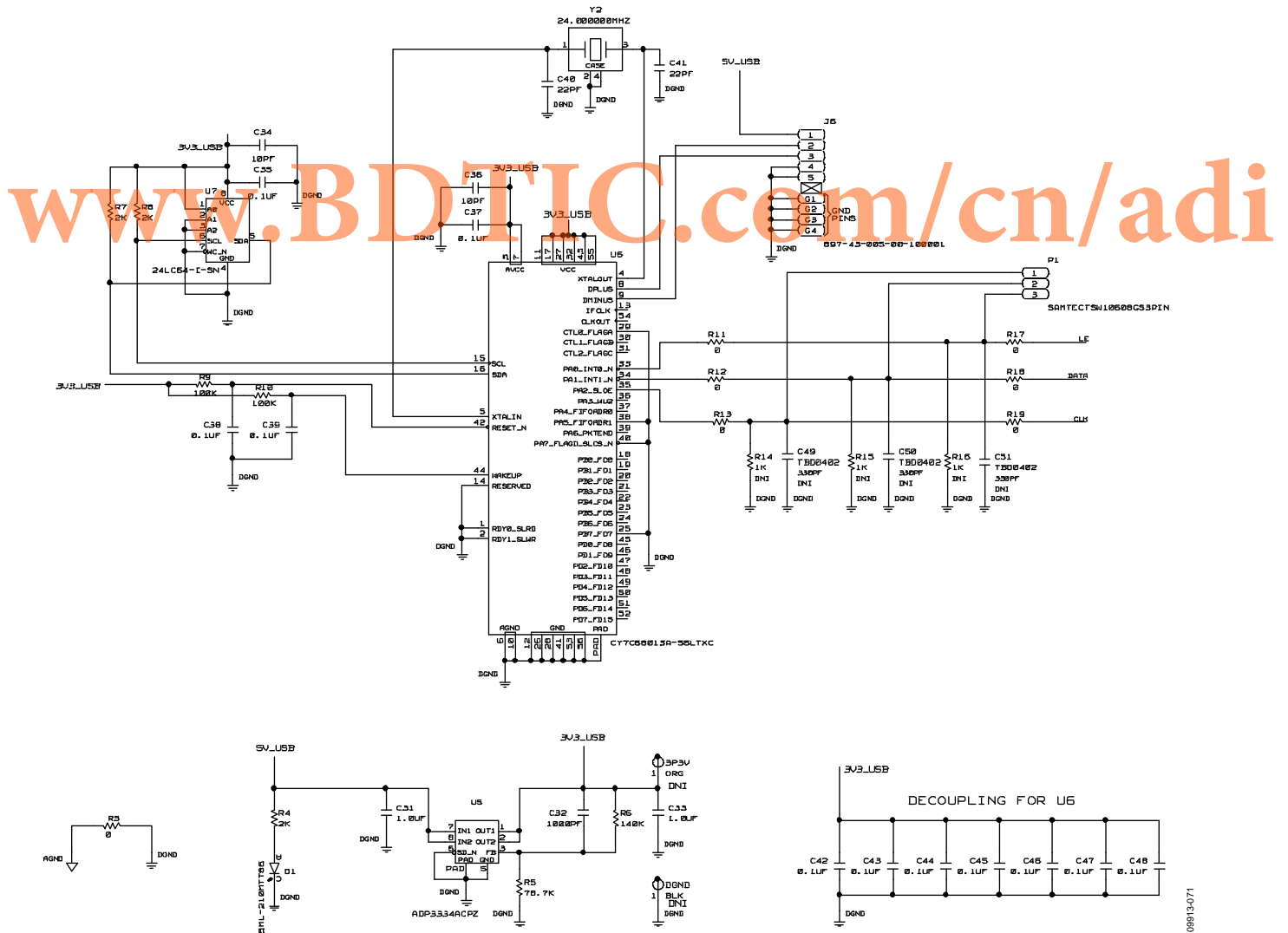
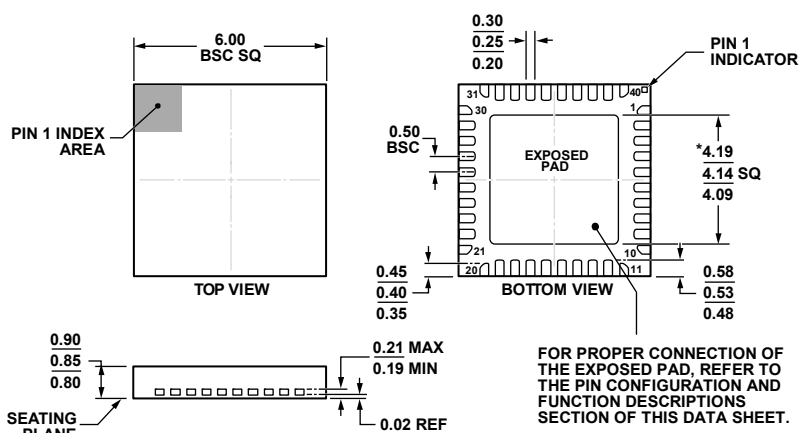

Figure 65. USB Interface Circuitry on the Evaluation Board

# OUTLINE DIMENSIONS



\*COMPLIANT TO JEDEC STANDARDS MO-208 EXCEPT FOR EXPOSED PAD DIMENSION

Figure 66. 40-Lead Lead Frame Chip Scale Package [LFCSP\_VQ]  
6 mm x 6 mm Body, Very Thin Quad (CP-40-6)  
Dimensions shown in millimeters

04-24-2008-A

## ORDERING GUIDE

Model <sup>1</sup>	Temperature Range	Package Description	Package Option	Quantity
ADL5812ACPZ-R7	-40°C to +85°C	40-Lead Lead Frame Chip Scale Package [LFCSP_VQ]	CP-40-6	750
ADL5812-EVALZ		Evaluation Board		

<sup>1</sup> Z = RoHS Compliant Part.

**ADL5812**

**NOTES**

[www.BDTIC.com/cn/adi](http://www.BDTIC.com/cn/adi)