

## FEATURES

- **Slew Rate: 7V/ $\mu$ s Typ**
- **Gain-Bandwidth Product: 14MHz Typ**
- Fast Settling to 0.01%
  - 2V Step to 200 $\mu$ V: 900ns Typ
  - 10V Step to 1mV: 2.2 $\mu$ s Typ
- Excellent DC Precision in All Packages
  - Input Offset Voltage: 275 $\mu$ V Max
  - Input Offset Voltage Drift: 6 $\mu$ V/ $^{\circ}$ C Max
  - Input Offset Current: 30nA Max
  - Input Bias Current: 125nA Max
  - Open-Loop Gain: 1200V/mV Min
- Single Supply Operation
  - Input Voltage Range Includes Ground
  - Output Swings to Ground While Sinking Current
- Low Input Noise Voltage: 12nV/ $\sqrt{\text{Hz}}$  Typ
- Low Input Noise Current: 0.2pA/ $\sqrt{\text{Hz}}$  Typ
- Specified on 3.3V, 5V and  $\pm$ 15V
- Large Output Drive Current: 20mA Min
- Low Supply Current per Amplifier: 1.8mA Max
- Dual in 8-Pin DIP and SO-8
- Quad in 14-Pin DIP and Narrow SO-16

**Note:** For applications requiring higher slew rate, see the LT1213/LT1214 and LT1215/LT1216 data sheets.

 LTC and LT are registered trademarks of Linear Technology Corporation.

## DESCRIPTION

The LT<sup>®</sup>1211 is a dual, single supply precision op amp with a 14MHz gain-bandwidth product and a 7V/ $\mu$ s slew rate. The LT1212 is a quad version of the same amplifier. The DC precision of the LT1211/LT1212 eliminates trims in most systems while providing high frequency performance not usually found in single supply amplifiers.

The LT1211/LT1212 will operate on any supply greater than 2.5V and less than 36V total. These amplifiers are specified on single 3.3V, single 5V and  $\pm$ 15V supplies, and only require 1.3mA of quiescent supply current per amplifier. The inputs can be driven beyond the supplies without damage or phase reversal of the output. The minimum output drive is 20mA, ideal for driving low impedance loads.

## APPLICATIONS

- 2.5V Full-Scale 12-Bit Systems:  $V_{OS} \leq 0.45\text{LSB}$
- 10V Full-Scale 16-Bit Systems:  $V_{OS} \leq 1.8\text{LSB}$
- Active Filters
- Photo Diode Amplifiers
- DAC Current-to-Voltage Amplifiers
- Battery-Powered Systems

## TYPICAL APPLICATION

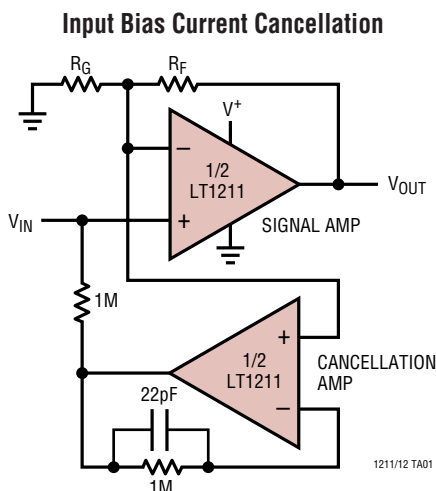

# LT1211/LT1212

## ABSOLUTE MAXIMUM RATINGS (Note 1)

|   |  |  |  |
|---|--|--|--|
| Total Supply Voltage ( $V^+$ to $V^-$ ) ..... | 36V  | Specified Temperature Range                    |  |
| Input Current .....                           | $\pm 15\text{mA}$                          | LT1211C/LT1212C/                               |  |
| Output Short-Circuit Duration (Note 2) .....  | Continuous                                 | LT1211I/LT1212I (Note 6) .....                 | $-40^\circ\text{C}$ to $85^\circ\text{C}$  |
| Operating Temperature Range                   |  | LT1211M ( <b>OBSOLETE</b> ) .....              | $-55^\circ\text{C}$ to $125^\circ\text{C}$ |
| LT1211C/LT1212C .....                         | $-40^\circ\text{C}$ to $85^\circ\text{C}$  | Storage Temperature Range .....                | $-65^\circ\text{C}$ to $150^\circ\text{C}$ |
| LT1211I/LT1212I .....                         | $-40^\circ\text{C}$ to $85^\circ\text{C}$  | Junction Temperature (Note 3)                  |  |
| LT1211M ( <b>OBSOLETE</b> ) .....             | $-55^\circ\text{C}$ to $125^\circ\text{C}$ | Plastic Package (N8, S8, N, S) .....           | $150^\circ\text{C}$                        |
|   |  | Ceramic Package (J8) ( <b>OBSOLETE</b> ) ..... | $175^\circ\text{C}$                        |
|   |  | Lead Temperature (Soldering, 10 sec) .....     | $300^\circ\text{C}$                        |

## PACKAGE/ORDER INFORMATION

|   |  |   |  |
|---|--|---|--|
| <p>N8 PACKAGE<br/>8-LEAD PDIP<br/><math>T_{JMAX} = 150^\circ\text{C}</math>, <math>\theta_{JA} = 100^\circ\text{C/W}</math> (N)<br/>J8 PACKAGE<br/>8-LEAD CERDIP<br/><math>T_{JMAX} = 175^\circ\text{C}</math>, <math>\theta_{JA} = 100^\circ\text{C/W}</math> (J)<br/><b>OBSOLETE PACKAGE</b><br/>Consider the N8 Package for Alternate Source</p> | <p>ORDER PART NUMBER</p> <p>LT1211CN8<br/>LT1211ACN8<br/>LT1211IN8</p> <p>LT1211MJ8<br/>LT1211AMJ8</p> | <p>S8 PACKAGE<br/>8-LEAD PLASTIC SO<br/><math>T_{JMAX} = 150^\circ\text{C}</math>, <math>\theta_{JA} = 150^\circ\text{C/W}</math></p> | <p>ORDER PART NUMBER</p> <p>LT1211CS8<br/>LT1211IS8</p> <p>S8 PART MARKING</p> <p>1211<br/>1211I</p> |
| <p>N PACKAGE<br/>14-LEAD PDIP<br/><math>T_{JMAX} = 150^\circ\text{C}</math>, <math>\theta_{JA} = 70^\circ\text{C/W}</math></p>  | <p>ORDER PART NUMBER</p> <p>LT1212CN<br/>LT1212IN</p>  | <p>S PACKAGE<br/>16-LEAD PLASTIC SO<br/><math>T_{JMAX} = 150^\circ\text{C}</math>, <math>\theta_{JA} = 100^\circ\text{C/W}</math></p> | <p>ORDER PART NUMBER</p> <p>LT1212CS<br/>LT1212IS</p>  |

Consult LTC Marketing for parts specified with wider operating temperature ranges.

## AVAILABLE OPTIONS

| NUMBER OF OP AMPS | $T_A$ RANGE                               | MAX $V_{OS}$ (25°C) | MAX TC $V_{OS}$ ( $\Delta V_{OS}/\Delta T$ ) | PACKAGE                 |                         |                         |
|-------------------|---|---------------------|--|-------------------------|-------------------------|-------------------------|
|                   |   |                     |  | CERAMIC (J)<br>OBSOLETE | PLASTIC DIP (N)         | SURFACE MOUNT (S)       |
| Two (Dual)        | $-40^\circ\text{C}$ to $85^\circ\text{C}$ | 150 $\mu\text{V}$   | 1.5 $\mu\text{V}/^\circ\text{C}$             |                         | LT1211ACN8              |                         |
|                   |   | 275 $\mu\text{V}$   | 3 $\mu\text{V}/^\circ\text{C}$               |                         | LT1211CN8,<br>LT1211IN8 |                         |
|                   |   | 275 $\mu\text{V}$   | 6 $\mu\text{V}/^\circ\text{C}$               |                         |                         | LT1211CS8,<br>LT1211IS8 |

## AVAILABLE OPTIONS

| NUMBER OF OP AMPS | T <sub>A</sub> RANGE | MAX V <sub>OS</sub> (25°C) | MAX TC V <sub>OS</sub> (ΔV <sub>OS</sub> /ΔT) | PACKAGE                 |                       |                       |
|-------------------|----------------------|----------------------------|---|-------------------------|-----------------------|-----------------------|
|                   |                      |                            |   | CERAMIC (J)<br>OBSOLETE | PLASTIC DIP (N)       | SURFACE MOUNT (S)     |
| Two (Dual)        | -55°C to 125°C       | 150μV                      | 1.5μV/°C                                      | LT1211AMJ8              |                       |                       |
|                   |                      | 275μV                      | 3μV/°C  | LT1211MJ8               |                       |                       |
| Four (Quad)       | -40°C to 85°C        | 275μV                      | 6μV/°C  |                         | LT1212CN,<br>LT1212IN | LT1212CS,<br>LT1212IS |

## 5V ELECTRICAL CHARACTERISTICS

V<sub>S</sub> = 5V, V<sub>CM</sub> = 0.5V, V<sub>OUT</sub> = 0.5V, T<sub>A</sub> = 25°C, unless otherwise noted.

| SYMBOL                              | PARAMETER                                | CONDITIONS   | LT1211AC<br>LT1211AM |              |       | LT1211C/LT1211M<br>LT1212C |              |       | UNITS             |   |
|-------------------------------------|--|--|----------------------|--------------|-------|----------------------------|--------------|-------|-------------------|---|
|                                     |  |  | MIN                  | TYP          | MAX   | MIN                        | TYP          | MAX   |                   |   |
| V <sub>OS</sub>                     | Input Offset Voltage                     |  |                      | 75           | 150   |                            | 100          | 275   | μV                |   |
| $\frac{\Delta V_{OS}}{\Delta Time}$ | Long-Term Input Offset Voltage Stability |  |                      | 0.5          |       |                            | 0.6          |       | μV/Mo             |   |
| I <sub>OS</sub>                     | Input Offset Current                     |  |                      | 5            | 20    |                            | 5            | 30    | nA                |   |
| I <sub>B</sub>                      | Input Bias Current                       |  |                      | 50           | 100   |                            | 60           | 125   | nA                |   |
| e <sub>n</sub>                      | Input Noise Voltage                      | 0.1Hz to 10Hz  |                      | 250          |       |                            | 250          |       | nV <sub>P-P</sub> |   |
|                                     | Input Noise Voltage Density              | f <sub>0</sub> = 10Hz<br>f <sub>0</sub> = 1000Hz                       |                      | 12.5<br>12.0 |       |                            | 12.5<br>12.0 |       | nV/√Hz<br>nV/√Hz  |   |
| i <sub>n</sub>                      | Input Noise Current Density              | f <sub>0</sub> = 10Hz<br>f <sub>0</sub> = 1000Hz                       |                      | 0.9<br>0.2   |       |                            | 0.9<br>0.2   |       | pA/√Hz<br>pA/√Hz  |   |
|                                     | Input Resistance (Note 4)                | Differential Mode<br>Common Mode                                       | 10                   | 40<br>500    |       | 10                         | 40<br>500    |       | MΩ<br>MΩ          |   |
|                                     | Input Capacitance                        | f = 1MHz   |                      | 10           |       |                            | 10           |       | pF                |   |
|                                     | Input Voltage Range                      |  | 3.5<br>0             | 3.8<br>-0.3  |       | 3.5<br>0                   | 3.8<br>-0.3  |       | V<br>V            |   |
| CMRR                                | Common Mode Rejection Ratio              | V <sub>CM</sub> = 0V to 3.5V   | 90                   | 105          |       | 86                         | 102          |       | dB                |   |
| PSRR                                | Power Supply Rejection Ratio             | V <sub>S</sub> = 2.5V to 12.5V   | 90                   | 115          |       | 87                         | 110          |       | dB                |   |
| A <sub>VOL</sub>                    | Large-Signal Voltage Gain                | V <sub>O</sub> = 0.05V to 3.7V, R <sub>L</sub> = 500Ω                  | 250                  | 560          |       | 250                        | 560          |       | V/mV              |   |
|                                     | Maximum Output Voltage Swing (Note 5)    | Output High, No Load   | 4.30                 | 4.40         |       | 4.30                       | 4.40         |       | V                 |   |
|                                     |  | Output High, I <sub>SOURCE</sub> = 1mA                                 | 4.20                 | 4.30         |       | 4.20                       | 4.30         |       | V                 |   |
|                                     |  | Output High, I <sub>SOURCE</sub> = 15mA                                | 3.85                 | 4.00         |       | 3.85                       | 4.00         |       | V                 |   |
|                                     |  | Output Low, No Load  |                      | 0.003        | 0.006 |                            | 0.003        | 0.006 |                   | V |
|                                     |  | Output Low, I <sub>SINK</sub> = 1mA                                    |                      | 0.047        | 0.065 |                            | 0.047        | 0.065 |                   | V |
|                                     |  | Output Low, I <sub>SINK</sub> = 15mA                                   |                      | 0.362        | 0.500 |                            | 0.362        | 0.500 |                   | V |
| I <sub>O</sub>                      | Maximum Output Current                   | (Note 10)  | ±20                  | ±50          |       | ±20                        | ±50          |       | mA                |   |
| SR                                  | Slew Rate                                | A <sub>V</sub> = -2  |                      | 4            |       |                            | 4            |       | V/μs              |   |
| GBW                                 | Gain-Bandwidth Product                   | f = 100kHz   |                      | 13           |       |                            | 13           |       | MHz               |   |
| I <sub>S</sub>                      | Supply Current per Amplifier             |  | 0.9                  | 1.3          | 1.8   | 0.9                        | 1.3          | 1.8   | mA                |   |
|                                     | Minimum Supply Voltage                   | Single Supply  |                      | 2.2          | 2.5   |                            | 2.2          | 2.5   | V                 |   |
|                                     | Full Power Bandwidth                     | A <sub>V</sub> = 1, V <sub>O</sub> = 2.5V <sub>P-P</sub>               |                      | 300          |       |                            | 300          |       | kHz               |   |
| t <sub>r</sub> , t <sub>f</sub>     | Rise Time, Fall Time                     | A <sub>V</sub> = 1, 10% to 90%, V <sub>O</sub> = 100mV                 |                      | 45           |       |                            | 45           |       | ns                |   |
| OS                                  | Overshoot                                | A <sub>V</sub> = 1, V <sub>O</sub> = 100mV                             |                      | 25           |       |                            | 25           |       | %                 |   |
| t <sub>PD</sub>                     | Propagation Delay                        | A <sub>V</sub> = 1, V <sub>O</sub> = 100mV                             |                      | 36           |       |                            | 36           |       | ns                |   |
| t <sub>S</sub>                      | Settling Time                            | 0.01%, A <sub>V</sub> = 1, ΔV <sub>O</sub> = 2V                        |                      | 900          |       |                            | 900          |       | ns                |   |
|                                     | Open-Loop Output Resistance              | I <sub>O</sub> = 0mA, f = 5MHz   |                      | 75           |       |                            | 75           |       | Ω                 |   |
| THD                                 | Total Harmonic Distortion                | A <sub>V</sub> = 1, V <sub>O</sub> = 1V <sub>RMS</sub> , 20Hz to 20kHz |                      | 0.001        |       |                            | 0.001        |       | %                 |   |

## 5V ELECTRICAL CHARACTERISTICS

$V_S = 5V$ ,  $V_{CM} = 0.5V$ ,  $V_{OUT} = 0.5V$ ,  $0^\circ C \leq T_A \leq 70^\circ C$ , unless otherwise noted.

| SYMBOL                           | PARAMETER                             | CONDITIONS                                    | LT1211AC |       |       | LT1211C/LT1212C |       |       | UNITS            |
|----------------------------------|---------------------------------------|---|----------|-------|-------|-----------------|-------|-------|------------------|
|                                  |                                       |   | MIN      | TYP   | MAX   | MIN             | TYP   | MAX   |                  |
| $V_{OS}$                         | Input Offset Voltage                  |   |          | 100   | 175   |                 | 150   | 375   | $\mu V$          |
| $\frac{\Delta V_{OS}}{\Delta T}$ | Input Offset Voltage Drift (Note 4)   | 8-Pin DIP Package<br>14-Pin DIP, SOIC Package |          | 0.7   | 1.5   |                 | 1     | 3     | $\mu V/^\circ C$ |
| $I_{OS}$                         | Input Offset Current                  |   |          | 5     | 25    |                 | 10    | 35    | nA               |
| $I_B$                            | Input Bias Current                    |   |          | 60    | 110   |                 | 70    | 135   | nA               |
|                                  | Input Voltage Range                   |   | 3.4      | 3.5   |       | 3.4             | 3.5   |       | V                |
|                                  |                                       |   | 0.1      | -0.1  |       | 0.1             | -0.1  |       | V                |
| CMRR                             | Common Mode Rejection Ratio           | $V_{CM} = 0.1V$ to $3.4V$                     | 89       | 105   |       | 85              | 102   |       | dB               |
| PSRR                             | Power Supply Rejection Ratio          | $V_S = 2.5V$ to $12.5V$                       | 89       | 114   |       | 86              | 110   |       | dB               |
| $A_{VOL}$                        | Large-Signal Voltage Gain             | $V_O = 0.05V$ to $3.7V$ , $R_L = 500\Omega$   | 150      | 430   |       | 150             | 430   |       | V/mV             |
|                                  | Maximum Output Voltage Swing (Note 5) | Output High, No Load                          | 4.20     | 4.33  |       | 4.20            | 4.33  |       | V                |
|                                  |                                       | Output High, $I_{SOURCE} = 1mA$               | 4.10     | 4.23  |       | 4.10            | 4.23  |       | V                |
|                                  |                                       | Output High, $I_{SOURCE} = 10mA$              | 3.90     | 4.03  |       | 3.90            | 4.03  |       | V                |
|                                  |                                       | Output Low, No Load                           |          | 0.004 | 0.007 |                 | 0.004 | 0.007 | V                |
|                                  |                                       | Output Low, $I_{SINK} = 1mA$                  |          | 0.052 | 0.070 |                 | 0.052 | 0.070 | V                |
|                                  |                                       | Output Low, $I_{SINK} = 10mA$                 |          | 0.290 | 0.400 |                 | 0.290 | 0.400 | V                |
| $I_S$                            | Supply Current per Amplifier          |   | 0.8      | 1.4   | 2.1   | 0.8             | 1.4   | 2.1   | mA               |

$V_S = 5V$ ,  $V_{CM} = 0.5V$ ,  $V_{OUT} = 0.5V$ ,  $-40^\circ C \leq T_A \leq 85^\circ C$ , unless otherwise noted. (Note 6)

| SYMBOL                           | PARAMETER                             | CONDITIONS                                    | LT1211AC |       |       | LT1211C/LT1212C<br>LT1211I/LT1212I |       |       | UNITS            |
|----------------------------------|---------------------------------------|---|----------|-------|-------|------------------------------------|-------|-------|------------------|
|                                  |                                       |   | MIN      | TYP   | MAX   | MIN                                | TYP   | MAX   |                  |
| $V_{OS}$                         | Input Offset Voltage                  |   |          | 120   | 200   |                                    | 175   | 500   | $\mu V$          |
| $\frac{\Delta V_{OS}}{\Delta T}$ | Input Offset Voltage Drift (Note 4)   | 8-Pin DIP Package<br>14-Pin DIP, SOIC Package |          | 0.7   | 1.5   |                                    | 1     | 3     | $\mu V/^\circ C$ |
| $I_{OS}$                         | Input Offset Current                  |   |          | 10    | 30    |                                    | 20    | 50    | nA               |
| $I_B$                            | Input Bias Current                    |   |          | 70    | 120   |                                    | 80    | 145   | nA               |
|                                  | Input Voltage Range                   |   | 3.1      | 3.2   |       | 3.1                                | 3.2   |       | V                |
|                                  |                                       |   | 0.2      | 0     |       | 0.2                                | 0     |       | V                |
| CMRR                             | Common Mode Rejection Ratio           | $V_{CM} = 0.2V$ to $3.1V$                     | 88       | 104   |       | 84                                 | 101   |       | dB               |
| PSRR                             | Power Supply Rejection Ratio          | $V_S = 2.5V$ to $12.5V$                       | 88       | 113   |       | 85                                 | 109   |       | dB               |
| $A_{VOL}$                        | Large-Signal Voltage Gain             | $V_O = 0.05V$ to $3.7V$ , $R_L = 500\Omega$   | 100      | 390   |       | 100                                | 390   |       | V/mV             |
|                                  | Maximum Output Voltage Swing (Note 5) | Output High, No Load                          | 4.15     | 4.25  |       | 4.15                               | 4.25  |       | V                |
|                                  |                                       | Output High, $I_{SOURCE} = 1mA$               | 4.00     | 4.16  |       | 4.00                               | 4.16  |       | V                |
|                                  |                                       | Output High, $I_{SOURCE} = 10mA$              | 3.80     | 3.96  |       | 3.80                               | 3.96  |       | V                |
|                                  |                                       | Output Low, No Load                           |          | 0.005 | 0.008 |                                    | 0.005 | 0.008 | V                |
|                                  |                                       | Output Low, $I_{SINK} = 1mA$                  |          | 0.053 | 0.075 |                                    | 0.053 | 0.075 | V                |
|                                  |                                       | Output Low, $I_{SINK} = 10mA$                 |          | 0.300 | 0.420 |                                    | 0.300 | 0.420 | V                |
| $I_S$                            | Supply Current per Amplifier          |   | 0.7      | 1.5   | 2.2   | 0.7                                | 1.5   | 2.2   | mA               |

## 5V ELECTRICAL CHARACTERISTICS

$V_S = 5V$ ,  $V_{CM} = 0.5V$ ,  $V_{OUT} = 0.5V$ ,  $-55^\circ C \leq T_A \leq 125^\circ C$ , unless otherwise noted.

| SYMBOL                           | PARAMETER                             | CONDITIONS                                  | LT1211AM |       |       | LT1211M |       |       | UNITS            |    |
|----------------------------------|---------------------------------------|---|----------|-------|-------|---------|-------|-------|------------------|----|
|                                  |                                       |   | MIN      | TYP   | MAX   | MIN     | TYP   | MAX   |                  |    |
| $V_{OS}$                         | Input Offset Voltage                  |   |          | 140   | 250   |         | 200   | 500   | $\mu V$          |    |
| $\frac{\Delta V_{OS}}{\Delta T}$ | Input Offset Voltage Drift (Note 4)   |   |          | 0.7   | 1.5   |         | 1     | 3     | $\mu V/^\circ C$ |    |
| $I_{OS}$                         | Input Offset Current                  |   |          | 15    | 40    |         | 25    | 75    | nA               |    |
| $I_B$                            | Input Bias Current                    |   |          | 75    | 130   |         | 85    | 160   | nA               |    |
|                                  | Input Voltage Range                   |   | 3.1      | 3.2   |       | 3.1     | 3.2   |       | V                |    |
|                                  |                                       |   |          | 0.4   | 0.2   |         | 0.4   | 0.2   |                  | V  |
| CMRR                             | Common Mode Rejection Ratio           | $V_{CM} = 0.4V$ to $3.1V$                   | 87       | 104   |       | 81      | 101   |       | dB               |    |
| PSRR                             | Power Supply Rejection Ratio          | $V_S = 2.5V$ to $12.5V$                     | 87       | 113   |       | 84      | 109   |       | dB               |    |
| $A_{VOL}$                        | Large-Signal Voltage Gain             | $V_O = 0.05V$ to $3.7V$ , $R_L = 500\Omega$ | 100      | 250   |       | 100     | 250   |       | V/mV             |    |
|                                  | Maximum Output Voltage Swing (Note 5) | Output High, No Load                        | 4.10     | 4.20  |       | 4.10    | 4.20  |       | V                |    |
|                                  |                                       | Output High, $I_{SOURCE} = 1mA$             | 3.95     | 4.10  |       | 3.95    | 4.10  |       | V                |    |
|                                  |                                       | Output High, $I_{SOURCE} = 10mA$            | 3.70     | 3.90  |       | 3.70    | 3.90  |       | V                |    |
|                                  |                                       | Output Low, No Load                         |          | 0.007 | 0.010 |         | 0.007 | 0.010 |                  | mV |
|                                  |                                       | Output Low, $I_{SINK} = 1mA$                |          | 0.060 | 0.085 |         | 0.060 | 0.085 |                  | mV |
|                                  |                                       | Output Low, $I_{SINK} = 10mA$               |          | 0.350 | 0.500 |         | 0.350 | 0.500 |                  | mV |
| $I_S$                            | Supply Current per Amplifier          |   | 0.5      | 1.7   | 2.5   | 0.5     | 1.7   | 2.5   | mA               |    |

## $\pm 15V$ ELECTRICAL CHARACTERISTICS

$V_S = \pm 15V$ ,  $V_{CM} = 0V$ ,  $V_{OUT} = 0V$ ,  $T_A = 25^\circ C$ , unless otherwise noted.

| SYMBOL    | PARAMETER                    | CONDITIONS                            | LT1211AC<br>LT1211AM |           |           | LT1211C/LT1211M<br>LT1212C |           |           | UNITS      |
|-----------|------------------------------|---------------------------------------|----------------------|-----------|-----------|----------------------------|-----------|-----------|------------|
|           |                              |                                       | MIN                  | TYP       | MAX       | MIN                        | TYP       | MAX       |            |
| $V_{OS}$  | Input Offset Voltage         |                                       |                      | 125       | 400       |                            | 150       | 550       | $\mu V$    |
| $I_{OS}$  | Input Offset Current         |                                       |                      | 5         | 20        |                            | 5         | 30        | nA         |
| $I_B$     | Input Bias Current           |                                       |                      | 45        | 95        |                            | 50        | 120       | nA         |
|           | Input Voltage Range          |                                       | 13.5                 | 13.8      |           | 13.5                       | 13.8      |           | V          |
|           |                              |                                       |                      | -15.0     | -15.3     |                            | -15.0     | -15.3     |            |
| CMRR      | Common Mode Rejection Ratio  | $V_{CM} = -15V$ to $13.5V$            | 90                   | 105       |           | 86                         | 102       |           | dB         |
| PSRR      | Power Supply Rejection Ratio | $V_S = \pm 2V$ to $\pm 18V$           | 90                   | 113       |           | 87                         | 110       |           | dB         |
| $A_{VOL}$ | Large-Signal Voltage Gain    | $V_O = 0V$ to $\pm 10V$ , $R_L = 2k$  | 1200                 | 5000      |           | 1200                       | 5000      |           | V/mV       |
|           | Maximum Output Voltage Swing | Output High, $I_{SOURCE} = 15mA$      | 13.8                 | 14.0      |           | 13.8                       | 14.0      |           | V          |
|           |                              | Output Low, $I_{SINK} = 15mA$         | -14.4                | -14.6     |           | -14.4                      | -14.6     |           | V          |
| $I_O$     | Maximum Output Current       | (Note 10)                             | $\pm 20$             | $\pm 50$  |           | $\pm 20$                   | $\pm 50$  |           | mA         |
| SR        | Slew Rate                    | $A_V = -2$ (Note 7)                   | 5                    | 7         |           | 5                          | 7         |           | V/ $\mu s$ |
| GBW       | Gain-Bandwidth Product       | $f = 100kHz$                          | 8                    | 14        |           | 8                          | 14        |           | MHz        |
| $I_S$     | Supply Current per Amplifier |                                       | 0.9                  | 1.8       | 2.5       | 0.9                        | 1.8       | 2.5       | mA         |
|           | Channel Separation           | $V_O = \pm 10V$ , $R_L = 2k$          | 128                  | 140       |           | 128                        | 140       |           | dB         |
|           | Minimum Supply Voltage       | Equal Split Supplies                  |                      | $\pm 1.2$ | $\pm 2.0$ |                            | $\pm 1.2$ | $\pm 2.0$ | V          |
|           | Full Power Bandwidth         | $A_V = 1$ , $V_O = 20V_{P-P}$         |                      | 60        |           |                            | 60        |           | kHz        |
|           | Settling Time                | 0.01%, $A_V = 1$ , $\Delta V_O = 10V$ |                      | 2.2       |           |                            | 2.2       |           | $\mu s$    |

## ±15V ELECTRICAL CHARACTERISTICS

$V_S = \pm 15V$ ,  $V_{CM} = 0V$ ,  $V_{OUT} = 0V$ ,  $0^\circ C \leq T_A \leq 70^\circ C$ , unless otherwise noted.

| SYMBOL                           | PARAMETER                           | CONDITIONS                                    | LT1211AC |       |     | LT1211C/LT1212C |       |     | UNITS            |
|----------------------------------|-------------------------------------|---|----------|-------|-----|-----------------|-------|-----|------------------|
|                                  |                                     |   | MIN      | TYP   | MAX | MIN             | TYP   | MAX |                  |
| $V_{OS}$                         | Input Offset Voltage                |   |          | 150   | 425 |                 | 200   | 650 | $\mu V$          |
| $\frac{\Delta V_{OS}}{\Delta T}$ | Input Offset Voltage Drift (Note 4) | 8-Pin DIP Package<br>14-Pin DIP, SOIC Package |          | 0.7   | 1.5 |                 | 1     | 3   | $\mu V/^\circ C$ |
| $I_{OS}$                         | Input Offset Current                |   |          | 10    | 20  |                 | 10    | 35  | nA               |
| $I_B$                            | Input Bias Current                  |   |          | 55    | 100 |                 | 60    | 125 | nA               |
|                                  | Input Voltage Range                 |   | 13.4     | 13.5  |     | 13.4            | 13.5  |     | V                |
|                                  |                                     |   | -14.9    | -15.1 |     | -14.9           | -15.1 |     | V                |
| CMRR                             | Common Mode Rejection Ratio         | $V_{CM} = -14.9V$ to $13.4V$                  | 89       | 104   |     | 85              | 101   |     | dB               |
| PSRR                             | Power Supply Rejection Ratio        | $V_S = \pm 2V$ to $\pm 18V$                   | 89       | 112   |     | 86              | 108   |     | dB               |
| $A_{VOL}$                        | Large-Signal Voltage Gain           | $V_O = 0V$ to $\pm 10V$ , $R_L = 2k$          | 1000     | 3500  |     | 1000            | 3500  |     | V/mV             |
|                                  | Maximum Output Voltage Swing        | Output High, $I_{SOURCE} = 10mA$              | 13.8     | 14.0  |     | 13.8            | 14.0  |     | V                |
|                                  |                                     | Output Low, $I_{SINK} = 10mA$                 | -14.5    | -14.7 |     | -14.5           | -14.7 |     | V                |
| $I_S$                            | Supply Current per Amplifier        |   | 0.8      | 2.1   | 2.9 | 0.8             | 2.1   | 2.9 | mA               |

$V_S = \pm 15V$ ,  $V_{CM} = 0V$ ,  $V_{OUT} = 0V$ ,  $-40^\circ C \leq T_A \leq 85^\circ C$ , unless otherwise noted. (Note 6)

| SYMBOL                           | PARAMETER                           | CONDITIONS                                    | LT1211AC |       |     | LT1211C/LT1212C<br>LT1211I/LT1212I |       |     | UNITS            |
|----------------------------------|-------------------------------------|---|----------|-------|-----|------------------------------------|-------|-----|------------------|
|                                  |                                     |   | MIN      | TYP   | MAX | MIN                                | TYP   | MAX |                  |
| $V_{OS}$                         | Input Offset Voltage                |   |          | 175   | 450 |                                    | 250   | 700 | $\mu V$          |
| $\frac{\Delta V_{OS}}{\Delta T}$ | Input Offset Voltage Drift (Note 4) | 8-Pin DIP Package<br>14-Pin DIP, SOIC Package |          | 0.7   | 1.5 |                                    | 1     | 3   | $\mu V/^\circ C$ |
| $I_{OS}$                         | Input Offset Current                |   |          | 10    | 25  |                                    | 10    | 40  | nA               |
| $I_B$                            | Input Bias Current                  |   |          | 55    | 100 |                                    | 60    | 130 | nA               |
|                                  | Input Voltage Range                 |   | 13.1     | 13.2  |     | 13.1                               | 13.2  |     | V                |
|                                  |                                     |   | -14.8    | -15.0 |     | -14.8                              | -15.0 |     | V                |
| CMRR                             | Common Mode Rejection Ratio         | $V_{CM} = -14.8V$ to $13.1V$                  | 88       | 103   |     | 84                                 | 100   |     | dB               |
| PSRR                             | Power Supply Rejection Ratio        | $V_S = \pm 2V$ to $\pm 18V$                   | 88       | 111   |     | 85                                 | 107   |     | dB               |
| $A_{VOL}$                        | Large-Signal Voltage Gain           | $V_O = 0V$ to $\pm 10V$ , $R_L = 2k$          | 1000     | 3000  |     | 1000                               | 3000  |     | V/mV             |
|                                  | Maximum Output Voltage Swing        | Output High, $I_{SOURCE} = 10mA$              | 13.7     | 13.9  |     | 13.7                               | 13.9  |     | V                |
|                                  |                                     | Output Low, $I_{SINK} = 10mA$                 | -14.5    | -14.7 |     | -14.5                              | -14.7 |     | V                |
| $I_S$                            | Supply Current per Amplifier        |   | 0.7      | 2.2   | 3.0 | 0.7                                | 2.2   | 3.0 | mA               |

$V_S = \pm 15V$ ,  $V_{CM} = 0V$ ,  $V_{OUT} = 0V$ ,  $-55^\circ C \leq T_A \leq 125^\circ C$ , unless otherwise noted.

| SYMBOL                           | PARAMETER                           | CONDITIONS                           | LT1211AM |       |     | LT1211M |       |     | UNITS            |
|----------------------------------|-------------------------------------|--------------------------------------|----------|-------|-----|---------|-------|-----|------------------|
|                                  |                                     |                                      | MIN      | TYP   | MAX | MIN     | TYP   | MAX |                  |
| $V_{OS}$                         | Input Offset Voltage                |                                      |          | 200   | 500 |         | 300   | 800 | $\mu V$          |
| $\frac{\Delta V_{OS}}{\Delta T}$ | Input Offset Voltage Drift (Note 4) |                                      |          | 0.7   | 1.5 |         | 1     | 3   | $\mu V/^\circ C$ |
| $I_{OS}$                         | Input Offset Current                |                                      |          | 10    | 40  |         | 10    | 60  | nA               |
| $I_B$                            | Input Bias Current                  |                                      |          | 55    | 110 |         | 60    | 140 | nA               |
|                                  | Input Voltage Range                 |                                      | 13.1     | 13.2  |     | 13.1    | 13.2  |     | V                |
|                                  |                                     |                                      | -14.6    | -14.8 |     | -14.6   | -14.8 |     | V                |
| CMRR                             | Common Mode Rejection Ratio         | $V_{CM} = -14.6V$ to $13.1V$         | 87       | 103   |     | 81      | 100   |     | dB               |
| PSRR                             | Power Supply Rejection Ratio        | $V_S = \pm 2V$ to $\pm 15V$          | 87       | 111   |     | 84      | 107   |     | dB               |
| $A_{VOL}$                        | Large-Signal Voltage Gain           | $V_O = 0V$ to $\pm 10V$ , $R_L = 2k$ | 800      | 1500  |     | 800     | 1500  |     | V/mV             |
|                                  | Maximum Output Voltage Swing        | Output High, $I_{SOURCE} = 10mA$     | 13.6     | 13.8  |     | 13.6    | 13.8  |     | V                |
|                                  |                                     | Output Low, $I_{SINK} = 10mA$        | -14.3    | -14.5 |     | -14.3   | -14.5 |     | V                |
| $I_S$                            | Supply Current per Amplifier        |                                      | 0.5      | 2.3   | 3.4 | 0.5     | 2.3   | 3.4 | mA               |

### 3.3V ELECTRICAL CHARACTERISTICS

$V_S = 3.3V$ ,  $V_{CM} = 0.5V$ ,  $V_{OUT} = 0.5V$ ,  $T_A = 25^\circ C$ , unless otherwise noted. (Note 8)

| SYMBOL   | PARAMETER                    | CONDITIONS                       | LT1211AC<br>LT1211AM |          |       | LT1211C/LT1211M<br>LT1212C |          |       | UNITS   |
|----------|------------------------------|----------------------------------|----------------------|----------|-------|----------------------------|----------|-------|---------|
|          |                              |                                  | MIN                  | TYP      | MAX   | MIN                        | TYP      | MAX   |         |
| $V_{OS}$ | Input Offset Voltage         |                                  |                      | 75       | 150   |                            | 100      | 275   | $\mu V$ |
|          | Input Voltage Range (Note 9) |                                  | 1.8                  | 2.1      |       | 1.8                        | 2.1      |       | V       |
|          |                              |                                  | 0                    | -0.3     |       | 0                          | -0.3     |       | V       |
|          | Maximum Output Voltage Swing | Output High, No Load             | 2.60                 | 2.70     |       | 2.60                       | 2.70     |       | V       |
|          |                              | Output High, $I_{SOURCE} = 1mA$  | 2.50                 | 2.60     |       | 2.50                       | 2.60     |       | V       |
|          |                              | Output High, $I_{SOURCE} = 15mA$ | 2.15                 | 2.30     |       | 2.15                       | 2.30     |       | V       |
|          |                              | Output Low, No Load              |                      | 0.003    | 0.006 |                            | 0.003    | 0.006 | V       |
|          |                              | Output Low, $I_{SINK} = 1mA$     |                      | 0.047    | 0.065 |                            | 0.047    | 0.065 | V       |
|          |                              | Output Low, $I_{SINK} = 15mA$    |                      | 0.362    | 0.500 |                            | 0.362    | 0.500 | V       |
| $I_O$    | Maximum Output Current       |                                  | $\pm 20$             | $\pm 50$ |       | $\pm 20$                   | $\pm 50$ | mA    |         |

$V_S = 3.3V$ ,  $V_{CM} = 0.5V$ ,  $V_{OUT} = 0.5V$ ,  $0^\circ C \leq T_A \leq 70^\circ C$ , unless otherwise noted. (Note 8)

| SYMBOL   | PARAMETER                    | CONDITIONS                       | LT1211AC |       |       | LT1211C/LT1212C |       |       | UNITS   |
|----------|------------------------------|----------------------------------|----------|-------|-------|-----------------|-------|-------|---------|
|          |                              |                                  | MIN      | TYP   | MAX   | MIN             | TYP   | MAX   |         |
| $V_{OS}$ | Input Offset Voltage         |                                  |          | 100   | 175   |                 | 150   | 375   | $\mu V$ |
|          | Input Voltage Range (Note 9) |                                  | 1.7      | 1.4   |       | 1.7             | 1.8   |       | V       |
|          |                              |                                  | 0.1      | -0.1  |       | 0.1             | -0.1  |       | V       |
|          | Maximum Output Voltage Swing | Output High, No Load             | 2.50     | 2.63  |       | 2.50            | 2.63  |       | V       |
|          |                              | Output High, $I_{SOURCE} = 1mA$  | 2.40     | 2.53  |       | 2.40            | 2.53  |       | V       |
|          |                              | Output High, $I_{SOURCE} = 10mA$ | 2.20     | 2.33  |       | 2.20            | 2.33  |       | V       |
|          |                              | Output Low, No Load              |          | 0.004 | 0.007 |                 | 0.004 | 0.007 | V       |
|          |                              | Output Low, $I_{SINK} = 1mA$     |          | 0.052 | 0.070 |                 | 0.052 | 0.070 | V       |
|          |                              | Output Low, $I_{SINK} = 10mA$    |          | 0.290 | 0.400 |                 | 0.290 | 0.400 | V       |

$V_S = 3.3V$ ,  $V_{CM} = 0.5V$ ,  $V_{OUT} = 0.5V$ ,  $-40^\circ C \leq T_A \leq 85^\circ C$ , unless otherwise noted. (Notes 6, 8)

| SYMBOL   | PARAMETER                    | CONDITIONS                       | LT1211AC |       |       | LT1211C/LT1212C<br>LT1211I/LT1212I |       |       | UNITS   |
|----------|------------------------------|----------------------------------|----------|-------|-------|------------------------------------|-------|-------|---------|
|          |                              |                                  | MIN      | TYP   | MAX   | MIN                                | TYP   | MAX   |         |
| $V_{OS}$ | Input Offset Voltage         |                                  |          | 120   | 200   |                                    | 175   | 500   | $\mu V$ |
|          | Input Voltage Range (Note 9) |                                  | 1.4      | 1.5   |       | 1.4                                | 1.5   |       | V       |
|          |                              |                                  | 0.2      | 0     |       | 0.2                                | 0     |       | V       |
|          | Maximum Output Voltage Swing | Output High, No Load             | 2.45     | 2.55  |       | 2.45                               | 2.55  |       | V       |
|          |                              | Output High, $I_{SOURCE} = 1mA$  | 2.30     | 2.46  |       | 2.30                               | 2.46  |       | V       |
|          |                              | Output High, $I_{SOURCE} = 10mA$ | 2.10     | 2.26  |       | 2.10                               | 2.26  |       | V       |
|          |                              | Output Low, No Load              |          | 0.005 | 0.008 |                                    | 0.005 | 0.008 | V       |
|          |                              | Output Low, $I_{SINK} = 1mA$     |          | 0.053 | 0.075 |                                    | 0.053 | 0.075 | V       |
|          |                              | Output Low, $I_{SINK} = 10mA$    |          | 0.300 | 0.420 |                                    | 0.300 | 0.420 | V       |

$V_S = 3.3V$ ,  $V_{CM} = 0.5V$ ,  $V_{OUT} = 0.5V$ ,  $-55^\circ C \leq T_A \leq 125^\circ C$ , unless otherwise noted. (Note 8)

| SYMBOL   | PARAMETER                    | CONDITIONS                       | LT1211AM |       |       | LT1211M |       |       | UNITS   |
|----------|------------------------------|----------------------------------|----------|-------|-------|---------|-------|-------|---------|
|          |                              |                                  | MIN      | TYP   | MAX   | MIN     | TYP   | MAX   |         |
| $V_{OS}$ | Input Offset Voltage         |                                  |          | 130   | 250   |         | 200   | 500   | $\mu V$ |
|          | Input Voltage Range (Note 9) |                                  | 1.4      | 1.5   |       | 1.4     | 1.5   |       | V       |
|          |                              |                                  | 0.4      | 0.2   |       | 0.4     | 0.2   |       | V       |
|          | Maximum Output Voltage Swing | Output High, No Load             | 2.40     | 2.50  |       | 2.40    | 2.50  |       | V       |
|          |                              | Output High, $I_{SOURCE} = 1mA$  | 2.25     | 2.40  |       | 2.25    | 2.40  |       | V       |
|          |                              | Output High, $I_{SOURCE} = 10mA$ | 2.00     | 2.20  |       | 2.00    | 2.20  |       | V       |
|          |                              | Output Low, No Load              |          | 0.007 | 0.010 |         | 0.007 | 0.010 | V       |
|          |                              | Output Low, $I_{SINK} = 1mA$     |          | 0.060 | 0.085 |         | 0.060 | 0.085 | V       |
|          |                              | Output Low, $I_{SINK} = 10mA$    |          | 0.350 | 0.500 |         | 0.350 | 0.500 | V       |

## ELECTRICAL CHARACTERISTICS

**Note 1:** Absolute Maximum Ratings are those values beyond which the life of a device may be impaired.

**Note 2:** A heat sink may be required to keep the junction temperature below absolute maximum when the output is shorted indefinitely.

**Note 3:**  $T_J$  is calculated from the ambient temperature  $T_A$  and power dissipation  $P_D$  according to the following formulas:

$$\begin{aligned} \text{LT1211MJ8, LT1211AMJ8: } T_J &= T_A + (P_D \times 100^\circ\text{C/W}) \\ \text{LT1211CN8, LT1211ACN8: } T_J &= T_A + (P_D \times 100^\circ\text{C/W}) \\ \text{LT1211CS8: } T_J &= T_A + (P_D \times 150^\circ\text{C/W}) \\ \text{LT1212CN: } T_J &= T_A + (P_D \times 70^\circ\text{C/W}) \\ \text{LT1212CS: } T_J &= T_A + (P_D \times 100^\circ\text{C/W}) \end{aligned}$$

**Note 4:** This parameter is not 100% tested.

**Note 5:** Guaranteed by correlation to 3.3V and  $\pm 15\text{V}$  tests.

**Note 6:** The LT1211C/LT1212C are guaranteed to meet specified performance from  $0^\circ\text{C}$  to  $70^\circ\text{C}$  and are designed, characterized and expected to meet these extended temperature limits, but are not tested at  $-40^\circ\text{C}$  and  $85^\circ\text{C}$ . The LT1211I/LT1212I are guaranteed to meet the extended temperature limits.

**Note 7:** Slew rate is measured between  $\pm 8.5\text{V}$  on an output swing of  $\pm 10\text{V}$  on  $\pm 15\text{V}$  supplies.

**Note 8:** Most LT1211/LT1212 electrical characteristics change very little with supply voltage. See the 5V tables for characteristics not listed in the 3.3V table.

**Note 9:** Guaranteed by correlation to 5V and  $\pm 15\text{V}$  tests.

**Note 10:** Guaranteed by correlation to 3.3V tests.

## TYPICAL PERFORMANCE CHARACTERISTICS

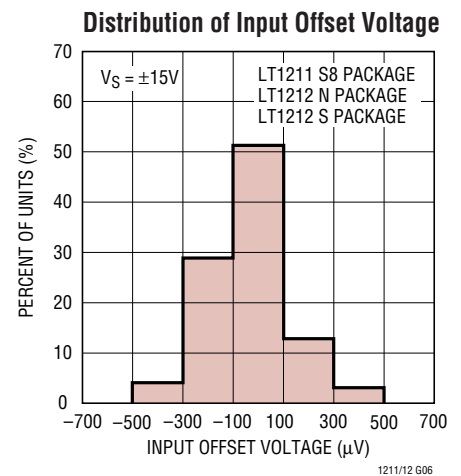
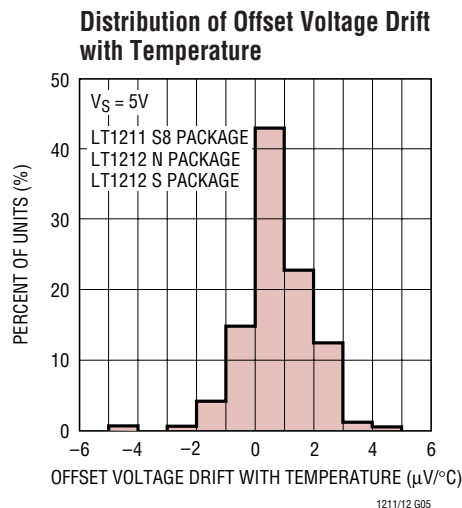
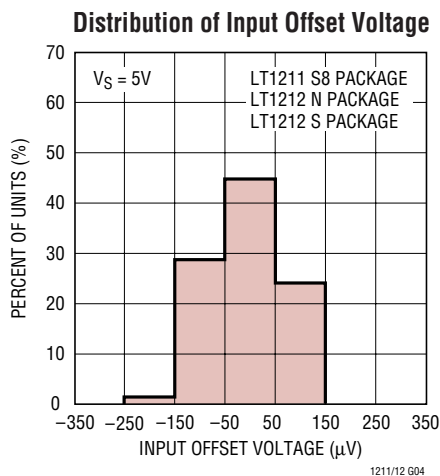
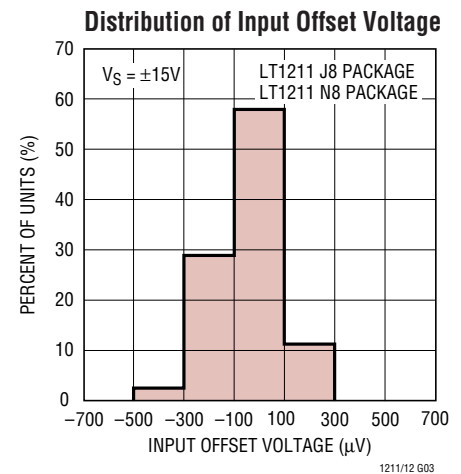
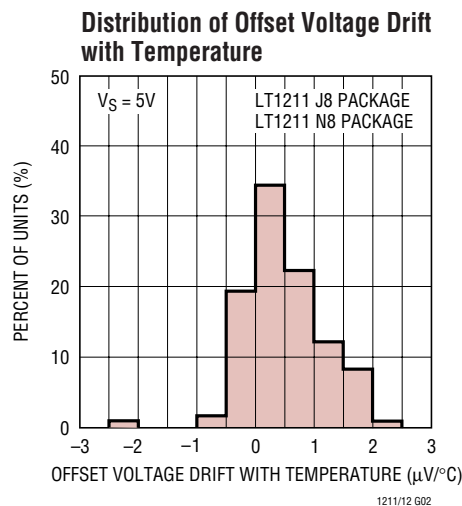
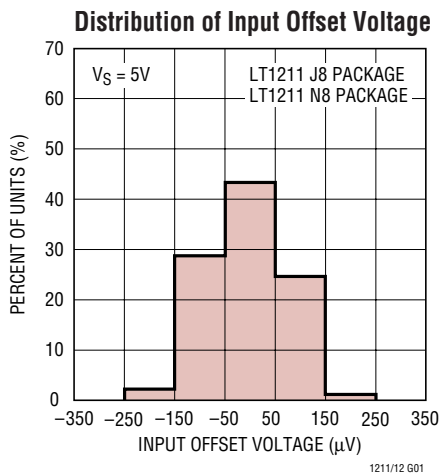



# TYPICAL PERFORMANCE CHARACTERISTICS

**Voltage Gain vs Frequency**

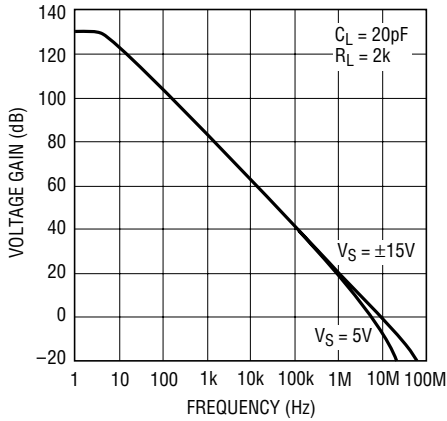

1211/12 G07

**Voltage Gain, Phase vs Frequency**

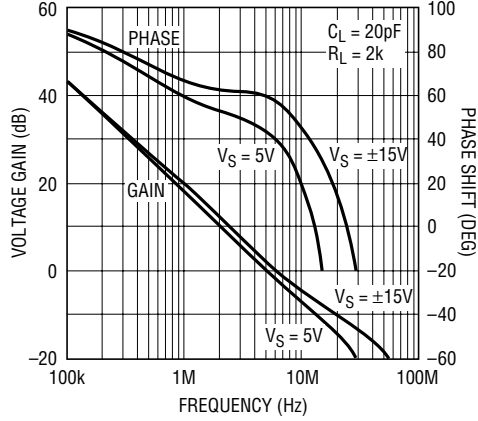

1211/12 G08

**Gain-Bandwidth Product, Phase Margin vs Supply Voltage**

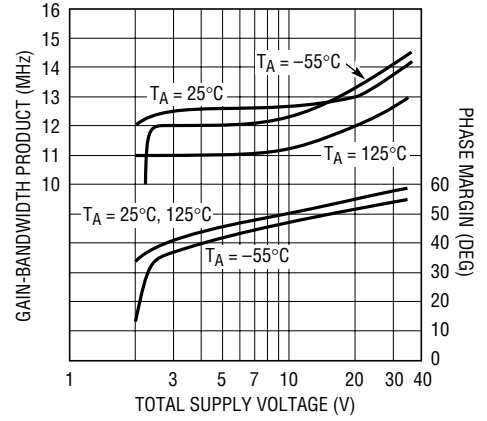

1211/12 G09

**Slew Rate vs Temperature**

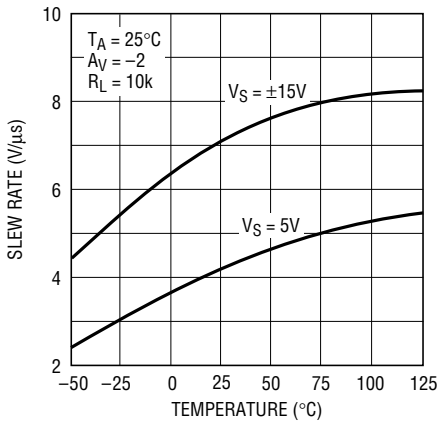

1211/12 G10

**Slew Rate vs Supply Voltage**

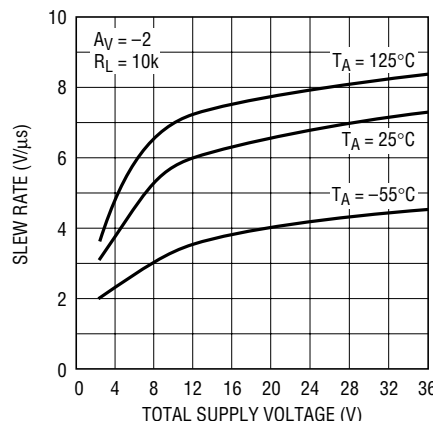

1211/12 G11

**Capacitive Load Handling**

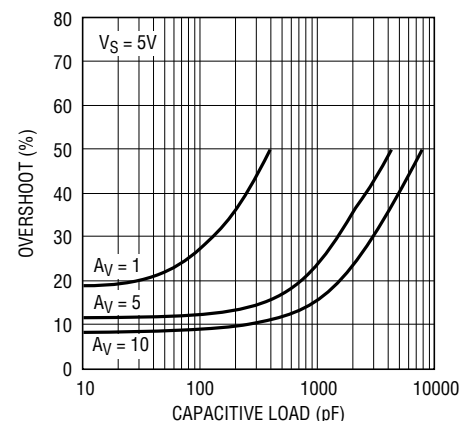

1211/12 G12

**Undistorted Output Swing vs Frequency, VS = 5V**

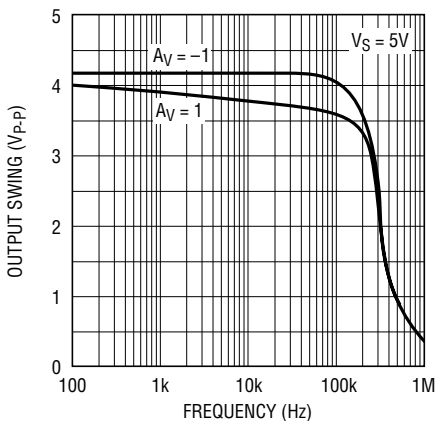

1211/12 G13

**Undistorted Output Swing vs Frequency, VS = ±15V**

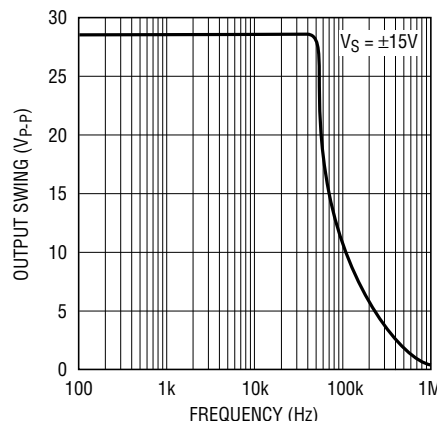

1211/12 G14

**Total Harmonic Distortion and Noise vs Frequency**

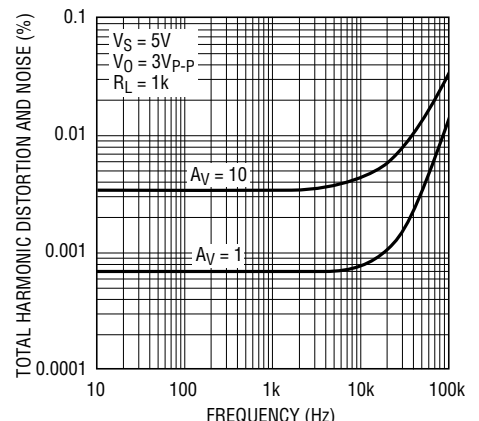

1211/12 G15

TYPICAL PERFORMANCE CHARACTERISTICS

Open-Loop Voltage Gain vs Supply Voltage

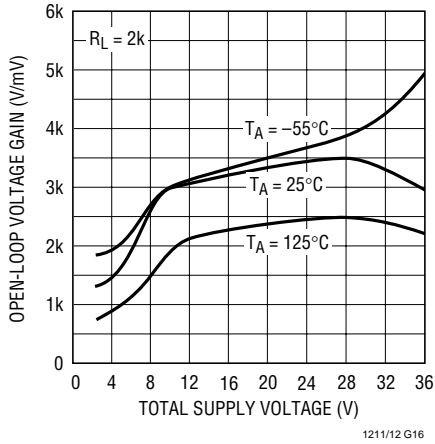

1211/12 G16

Open-Loop Gain, VS = 5V

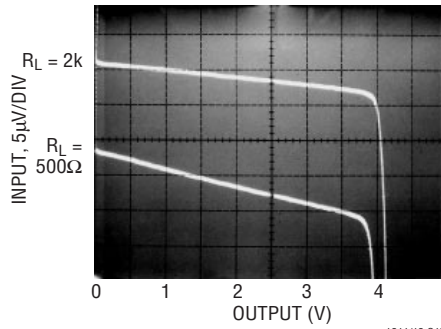

1211/12 G17

Positive Output Saturation Voltage vs Temperature

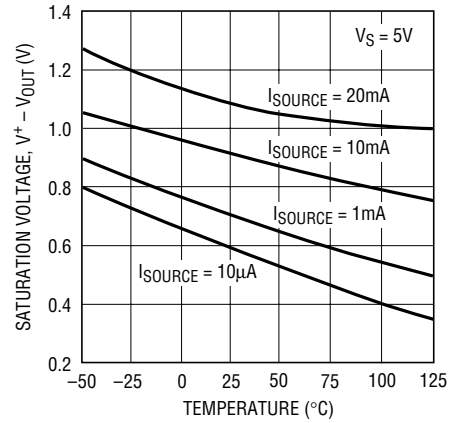

1211/12 G18

Voltage Gain vs Load Resistance

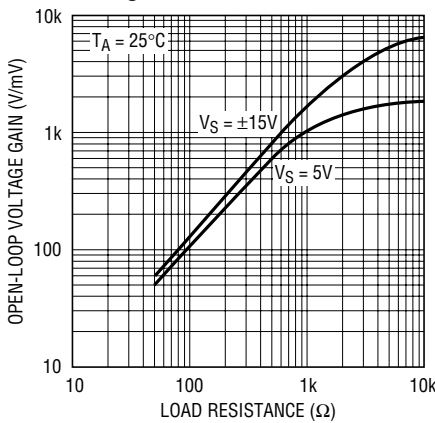

1211/12 G19

Open-Loop Gain, VS = ±15V

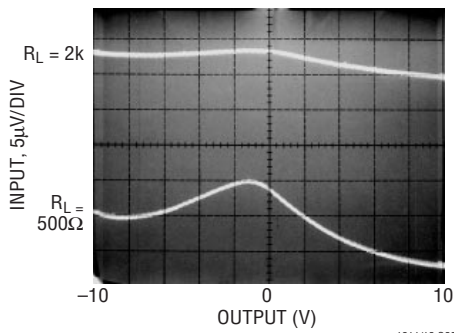

1211/12 G20

Negative Output Saturation Voltage vs Temperature

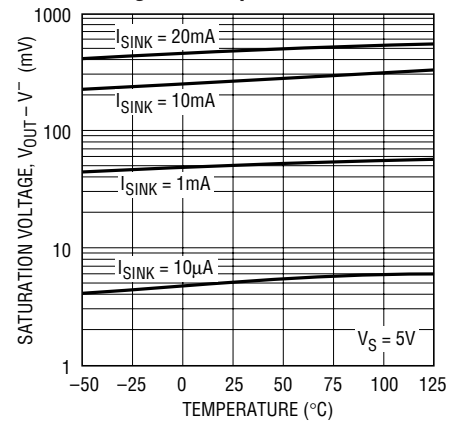

1211/12 G21

Channel Separation vs Frequency

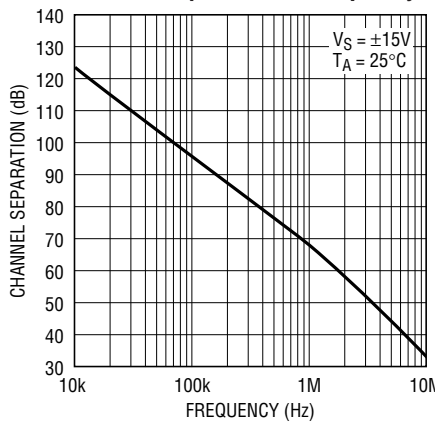

1211/12 G22

Output Short-Circuit Current vs Temperature

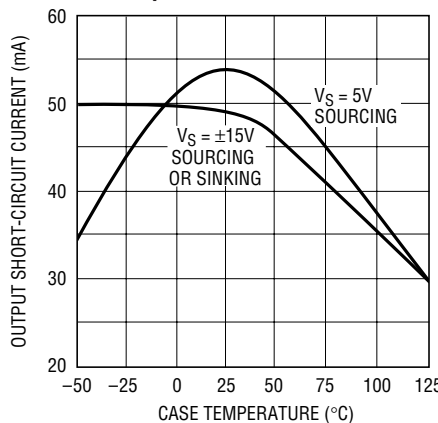

1211/12 G23

Output Impedance vs Frequency

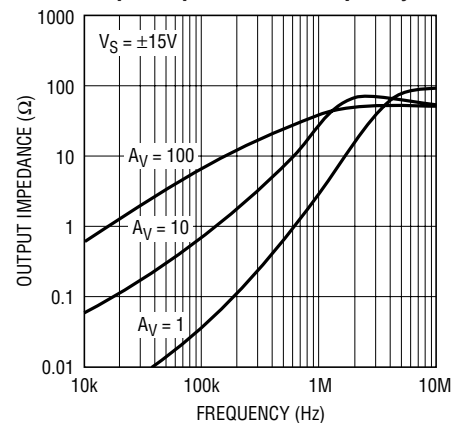

1211/12 G24

TYPICAL PERFORMANCE CHARACTERISTICS

5V Small-Signal Response



$V_S = 5V$   
 $A_V = 1$   
1211/12 G25

5V Large-Signal Response



$V_S = 5V$   
 $A_V = 1$   
1211/12 G26

5V Large-Signal Response

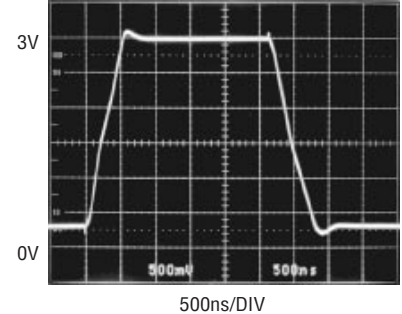

$V_S = 5V$   
 $A_V = -1$   
 $R_F = R_G = 1k$   
 $C_F = 20pF$   
1211/12 G27

±15V Small-Signal Response



$V_S = \pm 15V$   
 $A_V = 1$   
1211/12 G28

±15V Large-Signal Response



$V_S = \pm 15V$   
 $A_V = 1$   
1211/12 G29

±15V Large-Signal Response

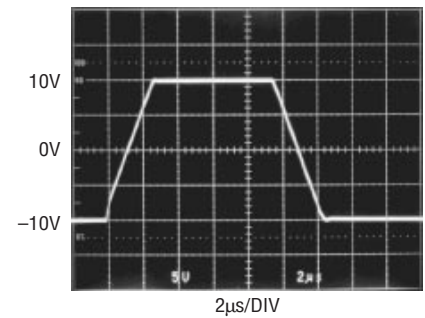

$V_S = \pm 15V$   
 $A_V = -1$   
 $R_F = R_G = 1k$   
1211/12 G30

5V Settling



$V_S = 5V$   
 $A_V = 1$   
1211/12 G31

±15V Settling



$V_S = \pm 15V$   
 $A_V = -1$   
1211/12 G32

Settling Time to 0.01% vs Output Step

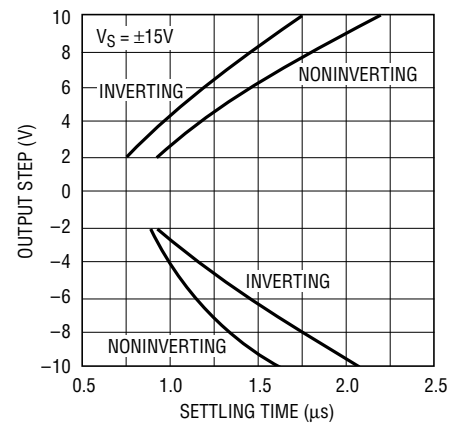

1211/12 G33

TYPICAL PERFORMANCE CHARACTERISTICS

Supply Current vs Supply Voltage

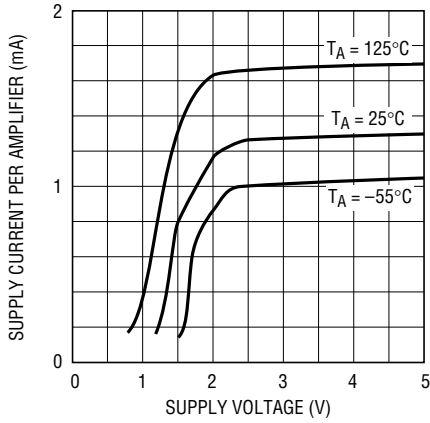

1211/12 G34

Supply Current vs Temperature

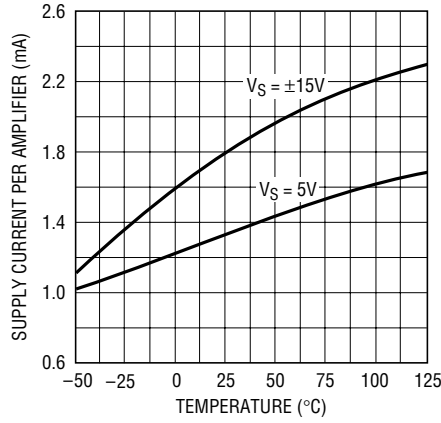

1211/12 G35

Warm-Up Drift vs Time

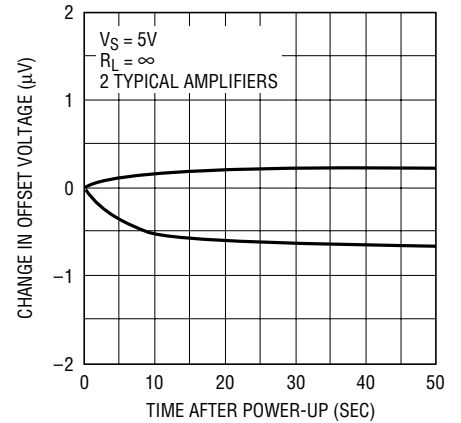

1211/12 G36

Input Bias Current vs Temperature

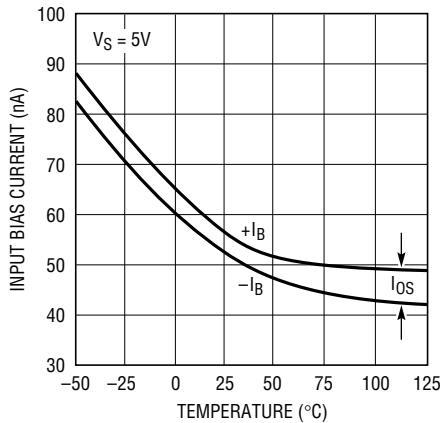

1211/12 G37

Input Bias Current vs Common Mode Voltage

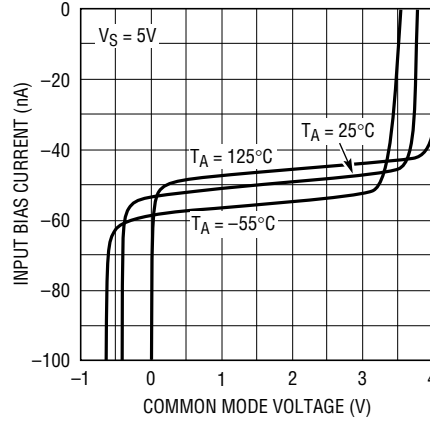

1211/12 G38

Common Mode Range vs Temperature

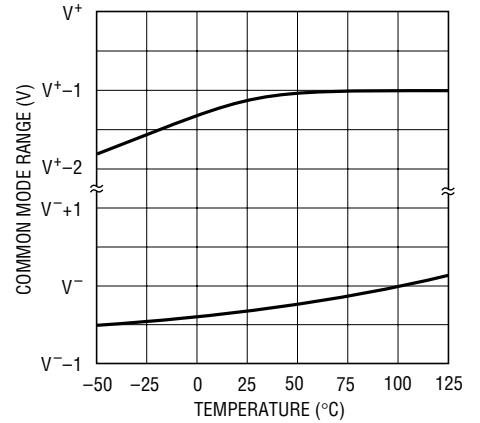

1211/12 G39

Input Noise Current, Noise Voltage Density vs Frequency

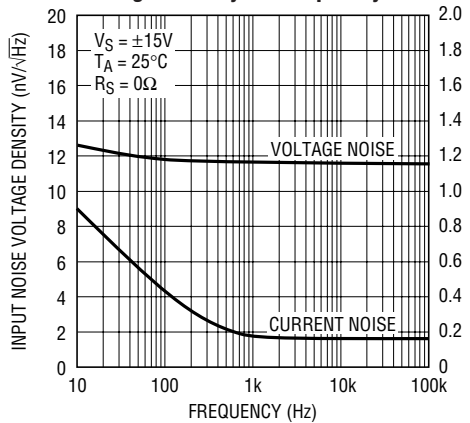

1211/12 G40

Common Mode Rejection Ratio vs Frequency

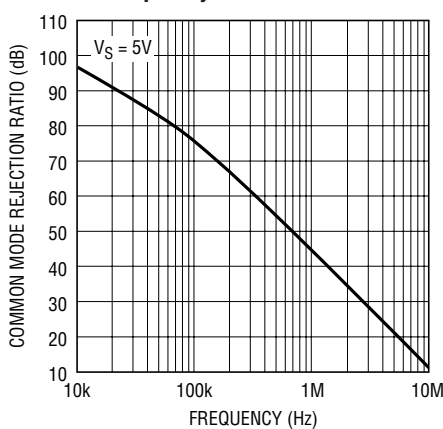

1211/12 G41

Input Referred Power Supply Rejection Ratio vs Frequency

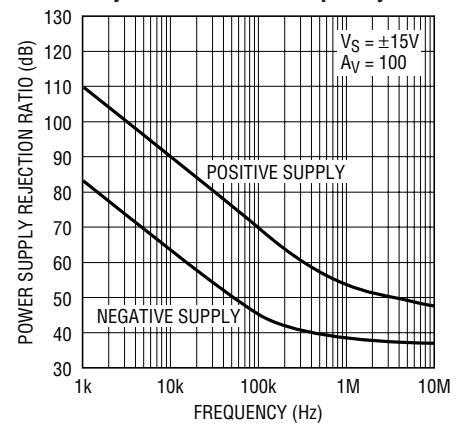

1211/12 G42

## APPLICATIONS INFORMATION

### Supply Voltage

The LT1211/LT1212 op amps are fully functional and all internal bias circuits are in regulation with 2.2V of supply. The amplifiers will continue to function with as little as 1.5V, although the input common-mode range and the phase margin are about gone. The minimum operating supply voltage is guaranteed by the PSRR tests which are done with the input common mode equal to 500mV and a minimum supply voltage of 2.5V. The LT1211/LT1212 are guaranteed over the full  $-55^{\circ}\text{C}$  to  $125^{\circ}\text{C}$  range with a minimum supply voltage of 2.5V.

The positive supply pin of the LT1211/LT1212 should be bypassed with a small capacitor (about  $0.01\mu\text{F}$ ) within an inch of the pin. When driving heavy loads and for good settling time, an additional  $4.7\mu\text{F}$  capacitor should be used. When using split supplies, the same is true for the negative supply pin.

### Power Dissipation

The LT1211/LT1212 amplifiers combine high speed and large output current drive into very small packages. Because these amplifiers work over a very wide supply range, it is possible to exceed the maximum junction temperature under certain conditions. To insure that the LT1211/LT1212 are used properly, calculate the worst case power dissipation, define the maximum ambient temperature, select the appropriate package and then calculate the maximum junction temperature.

The worst case amplifier power dissipation is the total of the quiescent current times the total power supply voltage plus the power in the IC due to the load. The quiescent supply current of the LT1211/LT1212 has a positive temperature coefficient. The maximum supply current of each amplifier at  $125^{\circ}\text{C}$  is given by the following formula:

$$I_{\text{SMAX}} = 2.5 + 0.036 \cdot (V_S - 5) \text{ in mA}$$

$V_S$  is the total supply voltage.

The power in the IC due to the load is a function of the output voltage, the supply voltage and load resistance. The worst case occurs when the output voltage is at half supply, if it can go that far, or its maximum value if it cannot reach half supply.

For example, calculate the worst case power dissipation while operating on  $\pm 15\text{V}$  supplies and driving a  $500\Omega$  load.

$$I_{\text{SMAX}} = 2.5 + 0.036 \cdot (30 - 5) = 3.4\text{mA}$$

$$P_{\text{DMAX}} = 2 \cdot V_S \cdot I_{\text{SMAX}} + (V_S - V_{\text{OMAX}}) \cdot V_{\text{OMAX}}/R_L$$

$$P_{\text{DMAX}} = 2 \cdot 15\text{V} \times 3.4\text{mA} + (15\text{V} - 7.5\text{V}) \cdot 7.5\text{V}/500 \\ = 0.102 + 0.113 = 0.215\text{W per Amp}$$

If this is the quad LT1212, the total power in the package is four times that, or  $0.860\text{W}$ . Now calculate how much the die temperature will rise above the ambient. The total power dissipation times the thermal resistance of the package gives the amount of temperature rise. For this example, in the SO surface mount package, the thermal resistance is  $100^{\circ}\text{C}/\text{W}$  junction-to-ambient in still air.

$$\text{Temperature Rise} = P_{\text{DMAX}} \cdot \theta_{\text{JA}} = 0.860\text{W} \cdot 100^{\circ}\text{C}/\text{W} \\ = 86^{\circ}\text{C}$$

The maximum junction temperature allowed in the plastic package is  $150^{\circ}\text{C}$ . Therefore the maximum ambient allowed is the maximum junction temperature less the temperature rise.

$$\text{Maximum Ambient} = 150^{\circ}\text{C} - 86^{\circ}\text{C} = 64^{\circ}\text{C}$$

That means the SO quad can only be operated at or below  $64^{\circ}\text{C}$  on  $\pm 15\text{V}$  supplies with a  $500\Omega$  load.

As a guideline to help in the selection of the LT1211/LT1212, the following table describes the maximum supply voltage that can be used with each part based on the following assumptions:

1. The maximum ambient is  $70^{\circ}\text{C}$  or  $125^{\circ}\text{C}$  depending on the part rating.
2. The load is  $500\Omega$ , includes the feedback resistors.
3. The output can be anywhere between the supplies.

| PART      | MAX SUPPLIES                | MAX POWER AT MAX $T_A$ |
|-----------|-----------------------------|------------------------|
| LT1211MJ8 | 19.5V or $\pm 16.4\text{V}$ | 500mW                  |
| LT1211CN8 | 25.2V or $\pm 18.0\text{V}$ | 800mW                  |
| LT1211CS8 | 20.3V or $\pm 17.1\text{V}$ | 533mW                  |
| LT1212CN  | 21.0V or $\pm 17.8\text{V}$ | 1143mW                 |
| LT1212CS  | 17.3V or $\pm 14.4\text{V}$ | 800mW                  |

## APPLICATIONS INFORMATION

### Inputs

Typically, at room temperature, the inputs of the LT1211/LT1212 can common mode 400mV below ground ( $V^-$ ) and to within 1.2V of the positive supply with the amplifier still functional. However the input bias current and offset voltage will shift as shown in the characteristic curves. For full precision performance, the common-mode range should be limited between ground ( $V^-$ ) and 1.5V below the positive supply.

When either of the inputs is taken below ground ( $V^-$ ) by more than about 700mV, that input bias current will increase dramatically. The current is limited by internal 100 $\Omega$  resistors between the input pins and diodes to each supply. The output will remain low (no phase reversal) for inputs 1.3V below ground ( $V^-$ ). If the output does not have to sink current, such as in a single supply system with a 1k load to ground, there is no phase reversal for inputs up to 8V below ground.

There are no clamps across the inputs of the LT1211/LT1212 and therefore each input can be forced to any voltage between the supplies. The input current will remain constant at about 60nA over most of this range. When an input gets closer than 1.5V to the positive supply, that input current will gradually decrease to zero until the input goes above the supply, then it will increase due to the previously mentioned diodes. If the inverting input is held more positive than the noninverting input by 200mV or more, while at the same time the noninverting input is within 300mV of ground ( $V^-$ ), then the supply current will increase by 1mA and the noninverting input current will increase to about 10 $\mu$ A. This should be kept in mind in comparator applications where the inverting input stays above ground ( $V^-$ ) and the noninverting input is at or near ground ( $V^-$ ).

### Output

The output of the LT1211/LT1212 will swing to within 0.60V of the positive supply with no load. The open-loop output resistance, when the output is driven hard into the

positive rail, is about 100 $\Omega$  as the output starts to source current; this resistance drops to about 25 $\Omega$  as the current increases. Therefore when the output sources 1mA, the output will swing to within 0.7V of the positive supply. While sourcing 20mA, it is within 1.1V of the positive supply.

The output of the LT1211/LT1212 will swing to within 3mV of the negative supply while sinking zero current. Thus, in a typical single supply application with the load going to ground, the output will go to within 3mV of ground. The open-loop output resistance when the output is driven hard into the negative rail is about 44 $\Omega$  at low currents and reduces to about 24 $\Omega$  at high currents. Therefore, when the output sinks 1mA, the output is about 42mV above the negative supply and while sinking 20mA, it is about 480mV above it.

The output of the LT1211/LT1212 has reverse-biased diodes to each supply. If the output is forced beyond either supply, unlimited currents will flow. If the current is transient and limited to several hundred mA, no damage will occur.

### Feedback Components

Because the input currents of the LT1211/LT1212 are less than 125nA, it is possible to use high value feedback resistors to set the gain. However, care must be taken to insure that the pole that is formed by the feedback resistors and the input capacitance does not degrade the stability of the amplifier. For example, if a single supply, noninverting gain of two is set with two 20k resistors, the LT1211/LT1212 will probably oscillate. This is because the amplifier goes open-loop at 3MHz (6dB of gain) and has 50° of phase margin. The feedback resistors and the 10pF input capacitance generate a pole at 1.6MHz that introduces 63° of phase shift at 3MHz! The solution is simple; use lower value resistors or add a feedback capacitor of 10pF or more.

## APPLICATIONS INFORMATION

### Comparator Applications

Sometimes it is desirable to use an op amp as a comparator. When operating the LT1211/LT1212 on a single 3.3V or 5V supply, the output interfaces directly with most TTL and CMOS logic.

The response time of the LT1211/LT1212 is a strong function of the amount of input overdrive as shown in the

following photos. These amplifiers are unity-gain stable op amps and not fast comparators, therefore, the logic being driven may oscillate due to the long transition time. The output can be speeded up by adding 20mV or more of hysteresis (positive feedback), but the offset is then a function of the input direction.

**LT1211 Comparator Response (+)**  
20mV, 10mV, 5mV, 2mV Overdrives

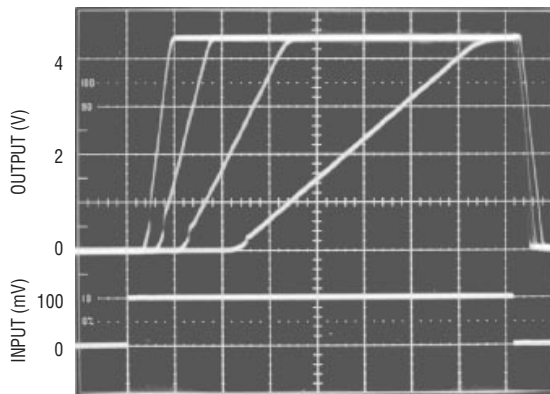

$V_S = 5V$   
 $R_L = \infty$

5µs/DIV

1211/12 AI01

**LT1211 Comparator Response (-)**  
20mV, 10mV, 5mV, 2mV Overdrives

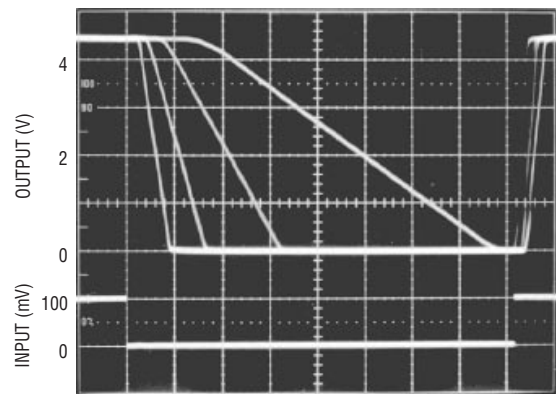

$V_S = 5V$   
 $R_L = \infty$

5µs/DIV

1211/12 AI02

## SIMPLIFIED SCHEMATIC

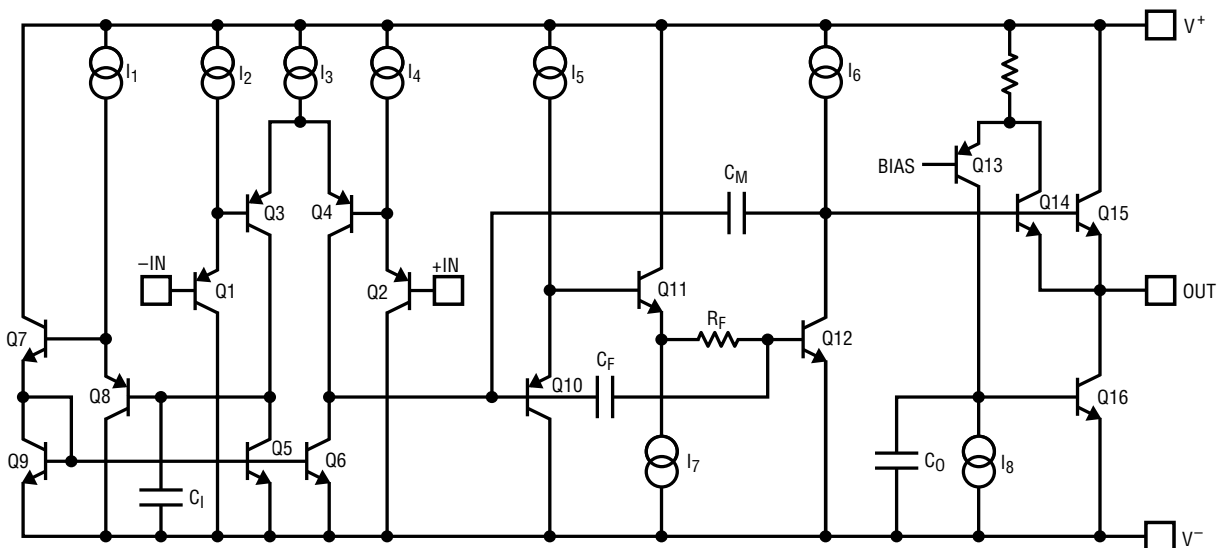

1211/12 SS

TYPICAL APPLICATIONS

1A Voltage-Controlled Current Source

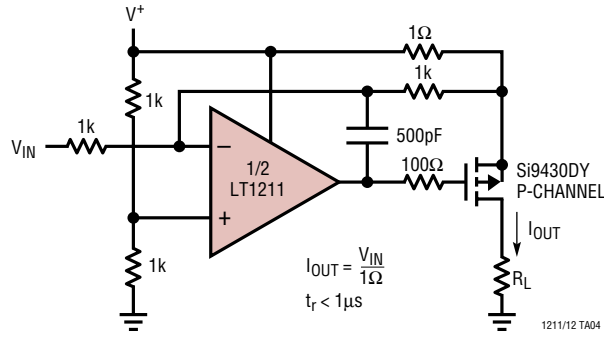

1A Voltage-Controlled Current Sink

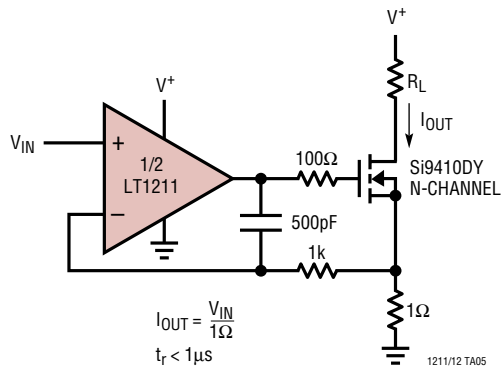



**PACKAGE DESCRIPTION**

**J8 Package**  
**8-Lead CERDIP (Narrow .300 Inch, Hermetic)**  
 (Reference LTC DWG # 05-08-1110)

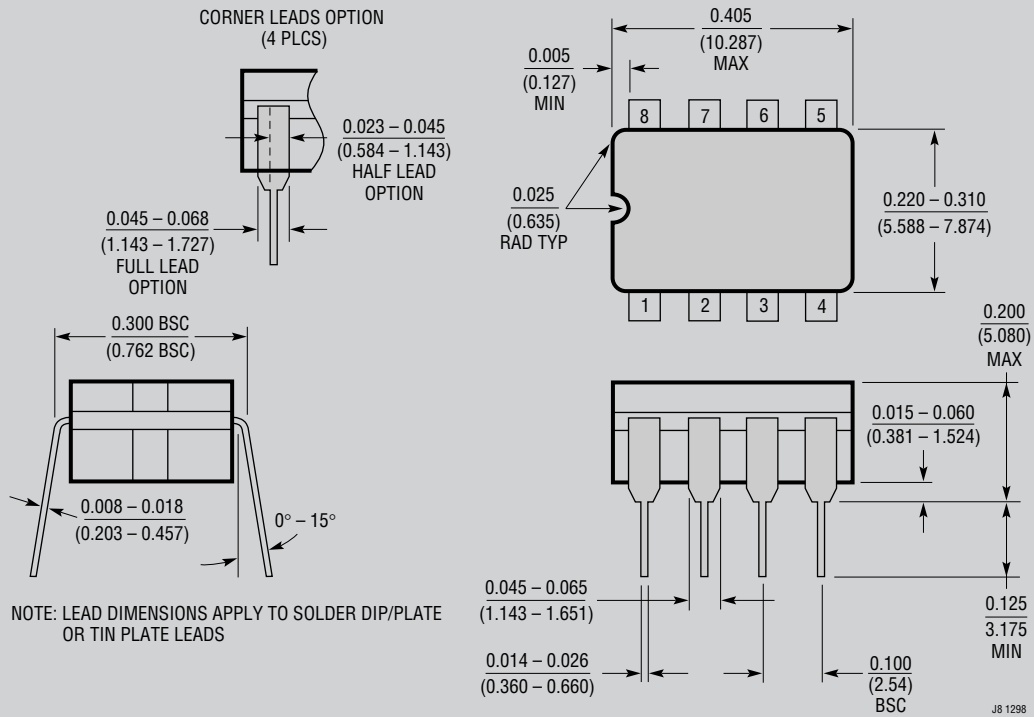

**OBSELETE PACKAGE**

**PACKAGE DESCRIPTION**

**N8 Package**  
**8-Lead PDIP (Narrow .300 Inch)**  
 (Reference LTC DWG # 05-08-1510)

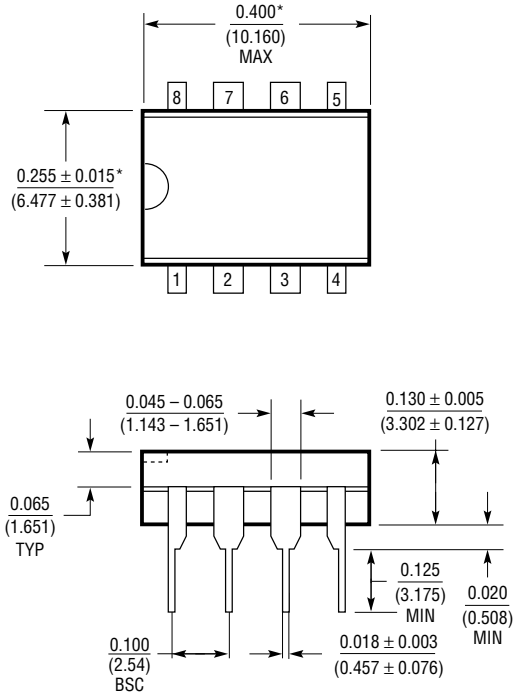

\*THESE DIMENSIONS DO NOT INCLUDE MOLD FLASH OR PROTRUSIONS.  
 MOLD FLASH OR PROTRUSIONS SHALL NOT EXCEED 0.010 INCH (0.254mm)

N8 1098

**N Package**  
**14-Lead PDIP (Narrow .300 Inch)**  
 (Reference LTC DWG # 05-08-1510)

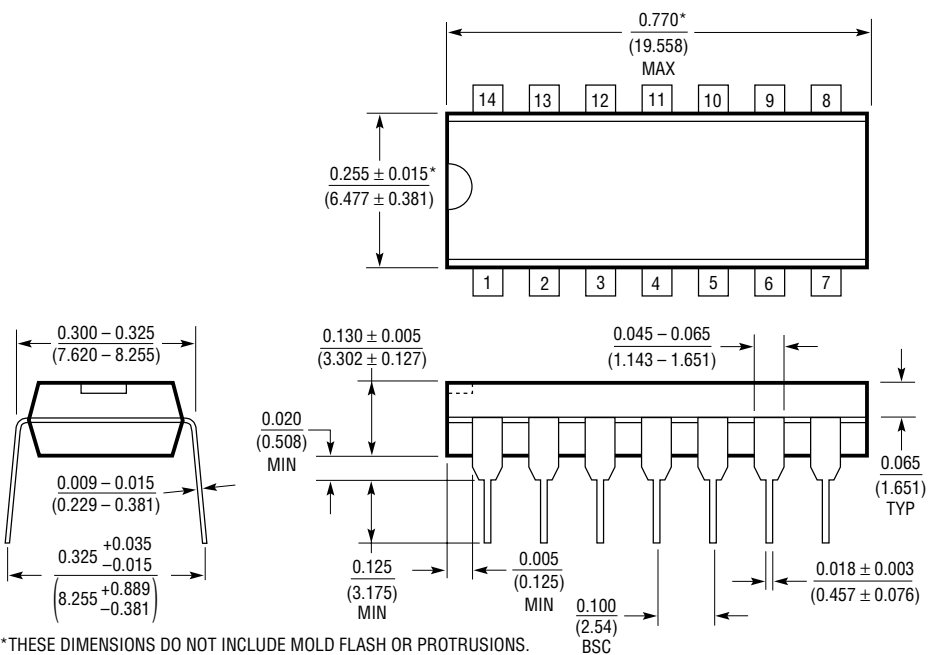

\*THESE DIMENSIONS DO NOT INCLUDE MOLD FLASH OR PROTRUSIONS.  
 MOLD FLASH OR PROTRUSIONS SHALL NOT EXCEED 0.010 INCH (0.254mm)

N14 1098

**PACKAGE DESCRIPTION**

**S8 Package**  
**8-Lead Plastic Small Outline (Narrow .150 Inch)**  
 (Reference LTC DWG # 05-08-1610)

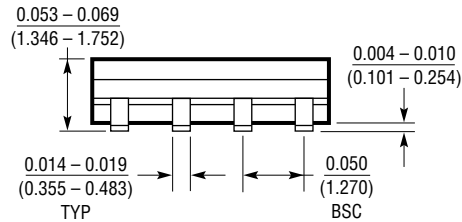
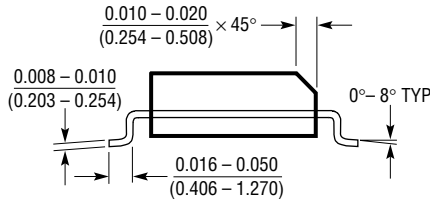
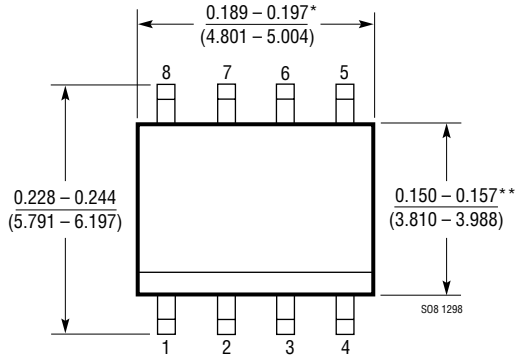

\*DIMENSION DOES NOT INCLUDE MOLD FLASH. MOLD FLASH SHALL NOT EXCEED 0.006" (0.152mm) PER SIDE

\*\*DIMENSION DOES NOT INCLUDE INTERLEAD FLASH. INTERLEAD FLASH SHALL NOT EXCEED 0.010" (0.254mm) PER SIDE

**S Package**  
**16-Lead Plastic Small Outline (Narrow .150 Inch)**  
 (Reference LTC DWG # 05-08-1610)

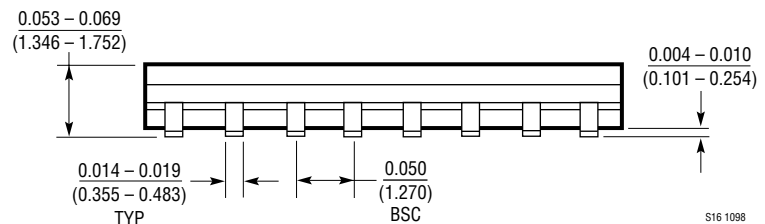
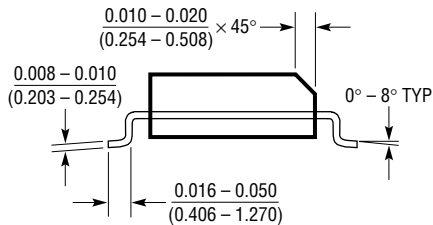
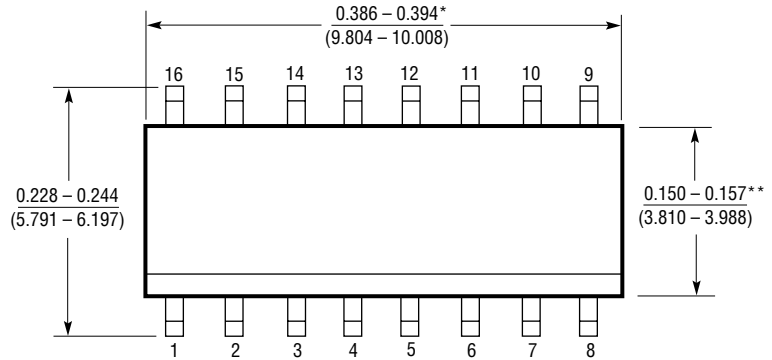

\*DIMENSION DOES NOT INCLUDE MOLD FLASH. MOLD FLASH SHALL NOT EXCEED 0.006" (0.152mm) PER SIDE

\*\*DIMENSION DOES NOT INCLUDE INTERLEAD FLASH. INTERLEAD FLASH SHALL NOT EXCEED 0.010" (0.254mm) PER SIDE

## TYPICAL APPLICATION

### Single Supply, 100kHz, 4th Order Butterworth Lowpass Filter

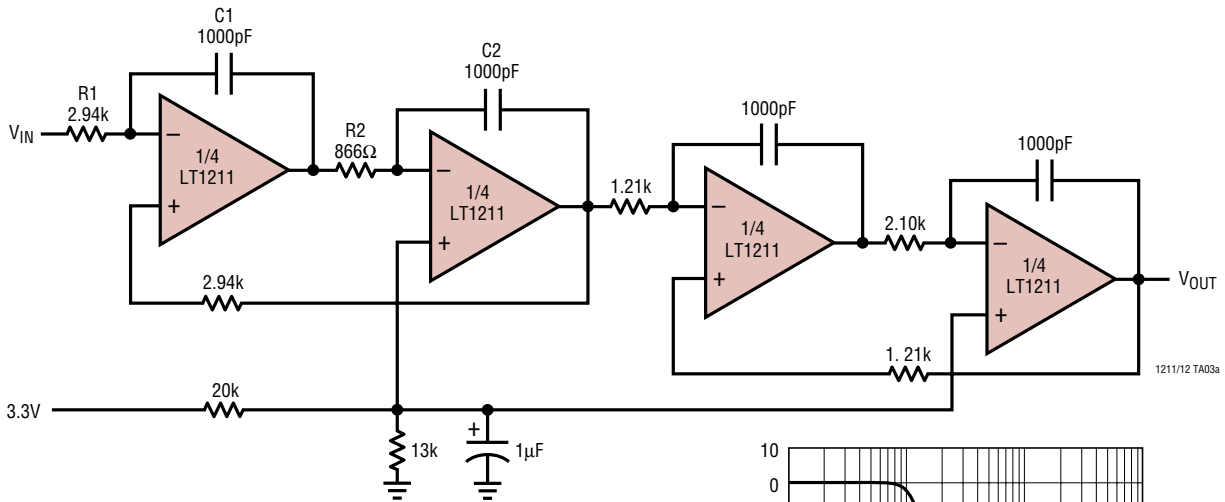

12-BIT ACCURATE SIGNAL RANGE FROM 6mV TO 1.8V ON 3.3V SINGLE SUPPLY.  
 MAXIMUM OUTPUT OFFSET ERROR IS 676μV.

FOR EACH 2ND ORDER SECTION:

$$W_0^2 = \frac{1}{C1C2R1R2}$$

$$R1 = \frac{1}{W_0QC1}$$

$$R2 = \frac{Q}{W_0C2}$$

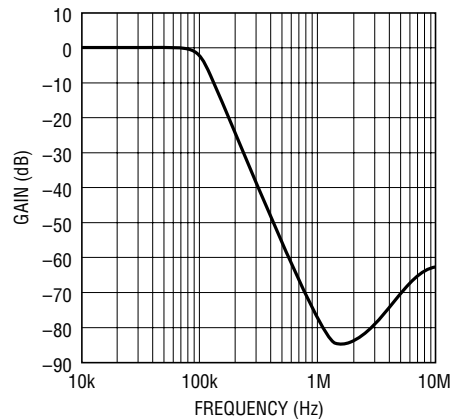

1211/12 TA03b

## RELATED PARTS

| PART NUMBER   | DESCRIPTION  | COMMENTS                     |
|---------------|--|------------------------------|
| LT1213/LT1214 | 28MHz, 12V/μs, Single Supply Dual and Quad Precision Op Amps                   | Twice as Fast as LT1211      |
| LT1215/LT1216 | 23MHz, 50V/μs, Single Supply Dual and Quad Precision Op Amps                   | Seven Times LT1211 Slew Rate |
| LT1498/LT1499 | 10MHz, 6V/μs, Dual/Quad Rail-to-Rail Input and Output Precision C-Load Op Amps | Rail-to-Rail LT1211          |
| LT1630/LT1631 | 30MHz, 10V/μs, Dual/Quad Rail-to-Rail Input and Output Precision Op Amps       | Rail-to-Rail LT1213          |
| LT1632/LT1633 | 45MHz, 45V/μs, Dual/Quad Rail-to-Rail Input and Output Precision Op Amps       | Rail-to-Rail LT1215          |