

# 2.5MHz, Over-The-Top Low Power, Rail-to-Rail Input and Output Op Amp in SOT-23

## FEATURES

- Operates with Inputs Above V<sup>+</sup>
- Rail-to-Rail Input and Output
- Gain Bandwidth Product: 2.5MHz
- Slew Rate: 2.1V/μs
- Low Input Offset Voltage: 3.5mV Max
- High Voltage Gain: 1000V/mV
- Single Supply Input Range: 0V to 18V
- Specified on 3V, 5V and ±5V Supplies
- Reverse Battery Protection to 18V
- Low Power: 750μA Supply Current Max
- Output Shutdown on 6-Lead Version
- High Output Current: 15mA Min
- Operating Temperature Range: -40°C to 85°C
- Low Profile (1mm) ThinSOT™ Package

## APPLICATIONS

- Portable Instrumentation
- Battery-Powered Systems
- Sensor Conditioning
- Supply Current Sensing
- MUX Amplifiers
- 4mA to 20mA Transmitters

## DESCRIPTION

The LT<sup>®</sup>1784 is a 2.5MHz op amp available in the small SOT-23 package that operates on all single and split supplies with a total voltage of 2.5V to 18V. The amplifier draws less than 750μA of quiescent current and has reverse battery protection, drawing negligible current for reverse supply voltages up to 18V.

The input range of the LT1784 includes ground, and a unique feature of this device is its Over-The-Top<sup>®</sup> operation capability with either or both of its inputs above the positive rail. The inputs handle 18V both differential and common mode, independent of supply voltage. The input stage incorporates phase reversal protection to prevent false outputs from occurring even when the inputs are 9V below the negative supply.

The LT1784 can drive loads up to 15mA and still maintain rail-to-rail capability. A shutdown feature on the 6-lead version can disable the part, making the output high impedance and reducing quiescent current to 5μA. The LT1784 op amp is available in the 5- and 6-lead SOT-23 packages. For applications requiring lower power, refer to the LT1782 and LT1783 data sheets.

LT, LT, LTC, LTM, Linear Technology, the Linear logo and Over-The-Top are registered trademarks of Linear Technology Corporation. ThinSOT is a trademark of Linear Technology Corporation. All other trademarks are the property of their respective owners.

## TYPICAL APPLICATION

Programmable Gain, A<sub>V</sub> = 2, A<sub>V</sub> = 20, 100kHz Amplifier

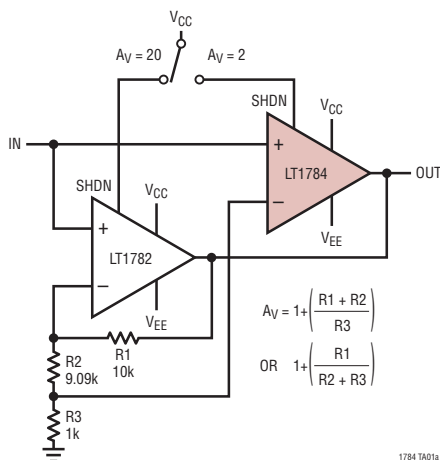

Programmable Gain Amplifier  
 Frequency Response

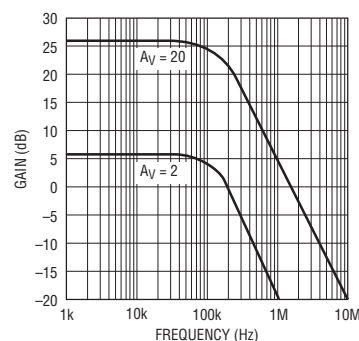

1784 TA01b

1784 TA01a

1784fa

## ABSOLUTE MAXIMUM RATINGS (Note 1)

Total Supply Voltage ( $V^+$ to $V^-$ ) .....	18V	Operating Temperature Range (Note 10) ..	-40°C to 85°C
Input Differential Voltage .....	18V	Specified Temperature Range (Note 11) ..	-40°C to 85°C
Input Pin Voltage to $V^-$ .....	+24V/-10V	Junction Temperature .....	150°C
Shutdown Pin Voltage Above $V^-$ .....	18V	Storage Temperature Range .....	-65°C to 150°C
Shutdown Pin Current .....	±10mA	Lead Temperature (Soldering, 10 sec) .....	300°C
Output Short-Circuit Duration (Note 2) .....	Indefinite		

## PIN CONFIGURATION

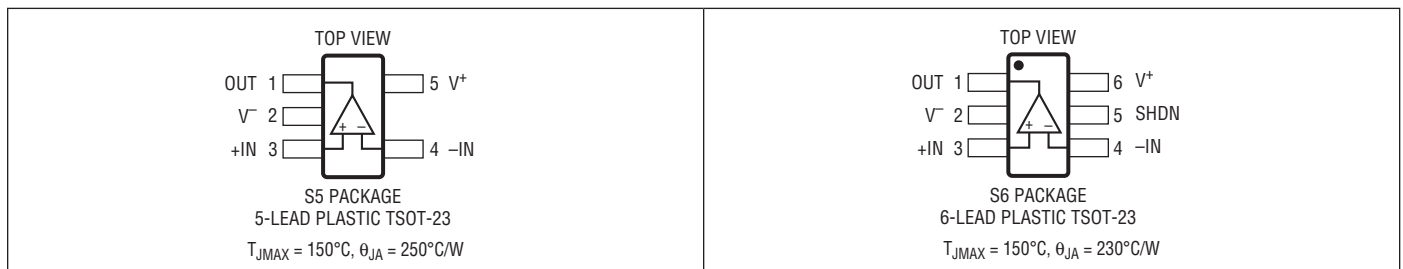

## ORDER INFORMATION

LEAD FREE FINISH	TAPE AND REEL	PART MARKING	PACKAGE DESCRIPTION	SPECIFIED TEMPERATURE RANGE
LT1784CS5#PBF	LT1784CS5#TRPBF	LTJD	5-Lead Plastic TSOT-23	-40°C to 85°C
LT1784IS5#PBF	LT1784IS5#TRPBF	LTSN	5-Lead Plastic TSOT-23	-40°C to 85°C
LT1784CS6#PBF	LT1784CS6#TRPBF	LTIW	6-Lead Plastic TSOT-23	-40°C to 85°C
LT1784IS6#PBF	LT1784IS6#TRPBF	LTIX	6-Lead Plastic TSOT-23	-40°C to 85°C

Consult LTC Marketing for parts specified with wider operating temperature ranges.

Consult LTC Marketing for information on non-standard lead based finish parts.

For more information on lead free part marking, go to: <http://www.linear.com/leadfree/>

For more information on tape and reel specifications, go to: <http://www.linear.com/tapeandreeel/>

**ELECTRICAL CHARACTERISTICS** The ● denotes the specifications which apply over the specified temperature range, otherwise specifications are at  $T_A = 25^{\circ}\text{C}$ .  $V_S = 3\text{V}, 0\text{V}$ ;  $V_S = 5\text{V}, 0\text{V}$ ,  $V_{CM} = V_{OUT} = \text{half supply}$ , for the 6-lead part  $V_{PIN5} = 0\text{V}$ , pulse power tested unless otherwise specified.

SYMBOL	PARAMETER	CONDITIONS	MIN	TYP	MAX	UNITS
$V_{OS}$	Input Offset Voltage	$T_A = 25^{\circ}\text{C}$		1.5	3.5	mV
		$0^{\circ}\text{C} \leq T_A \leq 70^{\circ}\text{C}$	●		4.2	mV
		$-40^{\circ}\text{C} \leq T_A \leq 85^{\circ}\text{C}$	●		4.5	mV
$\Delta V_{OS}/\Delta T$	Input Offset Voltage Drift (Note 7)	$-40^{\circ}\text{C} \leq T_A \leq 85^{\circ}\text{C}$	●	5	15	$\mu\text{V}/^{\circ}\text{C}$
$I_{OS}$	Input Offset Current	$V_{CM} = 18\text{V}$ (Note 3)	●	25	50	nA
			●		50	$\mu\text{A}$

**ELECTRICAL CHARACTERISTICS** The ● denotes the specifications which apply over the specified temperature range, otherwise specifications are at  $T_A = 25^\circ\text{C}$ .  $V_S = 3\text{V}, 0\text{V}$ ;  $V_S = 5\text{V}, 0\text{V}$ ,  $V_{\text{CM}} = V_{\text{OUT}} = \text{half supply}$ , for the 6-lead part  $V_{\text{PIN5}} = 0\text{V}$ , pulse power tested unless otherwise specified.

SYMBOL	PARAMETER	CONDITIONS	MIN	TYP	MAX	UNITS	
$I_B$	Input Bias Current	$V_{\text{CM}} = 18\text{V}$ (Note 3) SHDN or $V_S = 0\text{V}$ , $V_{\text{CM}} = 0\text{V}$ to $18\text{V}$	●	250	500	nA	
			●	225	400	$\mu\text{A}$	
				0.1		nA	
$\Delta I_B/\Delta T$	Input Bias Current Drift	$-40^\circ\text{C} \leq T_A \leq 85^\circ\text{C}$	●	0.4		nA/ $^\circ\text{C}$	
	Input Noise Voltage	0.1Hz to 10Hz		1.5		$\mu\text{V}_{\text{P-P}}$	
$e_n$	Input Noise Voltage Density	$f = 10\text{kHz}$		25		nV/ $\sqrt{\text{Hz}}$	
$i_n$	Input Noise Current Density	$f = 10\text{kHz}$		0.3		pA/ $\sqrt{\text{Hz}}$	
$R_{\text{IN}}$	Input Resistance	Differential Common Mode, $V_{\text{CM}} = 0\text{V}$ to $(V_{\text{CC}} - 1.2\text{V})$ Common Mode, $V_{\text{CM}} = 0\text{V}$ to $18\text{V}$		100	200	k $\Omega$	
					150	M $\Omega$	
				45	80	k $\Omega$	
$C_{\text{IN}}$	Input Capacitance			5		pF	
$V_{\text{CM}}$	Input Voltage Range		●	0	18	V	
CMRR	Common Mode Rejection Ratio (Note 3)	$V_{\text{CM}} = 0\text{V}$ to $V_{\text{CC}} - 1.2\text{V}$ $V_{\text{CM}} = 0\text{V}$ to $18\text{V}$ (Note 6)	●	84	95	dB	
			●	60	70	dB	
PSRR	Power Supply Rejection Ratio	$V_S = 3\text{V}$ to $12.5\text{V}$ , $V_{\text{CM}} = V_O = 1\text{V}$	●	90	100	dB	
$A_{\text{VOL}}$	Large-Signal Voltage Gain	$V_S = 3\text{V}$ , $V_O = 500\text{mV}$ to $2.5\text{V}$ , $R_L = 10\text{k}$ $V_S = 3\text{V}$ , $0^\circ\text{C} \leq T_A \leq 70^\circ\text{C}$ $V_S = 3\text{V}$ , $-40^\circ\text{C} \leq T_A \leq 85^\circ\text{C}$	●	133	1000	V/mV	
			●	90		V/mV	
			●	60		V/mV	
		$V_S = 5\text{V}$ , $V_O = 500\text{mV}$ to $4.5\text{V}$ , $R_L = 10\text{k}$ $V_S = 5\text{V}$ , $0^\circ\text{C} \leq T_A \leq 70^\circ\text{C}$ $V_S = 5\text{V}$ , $-40^\circ\text{C} \leq T_A \leq 85^\circ\text{C}$	●	266	1000	V/mV	
			●	180		V/mV	
			●	120		V/mV	
$V_{\text{OL}}$	Output Voltage Swing LOW	No Load $I_{\text{SINK}} = 5\text{mA}$ $V_S = 5\text{V}$ , $I_{\text{SINK}} = 10\text{mA}$	●		4	10	mV
			●		200	400	mV
			●		350	600	mV
$V_{\text{OH}}$	Output Voltage Swing HIGH	$V_S = 3\text{V}$ , No Load $V_S = 3\text{V}$ , $I_{\text{SOURCE}} = 3\text{mA}$	●	2.885	2.93	V	
			●	2.600	2.8	V	
		$V_S = 5\text{V}$ , No Load $V_S = 5\text{V}$ , $I_{\text{SOURCE}} = 10\text{mA}$	●	4.885	4.93	V	
			●	4.400	4.7	V	
$I_{\text{SC}}$	Short-Circuit Current (Note 2)	$V_S = 3\text{V}$ , Short to GND $V_S = 3\text{V}$ , Short to $V_{\text{CC}}$		4	7.5	mA	
				15	30	mA	
		$V_S = 5\text{V}$ , Short to GND $V_S = 5\text{V}$ , Short to $V_{\text{CC}}$		12.5	22	mA	
				20.0	40	mA	
	Minimum Supply Voltage		●	2.5	2.7	V	
	Reverse Supply Voltage	$I_S = -100\mu\text{A}$	●	18		V	
$I_S$	Supply Current (Note 4)		●	500	750	$\mu\text{A}$	
			●		900	$\mu\text{A}$	
	Supply Current, Shutdown	$V_{\text{PIN5}} = 2\text{V}$ , No Load (Note 8)	●	7	18	$\mu\text{A}$	
$I_{\text{SHDN}}$	SHDN Pin Current	$V_{\text{PIN5}} = 0.3\text{V}$ (On), No Load (Note 8) $V_{\text{PIN5}} = 2\text{V}$ (Shutdown), No Load (Note 8) $V_{\text{PIN5}} = 5\text{V}$ (Shutdown), No Load (Note 8)	●	0.5		nA	
			●	2.0	8	$\mu\text{A}$	
				5.0		$\mu\text{A}$	
	Output Leakage Current, Shutdown	$V_{\text{PIN5}} = 2\text{V}$ , No Load (Note 8)	●	0.05	1	$\mu\text{A}$	
	Maximum SHDN Pin Current	$V_{\text{PIN5}} = 18\text{V}$ , No Load (Note 8)	●	10	30	$\mu\text{A}$	
$V_{\text{IL}}$	SHDN Pin Input Low Voltage	(Note 8)	●		0.3	V	
$V_{\text{IH}}$	SHDN Pin Input High Voltage	(Note 8)	●	2		V	
$t_{\text{ON}}$	Turn-On Time	$V_{\text{PIN5}} = 5\text{V}$ to $0\text{V}$ , $R_L = 10\text{k}$ (Note 8)		18		$\mu\text{s}$	
$t_{\text{OFF}}$	Turn-Off Time	$V_{\text{PIN5}} = 0\text{V}$ to $5\text{V}$ , $R_L = 10\text{k}$ (Note 8)		2.2		$\mu\text{s}$	

**ELECTRICAL CHARACTERISTICS** The ● denotes the specifications which apply over the specified temperature range, otherwise specifications are at  $T_A = 25^\circ\text{C}$ .  $V_S = 3\text{V}, 0\text{V}$ ;  $V_S = 5\text{V}, 0\text{V}$ ,  $V_{\text{CM}} = V_{\text{OUT}} = \text{half supply}$ , for the 6-lead part  $V_{\text{PIN5}} = 0\text{V}$ , pulse power tested unless otherwise specified.

SYMBOL	PARAMETER	CONDITIONS	MIN	TYP	MAX	UNITS
GBW	Gain Bandwidth Product (Note 4)	$f = 5\text{kHz}$	1.5	2.5		MHz
		$0^\circ\text{C} \leq T_A \leq 70^\circ\text{C}$	● 1.2			MHz
		$-40^\circ\text{C} \leq T_A \leq 85^\circ\text{C}$	● 1.1			MHz
SR	Slew Rate (Note 5)	$A_V = -1, R_L = \infty$	1.2	2.1		V/ $\mu\text{s}$
		$0^\circ\text{C} \leq T_A \leq 70^\circ\text{C}$	● 1.1			V/ $\mu\text{s}$
		$-40^\circ\text{C} \leq T_A \leq 85^\circ\text{C}$	● 1.0			V/ $\mu\text{s}$
FPBW	Full-Power Bandwidth (Note 9)	$V_{\text{OUT}} = 2V_{\text{P-P}}$		350		kHz
$t_S$	Settling Time	$V_S = 5\text{V}, \Delta V_{\text{OUT}} = 2\text{V}$ to 0.1%, $A_V = -1$		3.7		$\mu\text{s}$
THD	Distortion	$V_S = 3\text{V}, V_0 = 1.8V_{\text{P-P}}, A_V = 1, R_L = 10\text{k}, f = 1\text{kHz}$		0.001		%

The ● denotes the specifications which apply over the specified temperature range, otherwise specifications are at  $T_A = 25^\circ\text{C}$ .  $V_S = \pm 5\text{V}$ ,  $V_{\text{CM}} = 0\text{V}$ ,  $V_{\text{OUT}} = 0\text{V}$ , for the 6-lead part  $V_{\text{PIN5}} = V^-$ , pulse power tested unless otherwise specified.

SYMBOL	PARAMETER	CONDITIONS	MIN	TYP	MAX	UNITS
$V_{\text{OS}}$	Input Offset Voltage	$T_A = 25^\circ\text{C}$		1.6	3.75	mV
		$0^\circ\text{C} \leq T_A \leq 70^\circ\text{C}$	●		4.50	mV
		$-40^\circ\text{C} \leq T_A \leq 85^\circ\text{C}$	●		4.80	mV
$\Delta V_{\text{OS}}/\Delta T$	Input Offset Voltage Drift (Note 7)	$-40^\circ\text{C} \leq T_A \leq 85^\circ\text{C}$	●	5	15	$\mu\text{V}/^\circ\text{C}$
$I_{\text{OS}}$	Input Offset Current		●	25	50	nA
$I_B$	Input Bias Current		●	250	500	nA
$\Delta I_B/\Delta T$	Input Bias Current Drift	$0^\circ\text{C} \leq T_A \leq 70^\circ\text{C}$	●	0.4		nA/ $^\circ\text{C}$
	Input Noise Voltage	0.1Hz to 10Hz		1.5		$\mu\text{V}_{\text{P-P}}$
$e_n$	Input Noise Voltage Density	$f = 1\text{kHz}$		25		nV/ $\sqrt{\text{Hz}}$
$i_n$	Input Noise Current Density	$f = 1\text{kHz}$		0.3		pA/ $\sqrt{\text{Hz}}$
$R_{\text{IN}}$	Input Resistance	Differential	●	100	200	k $\Omega$
		Common Mode, $V_{\text{CM}} = -5\text{V}$ to 13V	●	45	80	k $\Omega$
$C_{\text{IN}}$	Input Capacitance			5		pF
$V_{\text{CM}}$	Input Voltage Range		●	-5	13	V
CMRR	Common Mode Rejection Ratio	$V_{\text{CM}} = -5\text{V}$ to 13V	●	60	70	dB
$A_{\text{VOL}}$	Large-Signal Voltage Gain	$V_0 = \pm 4\text{V}, R_L = 10\text{k}$	●	50	100	V/mV
		$0^\circ\text{C} \leq T_A \leq 70^\circ\text{C}$	●	35		V/mV
$V_{\text{OL}}$	Output Voltage Swing LOW	No Load	●	-4.996	-4.99	V
		$I_{\text{SINK}} = 5\text{mA}$	●	-4.800	-4.60	V
		$I_{\text{SINK}} = 10\text{mA}$	●	-4.650	-4.40	V
$V_{\text{OH}}$	Output Voltage Swing HIGH	No Load	●	4.885	4.92	V
		$I_{\text{SOURCE}} = 5\text{mA}$	●	4.550	4.75	V
		$I_{\text{SOURCE}} = 10\text{mA}$	●	4.400	4.65	V
$I_{\text{SC}}$	Short-Circuit Current (Note 2)	Short to GND	●	15	27	mA
		$0^\circ\text{C} \leq T_A \leq 70^\circ\text{C}$	●	10		mA
PSRR	Power Supply Rejection Ratio	$V_S = \pm 1.5\text{V}$ to $\pm 9\text{V}$	●	90	100	dB
$I_S$	Supply Current		●	540	800	$\mu\text{A}$
			●		975	$\mu\text{A}$
	Supply Current, Shutdown	$V_{\text{PIN5}} = -3\text{V}, V_S = \pm 5\text{V}$ , No Load (Note 8)	●	8	20	$\mu\text{A}$
$I_{\text{SHDN}}$	SHDN Pin Current	$V_{\text{PIN5}} = -4.7\text{V}$ (On), $V_S = \pm 5\text{V}$ , No Load (Note 8)	●	0.5		nA
		$V_{\text{PIN5}} = -3\text{V}$ (Shutdown), $V_S = \pm 5\text{V}$ , No Load (Note 8)	●	2.0	8	$\mu\text{A}$
	Maximum SHDN Pin Current	$V_{\text{PIN5}} = 9\text{V}, V_S = \pm 9\text{V}$ (Note 8)	●	10	30	$\mu\text{A}$
	Output Leakage Current, Shutdown	$V_{\text{PIN5}} = -7\text{V}, V_S = \pm 9\text{V}$ , No Load (Note 8)	●	0.05	1	$\mu\text{A}$

**ELECTRICAL CHARACTERISTICS** The ● denotes the specifications which apply over the specified temperature range, otherwise specifications are at  $T_A = 25^\circ\text{C}$ .  $V_S = \pm 5\text{V}$ ,  $V_{\text{CM}} = 0\text{V}$ ,  $V_{\text{OUT}} = 0\text{V}$ , for the 6-lead part  $V_{\text{PIN5}} = V^-$ , pulse power tested unless otherwise specified.

SYMBOL	PARAMETER	CONDITIONS	MIN	TYP	MAX	UNITS
$V_{\text{IL}}$	SHDN Pin Input Low Voltage	$V_S = \pm 5\text{V}$ (Note 8)	●		-4.7	V
$V_{\text{IH}}$	SHDN Pin Input High Voltage	$V_S = \pm 5\text{V}$ (Note 8)	●	-3		V
$t_{\text{ON}}$	Turn-On Time	$V_{\text{PIN5}} = 0\text{V}$ to $-5\text{V}$ , $R_L = 10\text{k}$ (Note 8)	●	18		$\mu\text{s}$
$t_{\text{OFF}}$	Turn-Off Time	$V_{\text{PIN5}} = -5\text{V}$ to $0\text{V}$ , $R_L = 10\text{k}$ (Note 8)	●	2.2		$\mu\text{s}$
GBW	Gain Bandwidth Product	$f = 5\text{kHz}$	●	1.55	2.6	MHz
		$0^\circ\text{C} \leq T_A \leq 70^\circ\text{C}$	●	1.30		MHz
		$-40^\circ\text{C} \leq T_A \leq 85^\circ\text{C}$	●	1.20		MHz
SR	Slew Rate	$A_V = -1$ , $R_L = \infty$ , $V_O = \pm 4\text{V}$ , Measured at $V_O = \pm 2\text{V}$	●	1.3	2.2	V/ $\mu\text{s}$
		$0^\circ\text{C} \leq T_A \leq 70^\circ\text{C}$	●	1.2		V/ $\mu\text{s}$
		$-40^\circ\text{C} \leq T_A \leq 85^\circ\text{C}$	●	1.1		V/ $\mu\text{s}$
FPBW	Full-Power Bandwidth (Note 9)	$V_{\text{OUT}} = 8V_{\text{P-P}}$		94		kHz
$t_S$	Settling Time	$V_S = 5\text{V}$ , $\Delta V_{\text{OUT}} = 4\text{V}$ to $0.1\%$ , $A_V = 1$		3.4		$\mu\text{s}$

**Note 1:** Stresses beyond those listed under Absolute Maximum Ratings may cause permanent damage to the device. Exposure to any Absolute Maximum Rating condition for extended periods may affect device reliability and lifetime.

**Note 2:** A heat sink may be required to keep the junction temperature below absolute maximum.

**Note 3:**  $V_S = 5\text{V}$  limits are guaranteed by correlation to  $V_S = 3\text{V}$  and  $V_S = \pm 5\text{V}$  or  $V_S = \pm 9\text{V}$  tests.

**Note 4:**  $V_S = 3\text{V}$  limits are guaranteed by correlation to  $V_S = 5\text{V}$  and  $V_S = \pm 5\text{V}$  or  $V_S = \pm 9\text{V}$  tests.

**Note 5:** Guaranteed by correlation to slew rate at  $V_S = \pm 5\text{V}$ , and GBW at  $V_S = 5\text{V}$  and  $V_S = \pm 5\text{V}$  tests.

**Note 6:** This specification implies a typical input offset voltage of 5.7mV at  $V_{\text{CM}} = 18\text{V}$  and a maximum input offset voltage of 18mV at  $V_{\text{CM}} = 18\text{V}$ .

**Note 7:** This parameter is not 100% tested.

**Note 8:** Specifications apply to 6-lead SOT-23 with shutdown.

**Note 9:** Full-power bandwidth is calculated from the slew rate.  $\text{FPBW} = \text{SR}/2\pi V_P$ .

**Note 10:** The LT1784C is guaranteed functional over the operating temperature range  $-40^\circ\text{C}$  to  $85^\circ\text{C}$ .

**Note 11:** The LT1784C is guaranteed to meet specified performance from  $0^\circ\text{C}$  to  $70^\circ\text{C}$ . The LT1784C is designed, characterized and expected to meet specified performance from  $-40^\circ\text{C}$  to  $85^\circ\text{C}$  but is not tested or QA sampled at these temperatures. LT1784I is guaranteed to meet specified performance from  $-40^\circ\text{C}$  to  $85^\circ\text{C}$ .

**TYPICAL PERFORMANCE CHARACTERISTICS**

Supply Current vs Supply Voltage

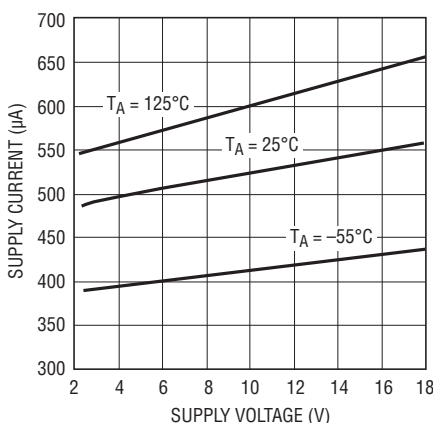

1784 G01

Minimum Supply Voltage

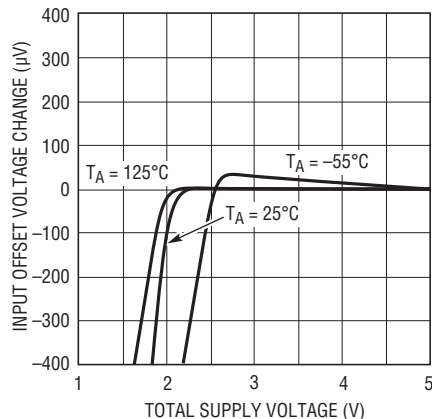

1784 G02

Output Voltage vs Large Input Voltage

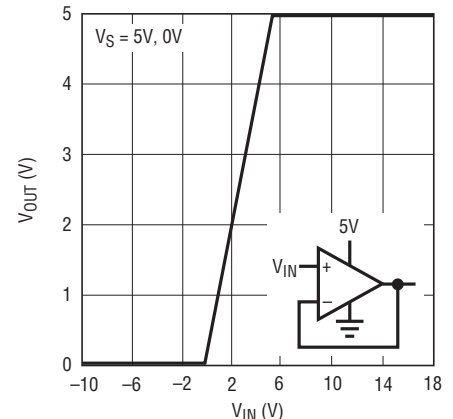

1784 G03

1784fa

TYPICAL PERFORMANCE CHARACTERISTICS

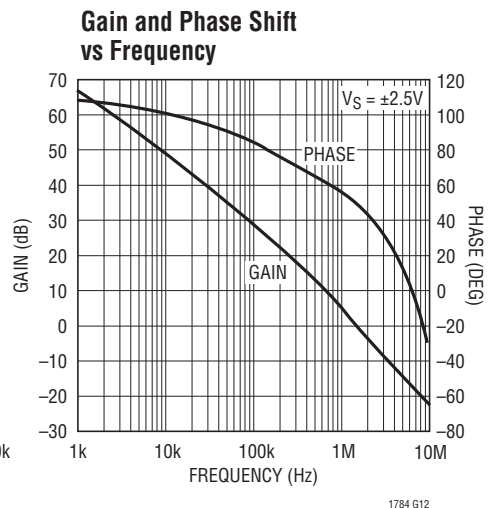
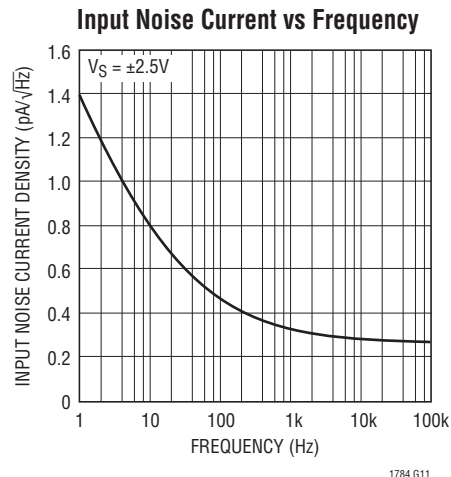
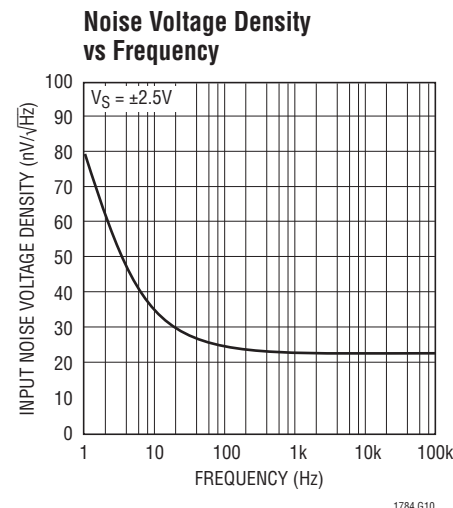
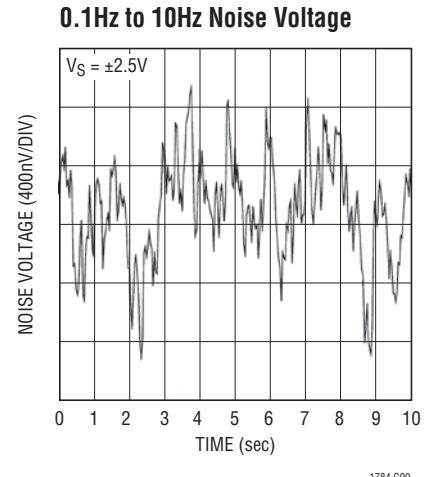
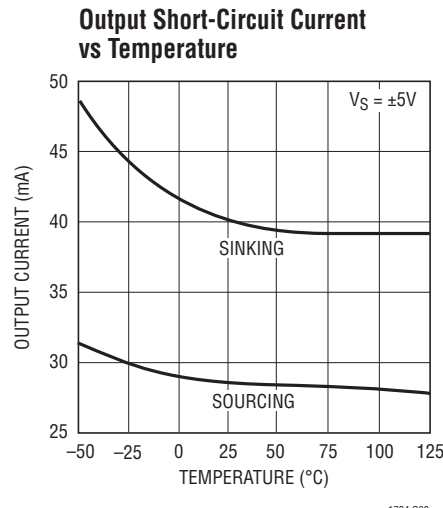
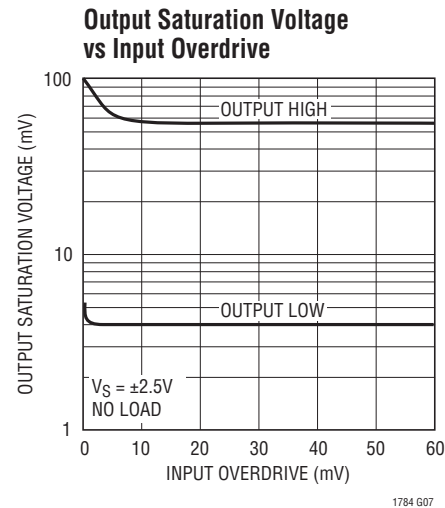
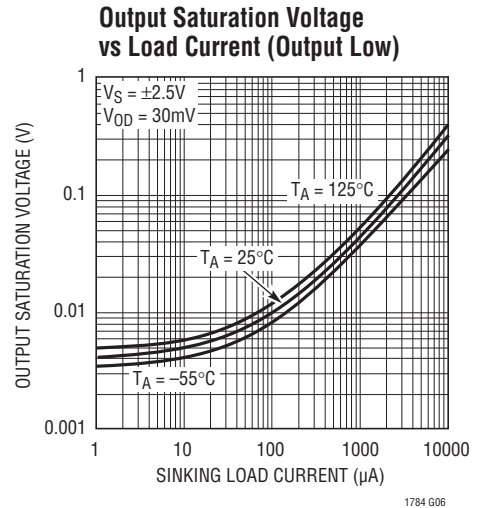
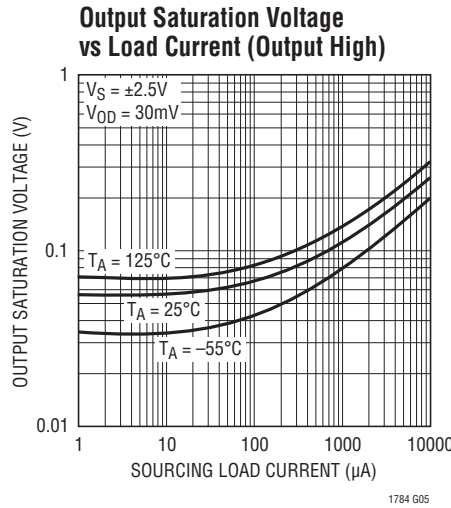
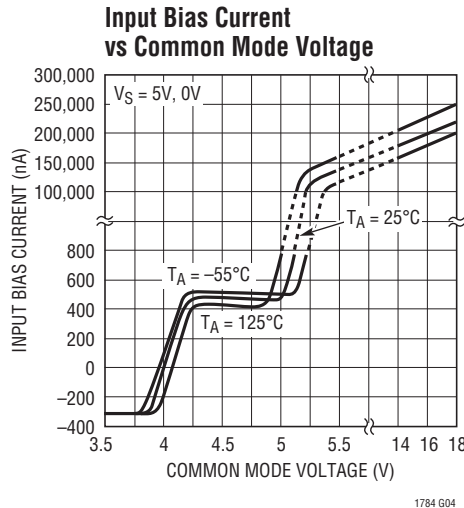

# TYPICAL PERFORMANCE CHARACTERISTICS

**Gain Bandwidth Product vs Temperature**

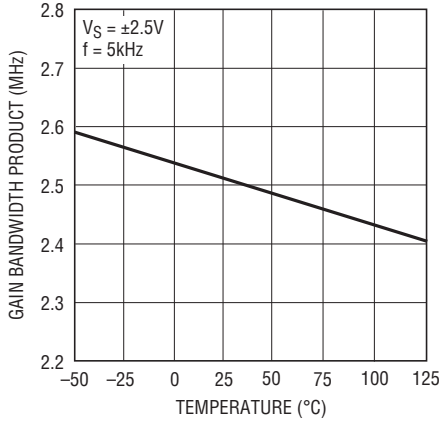

1784 G13

**Slew Rate vs Temperature**

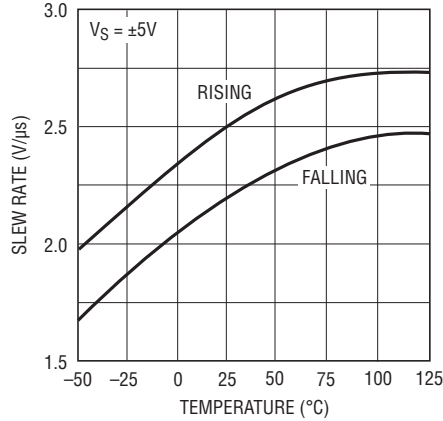

1784 G14

**Gain Bandwidth Product and Phase Margin vs Supply Voltage**

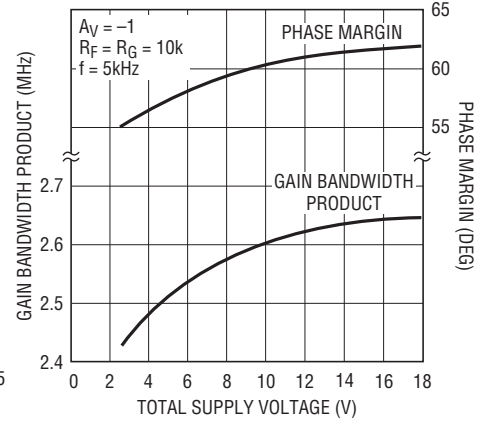

1784 G15

**Gain Bandwidth and Phase Margin vs Load Resistance**

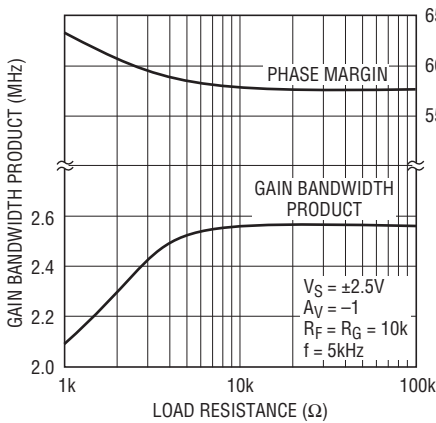

1784 G16

**PSRR vs Frequency**

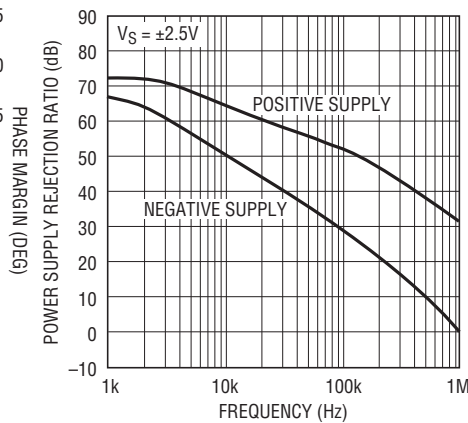

1784 G17

**CMRR vs Frequency**

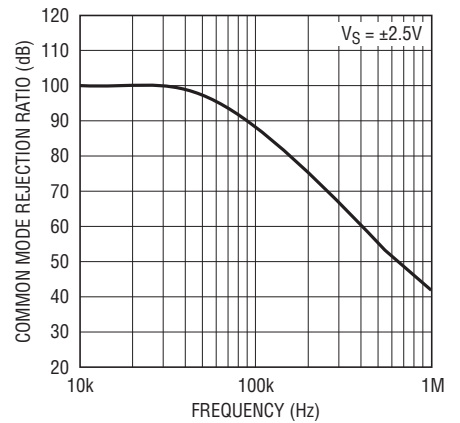

1784 G18

**Output Impedance vs Frequency**

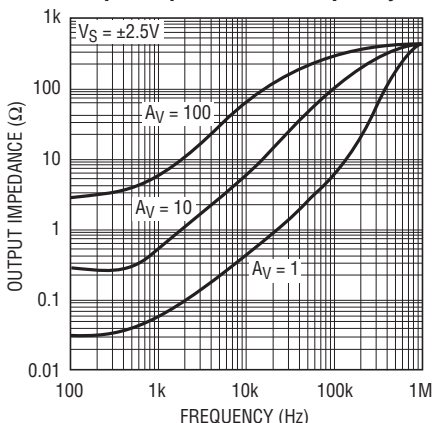

1784 G19

**Disabled Output Impedance vs Frequency**

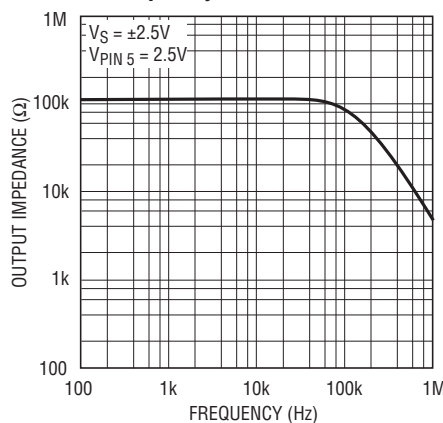

1784 G20

**Settling Time to 0.1% vs Output Step**

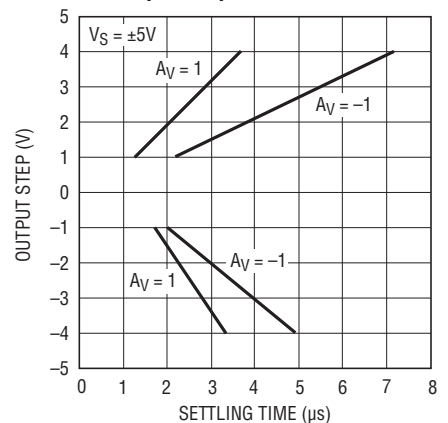

1784 G21

TYPICAL PERFORMANCE CHARACTERISTICS

Capacitive Load Handling  
Overshoot vs Capacitive Load

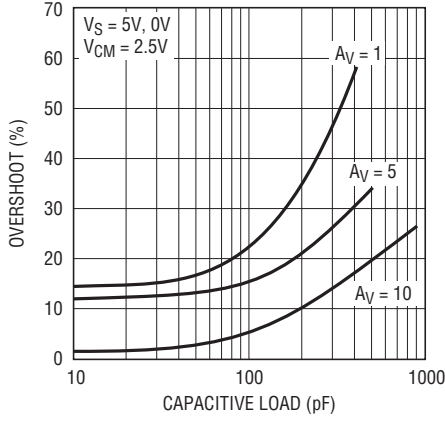

1784 G22

Undistorted Output Swing  
vs Frequency

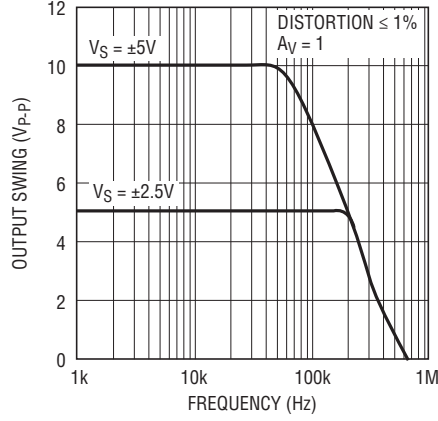

1784 G23

Total Harmonic Distortion + Noise  
vs Frequency

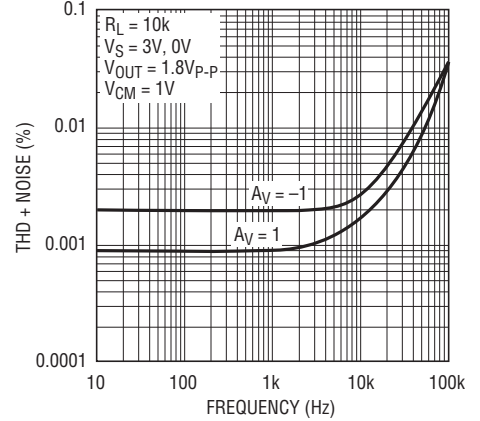

1784 G24

Total Harmonic Distortion + Noise  
vs Load Resistance

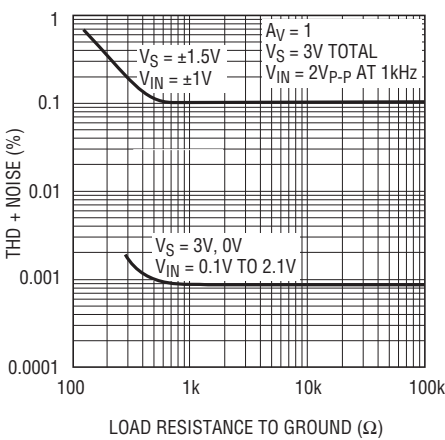

1784 G25

Total Harmonic Distortion + Noise  
vs Output Voltage Amplitude

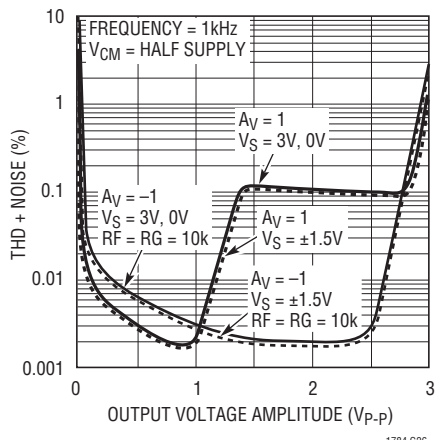

1784 G26

Open-Loop Gain

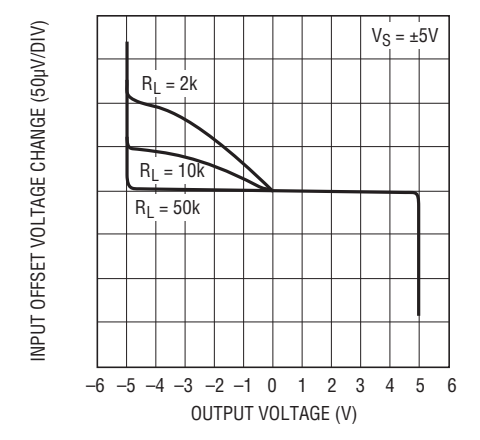

1784 G27

Supply Current  
vs SHDN Pin Voltage

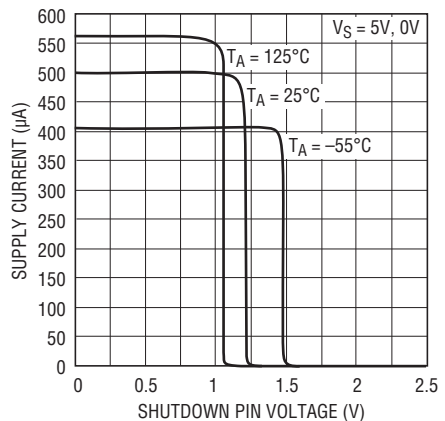

1784 G28

Large Signal Response

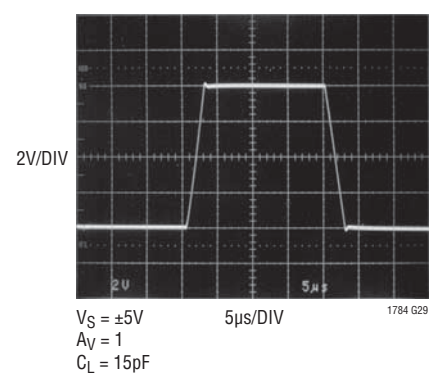

1784 G29

Small Signal Response

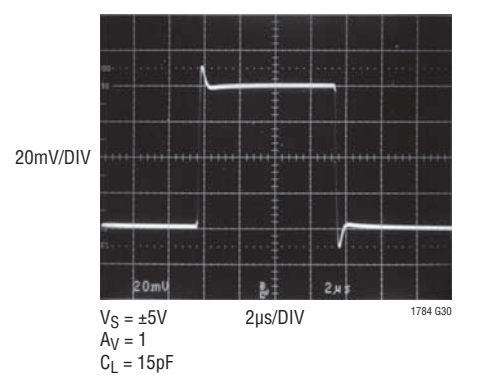

1784 G30



## APPLICATIONS INFORMATION

### Supply Voltage

The positive supply pin of the LT1784 should be bypassed with a small capacitor (typically 0.1 $\mu$ F) within an inch of the pin. When driving heavy loads, and additional 4.7 $\mu$ F electrolytic capacitor should be used. When using split supplies the same is true for the negative supply pin.

The LT1784 is protected against reverse battery voltages up to 18V. In the event a reverse battery condition occurs the supply current is less than 1nA.

### Inputs

The LT1784 has two input stages, NPN and PNP (see the Simplified Schematic), resulting in three distinct operating regions as shown in the “Input Bias Current vs Common Mode” Typical Performance Characteristic curve.

For input voltages about 1V or more below  $V^+$ , the PNP input stage is active and the input bias current is typically  $-250$ nA. When the input common mode voltage is within 0.6V of the positive rail, the NPN stage is operating and the input bias current is typically 500nA. Increases in temperature will cause the voltage at which operation switches from the PNP input stage to the NPN input stage to move towards  $V^+$ . The input offset voltage of the NPN stage is untrimmed and is typically 3mV.

A Schottky diode in the collector of the input transistors, along with special geometries for these NPN transistors, allow the LT1784 to operate with either or both of its inputs above  $V^+$ . At about 0.3V above  $V^+$ , the NPN input transistors is fully saturated and the input bias current is typically 200 $\mu$ A at room temperature. The input offset voltage is typically 3mV when operating above  $V^+$ . The LT1784 will operate with inputs 18V above  $V^-$  regardless of  $V^+$ .

The inputs are protected against excursions as much as 10V below  $V^-$  by an internal 1k resistor in series with each input and a diode from the input to the negative supply. The input stage of the LT1784 incorporates phase reversal protection to prevent the output from phase reversing for inputs up to 9V below  $V^-$ . There are no clamping diodes between the inputs and the maximum differential input voltage is 18V.

### Output

The output of the LT1784 can swing to within 80mV of the positive rail and within 4mV of the negative rail with no load. When monitoring input voltages within 80mV of the positive rail or within 4mV of the negative rail, gain should be taken to keep the output from clipping. The LT1784 can typically sink and source over 25mA at  $\pm 5$ V supplies, sourcing current is reduced to 7.5mA at 3V total supplies as noted in the Electrical Characteristics section.

The LT1784 is internally compensated to drive at least 400pF of capacitance under any output loading conditions. A 0.22 $\mu$ F capacitor in series with a 150 $\Omega$  resistor between the output and ground will compensate these amplifiers for larger capacitive loads, up to 10,000pF at all output currents.

### Distortion

There are two main contributors to distortion in op amps: output crossover distortion as the output transitions from sourcing to sinking current, and distortion caused by non-linear common mode rejection. If the op amp is operating inverting, there is no common mode induced distortion. If the op amp is operating in the PNP input stage (input not within 1V of  $V^+$ ), the CMRR is very good, typically 95dB. When the LT1784 switches between input stages, there is significant nonlinearity in the CMRR. Lower load resistance increases the output crossover distortion but has no effect on the input stage transition distortion. For lowest distortion, the LT1784 should be operated single supply, with the output always sourcing current and with the input voltage swing between ground and ( $V^+ - 1$ V). See Typical Performance Characteristics curve, “Total Harmonic Distortion + Noise vs Output Voltage Amplitude.”

### Gain

The open-loop gain is almost independent of load when the output is sourcing current. This optimizes performance in single supply applications where the load is returned to ground. The Typical Performance Characteristic curve “Open-Loop Gain” for various loads shows the details.

## APPLICATIONS INFORMATION

### Shutdown

The 6-lead part includes a shutdown feature that disables the part, reducing quiescent current and making the output high impedance. The part can be shut down by bringing

the SHDN pin 1.2V or more above  $V^-$ . When shut down, the supply current is less than  $1\mu\text{A}$  ( $V^- \leq V_{\text{OUT}} \leq V^+$ ). In normal operation, the SHDN pin can be tied to  $V^-$  or left floating. See Typical Performance Characteristics curve, "Supply Current vs SHDN pin Voltage."

## TYPICAL APPLICATIONS

### Negative Rectifier

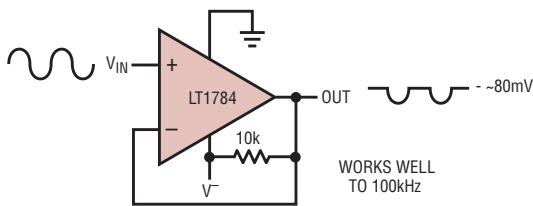

### Adjustable Clamp

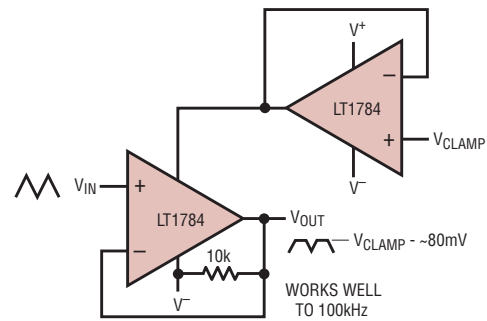

1784 TA02

## SIMPLIFIED SCHEMATIC

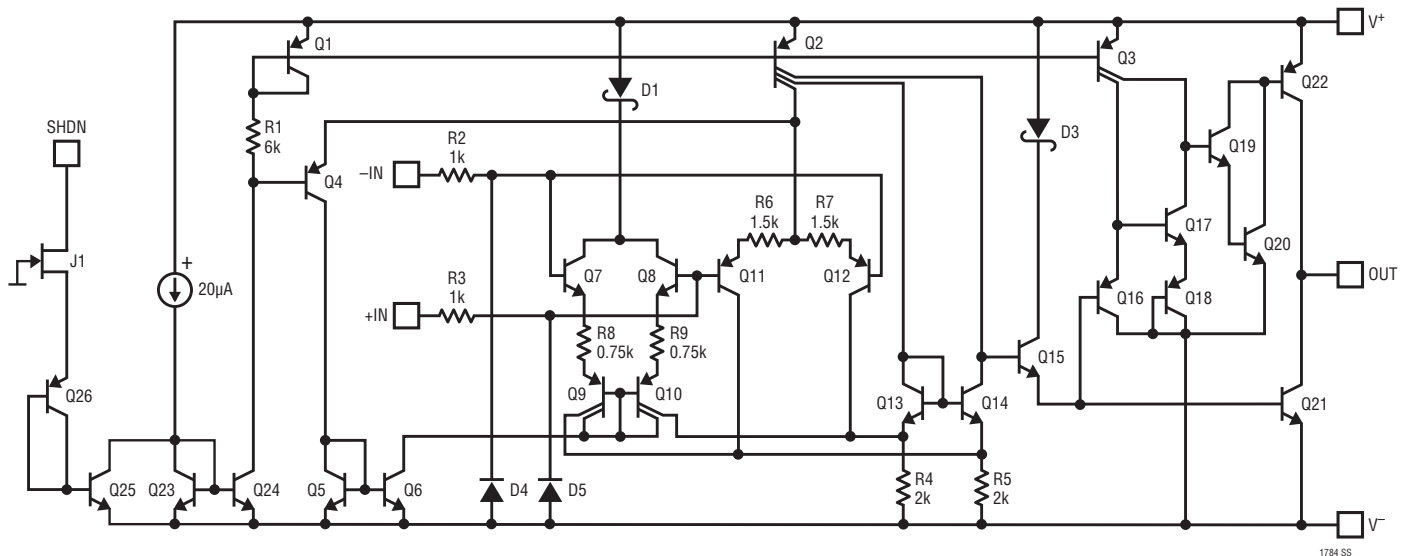

1784 SS

# PACKAGE DESCRIPTION

## S5 Package 5-Lead Plastic TSOT-23

(Reference LTC DWG # 05-08-1635 Rev B)

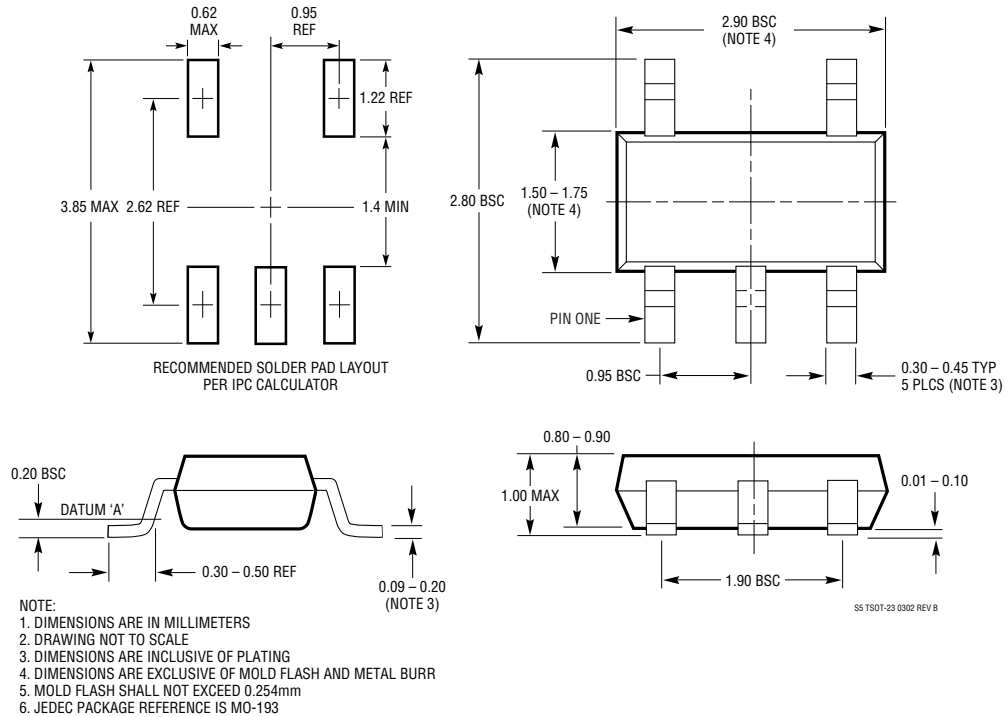

## S6 Package 6-Lead Plastic TSOT-23

(Reference LTC DWG # 05-08-1636 Rev B)

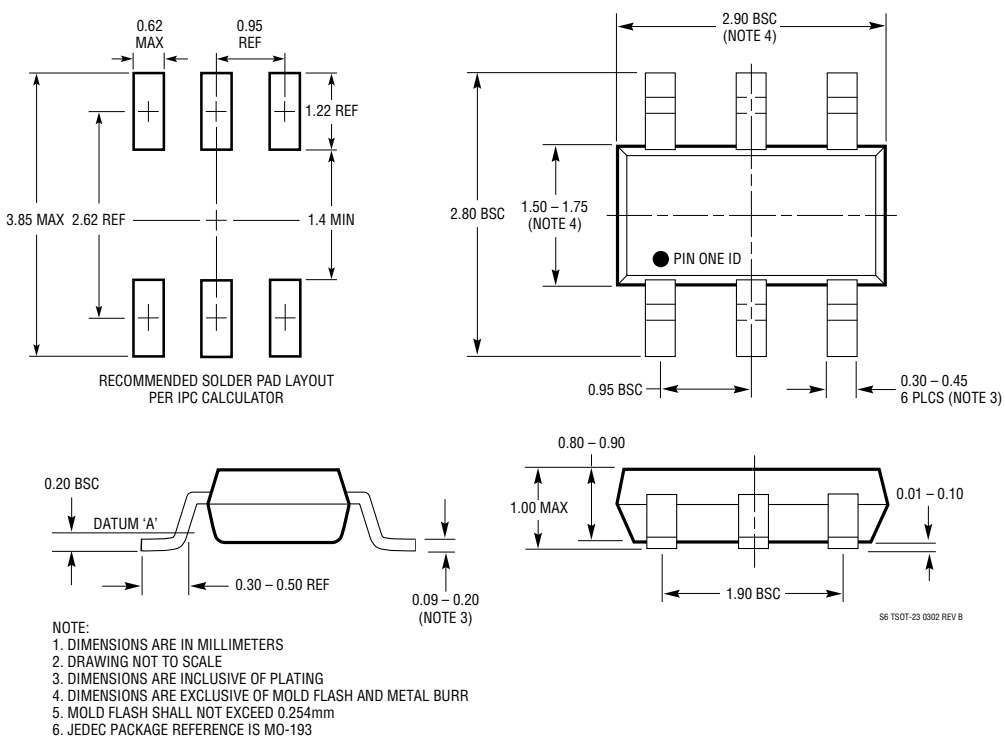

## TYPICAL APPLICATIONS

### Protected Fault Conditions

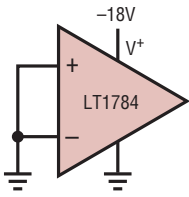

REVERSE BATTERY

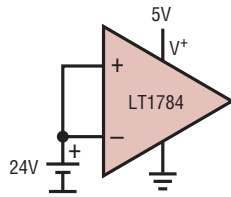

INPUT OVERVOLTAGE

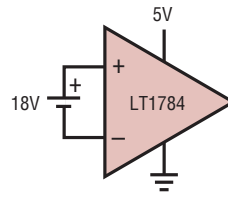

INPUT DIFFERENTIAL VOLTAGE

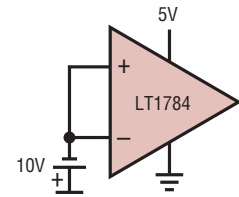

INPUTS BELOW GROUND

### Simple Peak Detector

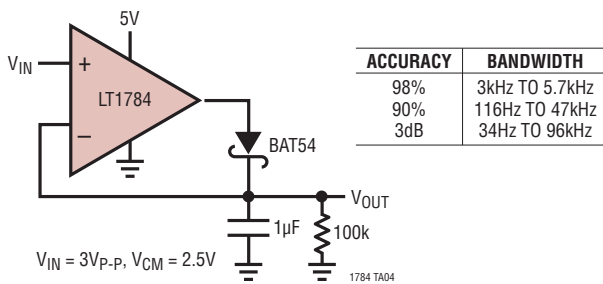

### Simple Supply Full Wave Rectifier

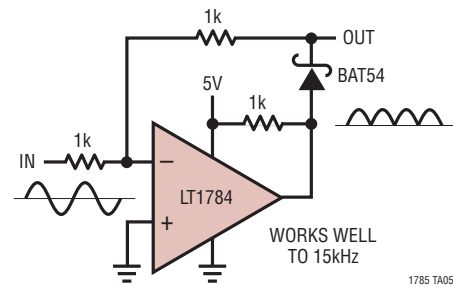

### Simple Polarity Selector

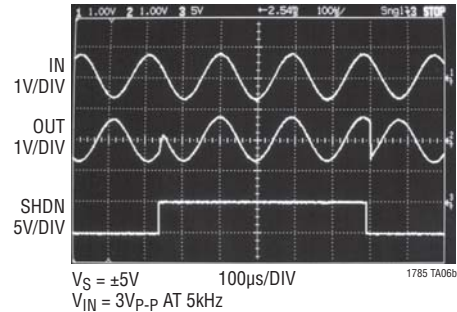
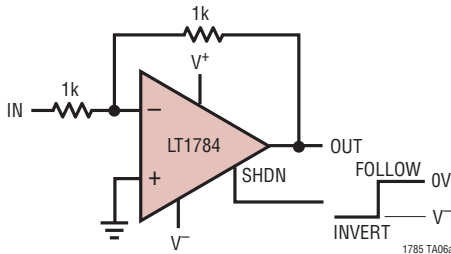

## RELATED PARTS

PART NUMBER	DESCRIPTION	COMMENTS
LT1782	Micropower Over-The-Top Rail-to-Rail In/Out Op Amp in SOT-23	55µA Max Supply Current, 800µV Max Offset Voltage
LT1783	1.25MHz Over-The-Top Rail-to-Rail In/Out Op Amp in SOT-23	300µA Max Supply Current, 800µV Max Offset Voltage
LT1797	10MHz Rail-to-Rail In/Out Op Amp in SOT-23	Unity-Gain Stable, 2.25µV/µs Slew Rate
LT1637	1.1MHz Over-The-Top Rail-to-Rail In/Out Op Amp	Micropower, 0.4V/µs Slew Rate
LT1638/LT1639	Dual/Quad 1.2MHz Over-The-Top Rail-to-Rail In/Out Op Amp	Micropower 230µA Max, 0.4V/µs Slew Rate
LT1880	SOT-23 Pico Amp Input, Precision, Rail-to-Rail Output Op Amp	150µV Offset, 900pA Bias Current