

FEATURES

- Inherently Matched LED Current
- Drives Up to Six LEDs from a 3.6V Supply
- No External Schottky Diode Required
- 1.2MHz Switching Frequency (LT3465)
- 2.4MHz Switching Frequency Above AM Broadcast Band (LT3465A)
- V_{IN} Range: 2.7V to 16V
- $V_{OUT(MAX)} = 30V$
- Automatic Soft-Start (LT3465)
- Open LED Protection
- High Efficiency: 81% (LT3465) 79% (LT3465A) Typical
- Requires Only 0.22 μ F Output Capacitor
- Low Profile (1mm) SOT-23

APPLICATIONS

- Cellular Phones
- PDAs, Handheld Computers
- Digital Cameras
- MP3 Players
- GPS Receivers

DESCRIPTION

The LT[®]3465/LT3465A are step-up DC/DC converters designed to drive up to six LEDs in series from a Li-Ion cell. Series connection of the LEDs provides identical LED currents and eliminates the need for ballast resistors. These devices integrate the Schottky diode required externally on competing devices. Additional features include output voltage limiting when LEDs are disconnected, one-pin shutdown and dimming control. The LT3465 has internal soft-start.

The LT3465 switches at 1.2MHz, allowing the use of tiny external components. The faster LT3465A switches at 2.4MHz. Constant frequency switching results in low input noise and a small output capacitor. Just 0.22 μ F is required for 3-, 4- or 5-LED applications.

The LT3465 and LT3465A are available in the low profile (1mm) 6-lead SOT-23 (ThinSOT[™]) package.

LT, LTC and LT are registered trademarks of Linear Technology Corporation. ThinSOT is a trademark of Linear Technology Corporation. All other trademarks are the property of their respective owners.

TYPICAL APPLICATION

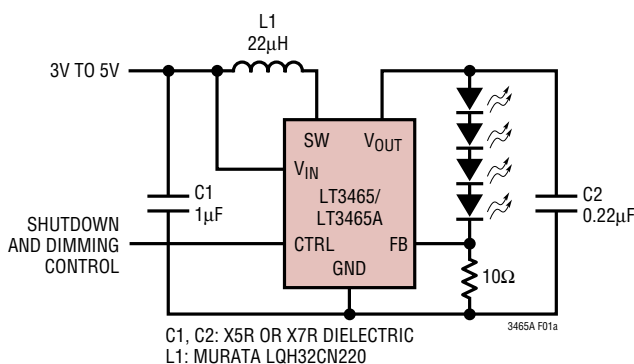
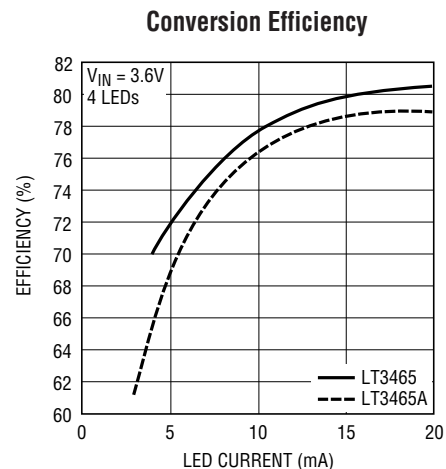

Figure 1. Li-Ion Powered Driver for Four White LEDs



3465A F01b

LT3465/LT3465A

ABSOLUTE MAXIMUM RATINGS

(Note 1)

Input Voltage (V_{IN})	16V
SW Voltage	36V
FB Voltage	2V
CTRL Voltage	10V
Operating Temperature Range (Note 2) ..	-40°C to 85°C
Maximum Junction Temperature	125°C
Storage Temperature Range	-65°C to 150°C
Lead Temperature (Soldering, 10 sec).....	300°C

PACKAGE/ORDER INFORMATION

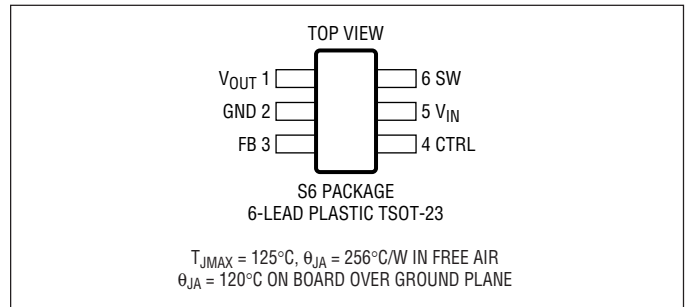

ORDER PART NUMBER	S6 PART MARKING
LT3465ES6	LTH2
LT3465AES6	LTAFT

Order Options Tape and Reel: Add #TR
 Lead Free: Add #PBF Lead Free Tape and Reel: Add #TRPBF
 Lead Free Part Marking: <http://www.linear.com/leadfree/>

Consult LTC Marketing for parts specified with wider operating temperature ranges.

ELECTRICAL CHARACTERISTICS

The ● denotes the specifications which apply over the full operating temperature range, otherwise specifications are at $T_A = 25^\circ\text{C}$. $V_{IN} = 3\text{V}$, $V_{CTRL} = 3\text{V}$, unless otherwise noted.

PARAMETER	CONDITIONS	LT3465			LT3465A			UNITS
		MIN	TYP	MAX	MIN	TYP	MAX	
Minimum Operating Voltage		2.7			2.7			V
Maximum Operating Voltage				16			16	V
Feedback Voltage	$0^\circ\text{C} \leq T_A \leq 85^\circ\text{C}$	188	200	212	188	200	212	mV
FB Pin Bias Current		10	35	100	10	35	100	nA
Supply Current	Not Switching CTRL = 0V	1.9	2.6	3.3	1.9	2.6	3.3	mA
		2.0	3.2	5.0	2.0	3.2	5.0	μA
Switching Frequency		0.8	1.2	1.6	1.8	2.4	2.8	MHz
Maximum Duty Cycle		● 90	93		90	93		%
Switch Current Limit		● 225	340		225	340		mA
Switch V_{CESAT}	$I_{SW} = 250\text{mA}$		300			300		mV
Switch Leakage Current	$V_{SW} = 5\text{V}$		0.01	5		0.01	5	μA
V_{CTRL} for Full LED Current			1.8		1.8			V
V_{CTRL} to Enable Chip		● 150			150			mV
V_{CTRL} to Shut Down Chip		●		50			50	mV
CTRL Pin Bias Current	$T_A = 85^\circ\text{C}$	48	60	72	48	60	72	μA
	$T_A = -40^\circ\text{C}$	40	50	60	40	50	60	μA
		60	75	90	60	75	90	μA
Soft-Start Time			600					μs
Schottky Forward Drop	$I_D = 150\text{mA}$		0.7		0.7			V
Schottky Leakage Current	$V_R = 30\text{V}$			4			4	μA

Note 1: Absolute Maximum Ratings are those values beyond which the life of a device may be impaired.

Note 2: The LT3465E/LT3465AE are guaranteed to meet performance

specifications from 0°C to 70°C. Specifications over the -40°C to 85°C operating temperature range are assured by design, characterization and correlation with statistical process controls.

TYPICAL PERFORMANCE CHARACTERISTICS

Switch Saturation Voltage (V_{CESAT})

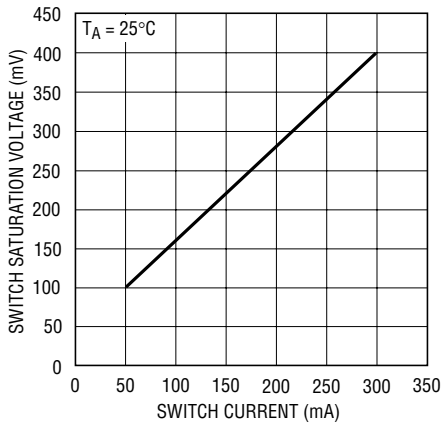

3465A G01

Schottky Forward Voltage Drop

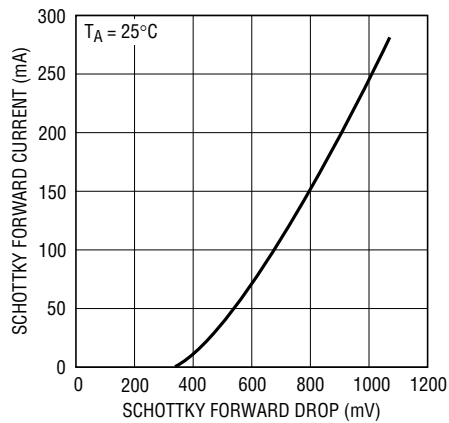

3465A G02

Shutdown Quiescent Current ($CTRL = 0V$)

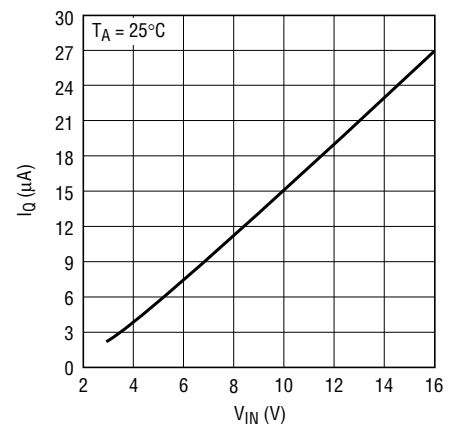

3465A G03

V_{FB} vs V_{CTRL}

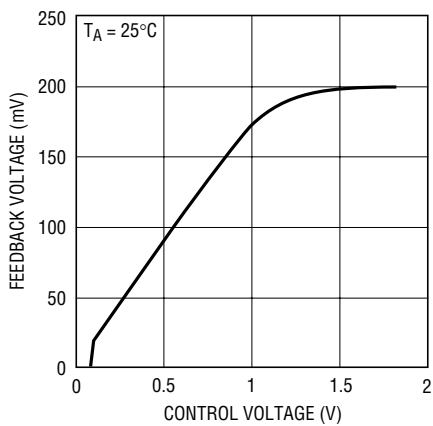

3465A G04

Open-Circuit Output Clamp Voltage

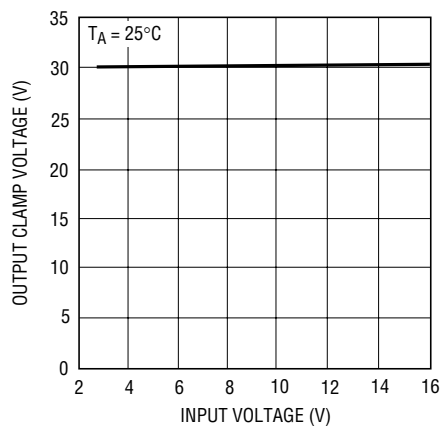

3465A G05

Input Current in Output Open Circuit

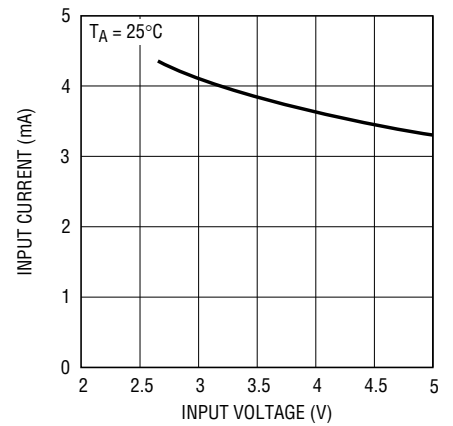

3465A G06

Switching Waveforms (LT3465)

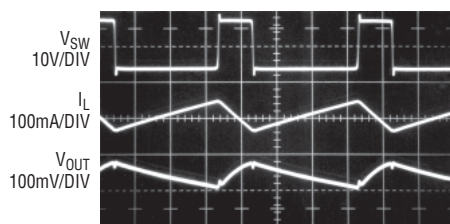

$V_{IN} = 3.6V$
4 LEDs
20mA, 22µH

200ns/DIV

3465A G07a

Switching Waveforms (LT3465A)

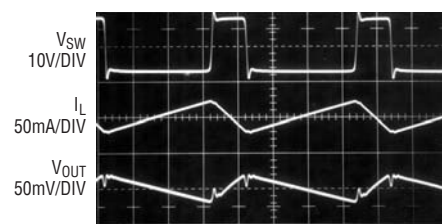

$V_{IN} = 3.6V$
4 LEDs
20mA, 22µH

100ns/DIV

3465A G07b

Switching Frequency

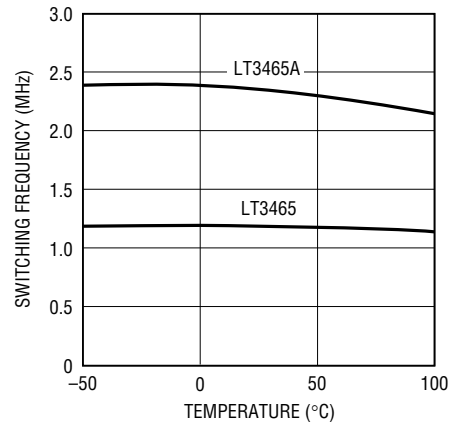

4365A G08

TYPICAL PERFORMANCE CHARACTERISTICS

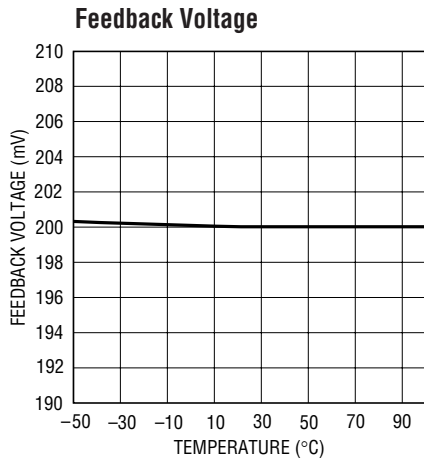

3465A G09

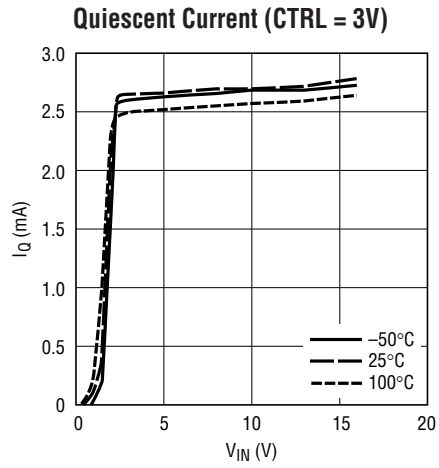

3465A G10

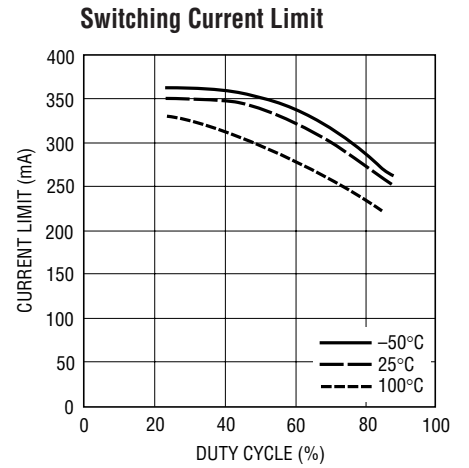

3465A G11

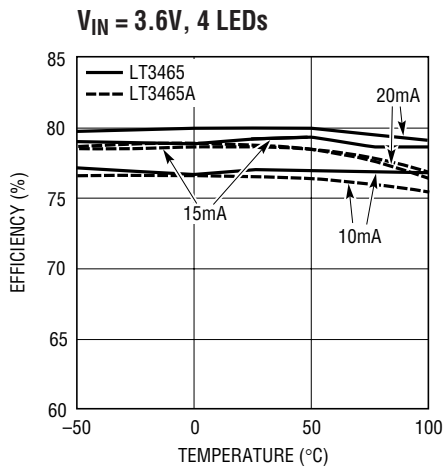

3465A G12

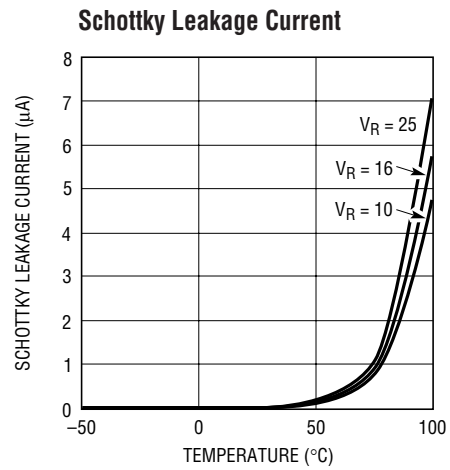

3465A G13

PIN FUNCTIONS

V_{OUT} (Pin 1): Output Pin. Connect to output capacitor and LEDs. Minimize trace between this pin and output capacitor to reduce EMI.

GND (Pin 2): Ground Pin. Connect directly to local ground plane.

FB (Pin 3): Feedback Pin. Reference voltage is 200mV. Connect LEDs and a resistor at this pin. LED current is determined by the resistance and CTRL pin voltage:

CTRL (Pin 4): Dimming Control and Shutdown Pin. Ground this pin to shut down the device. When V_{CTRL} is greater than about 1.8V, full-scale LED current is generated. When V_{CTRL} is less than 1V, LED current is reduced. Floating this pin places the device in shutdown mode.

V_{IN} (Pin 5): Input Supply Pin. Must be locally bypassed with a 1 μ F X5R or X7R type ceramic capacitor.

SW (Pin 6): Switch Pin. Connect inductor here.

$$I_{LED} = \frac{1}{R_{FB}} \cdot \left(200\text{mV} - 26\text{mV} \cdot \ln \left(\frac{\exp\left(\frac{200\text{mV}}{26\text{mV}}\right)}{\exp\left(\frac{V_{CTRL}(\text{mV})}{5\text{mV} \cdot 26\text{mV}}\right)} + 1 \right) \right) \text{ for } V_{CTRL} > 150\text{mV}$$

BLOCK DIAGRAM

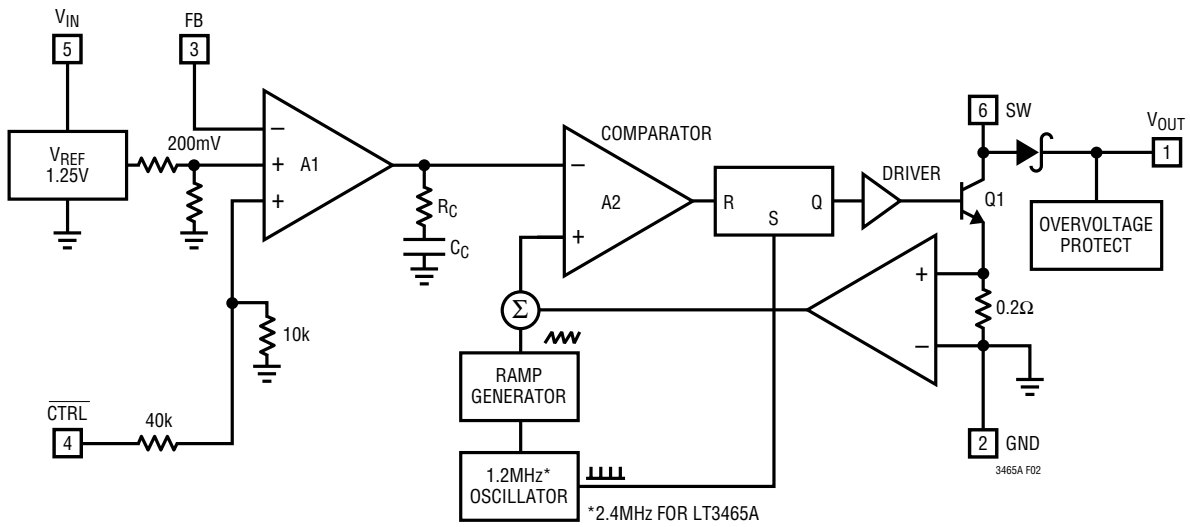

Figure 2. LT3465 Block Diagram

APPLICATIONS INFORMATION

Operation

The LT3465 uses a constant frequency, current mode control scheme to provide excellent line and load regulation. Operation can be best understood by referring to the block diagram in Figure 2. At the start of each oscillator cycle, the SR latch is set, which turns on the power switch Q1. A voltage proportional to the switch current is added to a stabilizing ramp and the resulting sum is fed into the positive terminal of the PWM comparator A2. When this voltage exceeds the level at the negative input of A2, the SR latch is reset turning off the power switch. The level at the negative input of A2 is set by the error amplifier A1, and is simply an amplified version of the difference between the feedback voltage and the reference voltage of 200mV. In this manner, the error amplifier sets the correct peak current level to keep the output in regulation. If the error amplifier's output increases, more current is delivered to the output; if it decreases, less current is delivered. The CTRL pin voltage is used to adjust the reference voltage. The block diagram for the LT3465A (not shown) is identical except that the oscillator frequency is 2.4MHz.

Minimum Output Current

The LT3465 can drive a 3-LED string at 1.5mA LED current without pulse skipping. As current is further reduced, the device will begin skipping pulses. This will result in some low frequency ripple, although the LED current remains regulated on an average basis down to zero. The photo in Figure 3a details circuit operation driving three white LEDs at a 1.5mA load. Peak inductor current is less than 40mA and the regulator operates in discontinuous mode, meaning the inductor current reaches zero during the discharge phase. After the inductor current reaches zero, the SW pin exhibits ringing due to the LC tank circuit formed by the inductor in combination with switch and diode capacitance. This ringing is not harmful; far less spectral energy is contained in the ringing than in the switch transitions. The ringing can be damped by application of a 300Ω resistor across the inductor, although this will degrade efficiency. Because of the higher switching frequency, the LT3465A can drive a 3-LED string at 0.2mA LED current without pulse

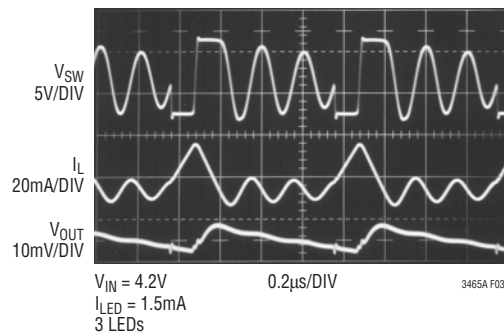

Figure 3a. Switching Waveforms (LT3465)

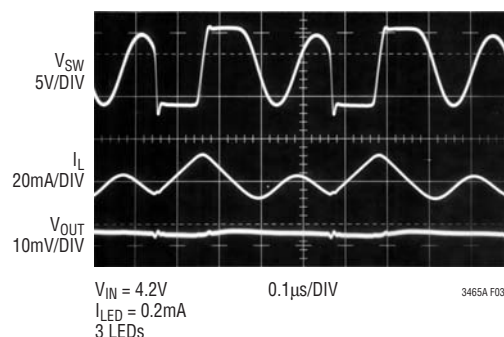

Figure 3b. Switching Waveforms (LT3465A)

APPLICATIONS INFORMATION

skipping using a 1k resistor from FB to GND. The photo in Figure 3b details circuit operation driving three white LEDs at a 0.2mA load. Peak inductor current is less than 30mA.

Inductor Selection

A 22μH inductor is recommended for most LT3465 applications. Although small size and high efficiency are major concerns, the inductor should have low core losses at 1.2MHz and low DCR (copper wire resistance). Some inductors in this category with small size are listed in Table 1. The efficiency comparison of different inductors is shown in Figure 4a. A 22μH or 10μH inductor is recommended for most LT3465A applications. The inductor should have low core losses at 2.4MHz and low DCR. The efficiency comparison of different inductors is shown in figure 4b.

Table 1. Recommended Inductors

PART NUMBER	DCR (Ω)	CURRENT RATING (mA)	MANUFACTURER
LQH32CN220	0.71	250	Murata
LQH2MCN220	2.4	185	814-237-1431 www.murata.com
ELJPC220KF	4.0	160	Panasonic
			714-373-7334 www.panasonic.com
CDRH3D16-220	0.53	350	Sumida
			847-956-0666 www.sumida.com
LB2012B220M	1.7	75	Taiyo Yuden
			408-573-4150 www.t-yuden.com
LEM2520-220	5.5	125	Taiyo Yuden
			408-573-4150 www.t-yuden.com

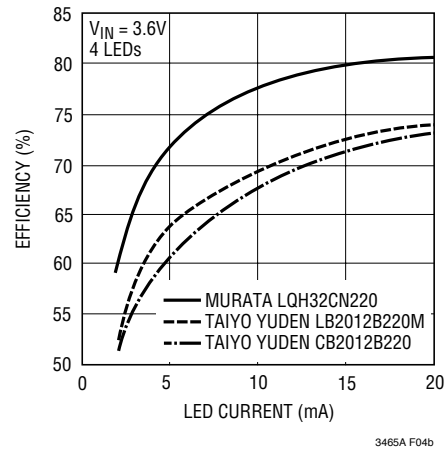

Figure 4a. Efficiency Comparison of Different Inductors (LT3465)

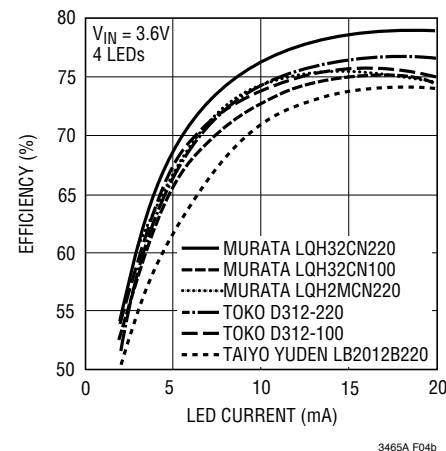

Figure 4b. Efficiency Comparison of Different Inductors (LT3465A)

Capacitor Selection

The small size of ceramic capacitors makes them ideal for LT3465 and LT3465A applications. X5R and X7R types are recommended because they retain their capacitance over wider voltage and temperature ranges than other types such as Y5V or Z5U. A 1μF input capacitor and a 0.22μF output capacitor are sufficient for most LT3465 and LT3465A applications.

Table 2. Recommended Ceramic Capacitor Manufacturers

MANUFACTURER	PHONE	URL
Taiyo Yuden	408-573-4150	www.t-yuden.com
Murata	814-237-1431	www.murata.com
Kemet	408-986-0424	www.kemet.com

APPLICATIONS INFORMATION

Soft-Start (LT3465)

The LT3465 has an internal soft-start circuit to limit the input current during circuit start-up. The circuit start-up waveforms are shown in Figure 5.

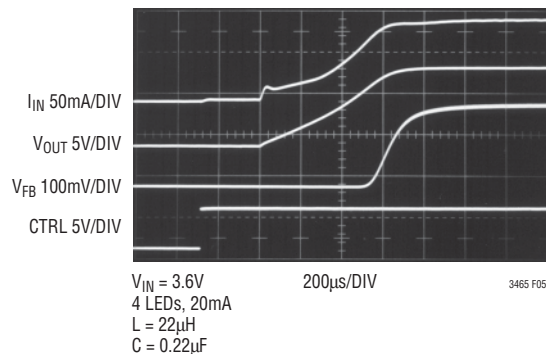

Figure 5. Start-Up Waveforms

Inrush Current

The LT3465 and LT3465A have a built-in Schottky diode. When supply voltage is applied to the V_{IN} pin, the voltage difference between V_{IN} and V_{OUT} generates inrush current flowing from input through the inductor and the Schottky diode to charge the output capacitor to V_{IN} . The maximum current the Schottky diode in the LT3465 and LT3465A can sustain is 1A. The selection of inductor and capacitor value should ensure the peak of the inrush current to be below 1A. The peak inrush current can be calculated as follows:

$$I_P = \frac{V_{IN} - 0.6}{L \cdot \omega} \cdot \exp\left[-\frac{\alpha}{\omega} \cdot \arctan\left(\frac{\omega}{\alpha}\right)\right] \cdot \sin\left[\arctan\left(\frac{\omega}{\alpha}\right)\right]$$

$$\alpha = \frac{r + 1.5}{2 \cdot L}$$

$$\omega = \sqrt{\frac{1}{L \cdot C} - \frac{(r + 1.5)^2}{4 \cdot L^2}}$$

where L is the inductance, r is the resistance of the inductor and C is the output capacitance. For low DCR

inductors, which is usually the case for this application, the peak inrush current can be simplified as follows:

$$I_P = \frac{V_{IN} - 0.6}{L \cdot \omega} \cdot \exp\left(-\frac{\alpha}{\omega} \cdot \frac{\pi}{2}\right)$$

Table 3 gives inrush peak currents for some component selections.

Table 3. Inrush Peak Current

V_{IN} (V)	r (Ω)	L (μ H)	C (μ F)	I_P (A)
5	0.5	22	0.22	0.38
5	0.5	22	1	0.70
3.6	0.5	22	0.22	0.26
5	0.5	33	1	0.60

LED Current and Dimming Control

The LED current is controlled by the feedback resistor (R_1 in Figure 1) and the feedback reference voltage.

$$I_{LED} = V_{FB}/R_{FB}$$

The CTRL pin controls the feedback reference voltage as shown in the Typical Performance Characteristics. For CTRL higher than 1.8V, the feedback reference is 200mV, which results in full LED current. CTRL pin can be used as dimming control when CTRL voltage is between 200mV to 1.5V. In order to have accurate LED current, precision resistors are preferred (1% is recommended). The formula and table for R_{FB} selection are shown below.

$$R_{FB} = 200\text{mV}/I_{LED-Full} \quad (1)$$

Table 4. R_{FB} Resistor Value Selection

FULL I_{LED} (mA)	R_1 (Ω)
5	40.0
10	20.0
15	13.3
20	10.0

The filtered PWM signal can be considered to be an adjustable DC voltage. It can be used to adjust the CTRL voltage source in dimming control. The circuit is shown in Figure 6. The corner frequency of R_1 and C_1 should be

APPLICATIONS INFORMATION

lower than the frequency of the PWM signal. R1 needs to be much smaller than the internal impedance in the CTRL pin, which is 50kΩ. A 5k resistor is suggested.

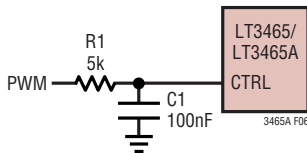

Figure 6. Dimming Control Using a Filtered PWM Signal

Dimming Using Direct PWM (LT3465A)

Unlike the LT3465, the LT3465A does not have internal soft-start. Although the input current is higher during start-up, the absence of soft-start allows the CTRL pin to be directly driven with a PWM signal for dimming. A zero

percent duty cycle sets the LED current to zero, while 100% duty cycle sets it to full current. Average LED current increases proportionally with the duty cycle of the PWM signal. With the PWM signal at the CTRL pin to turn the LT3465A on and off, the output capacitor is charged and discharged accordingly. This capacitor charging/discharging affects the waveform at the FB pin. For low PWM frequencies the output capacitor charging/discharging time is a very small portion in a PWM period. The average FB voltage increases linearly with the PWM duty cycle. As the PWM frequency increases, the capacitor charging/discharging has a larger effect on the linearity of the PWM control. Waveforms for a 1kHz and 10kHz PWM CTRL signals are shown in Figures 7a and 7b respectively. The capacitor charging/discharging has a larger effect on the FB waveform in the 10kHz case than that in the 1kHz

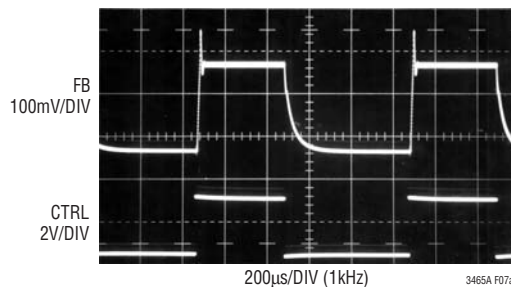
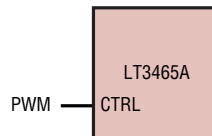

Figure 7a.

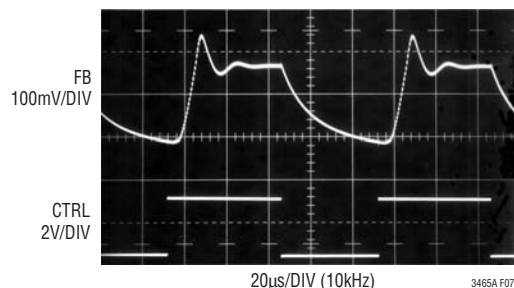

Figure 7b.

APPLICATIONS INFORMATION

case. The Average FB Voltage vs PWM Duty Cycle curves of different PWM frequencies with different output capacitors are shown in Figures 7c and 7d respectively. For PWM frequency lower than 1kHz, the curves are almost linear. For PWM frequency higher than 10kHz, the curves show strong nonlinearity. Since the cause of the nonlinearity is the output capacitor charging/discharging, the output capacitance and output voltage also affect

the nonlinearity in the high PWM frequencies. Because smaller capacitance corresponds to shorter capacitor charging/discharging time, the smaller output capacitance has better linearity as shown in Figures 7c and 7d. Figures 7e and 7f show the output voltage's effect to the curves. The PWM signal should be at least 1.8V in magnitude; lower voltage will lower the feedback voltage as shown in Equation 1.

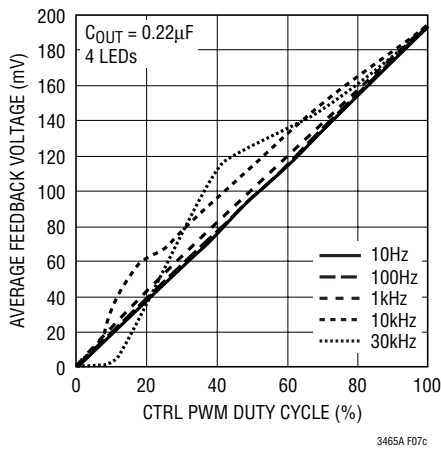

Figure 7c. V_{FB} vs CTRL PWM Duty Cycle

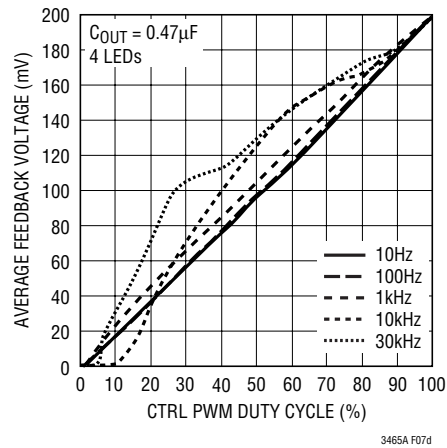

Figure 7d. V_{FB} vs CTRL PWM Duty Cycle

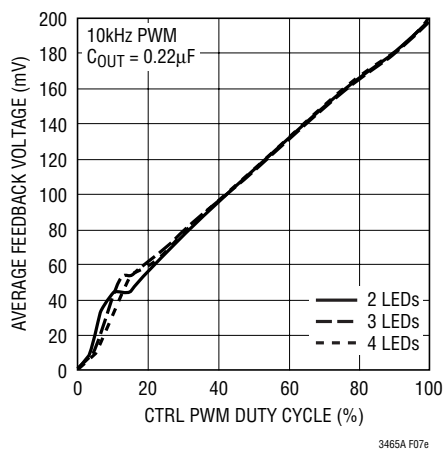

Figure 7e. V_{FB} vs CTRL PWM Duty Cycle

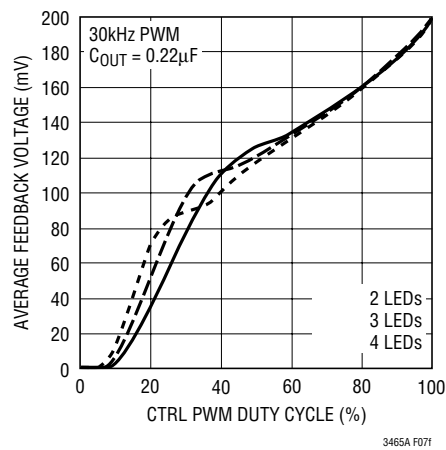

Figure 7f. V_{FB} vs CTRL PWM Duty Cycle

APPLICATIONS INFORMATION

Open-Circuit Protection

The LT3465 and LT3465A have an internal open-circuit protection circuit. In the cases of output open circuit, when the LEDs are disconnected from the circuit or the LEDs fail, the V_{OUT} is clamped at 30V. The LT3465 and LT3465A will then switch at a very low frequency to minimize the input current. V_{OUT} and input current during output open circuit are shown in the Typical Performance Characteristics.

Board Layout Consideration

As with all switching regulators, careful attention must be paid to the PCB board layout and component placement. To maximize efficiency, switch rise and fall times are made as short as possible. To prevent electromagnetic interference (EMI) problems, proper layout of the high frequency switching path is essential. Place C_{OUT} next to the V_{OUT} and GND pins. Always use a ground plane under the switching regulator to minimize interplane coupling. In addition, the ground connection for the feedback

resistor R1 should be tied directly to the GND pin and not shared with any other component, ensuring a clean, noise-free connection. Recommended component placement is shown in Figure 8.

Start-Up Input Current (LT3465A)

As previously mentioned, the LT3465A does not have an internal soft-start circuit. Inrush current can therefore rise to approximately 400mA as shown in Figure 9 when driving 4 LEDs. The LT3465 has an internal soft-start circuit and is recommended if inrush current must be minimized.

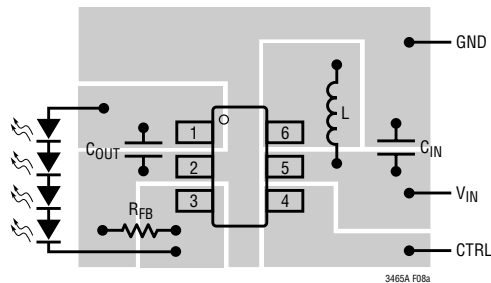

Figure 8. Recommended Component Placement.

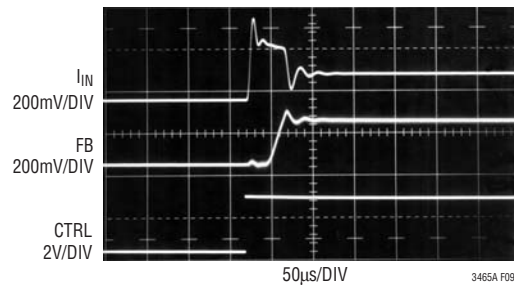
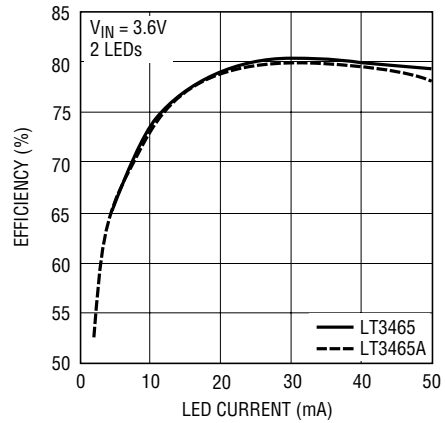
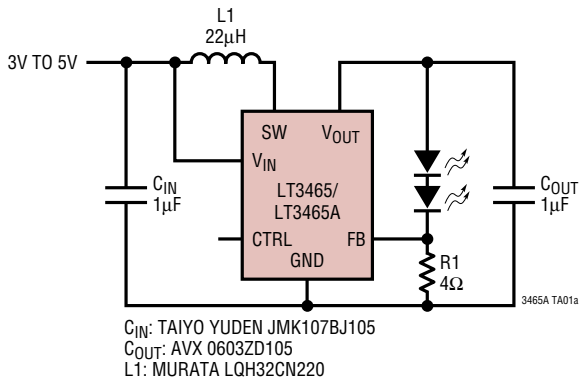

Figure 9.

TYPICAL APPLICATIONS

Li-Ion to Two White LEDs



Li-Ion to Three White LEDs

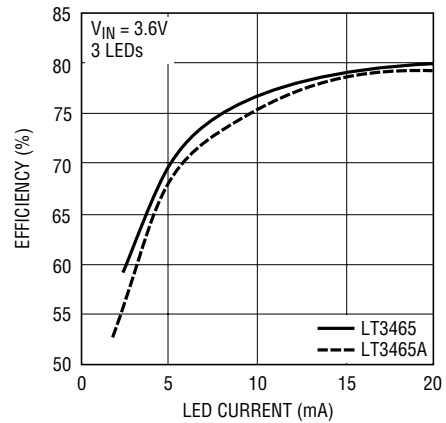
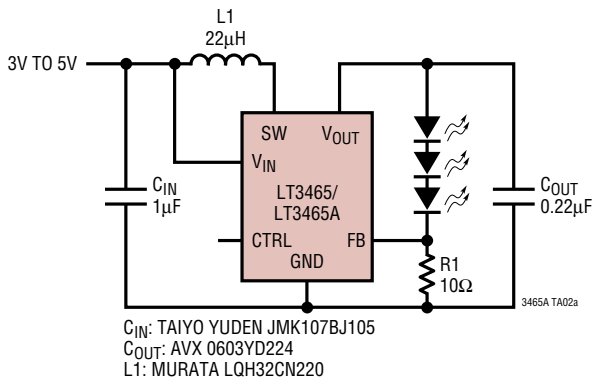

TYPICAL APPLICATION

Li-Ion to Five White LEDs

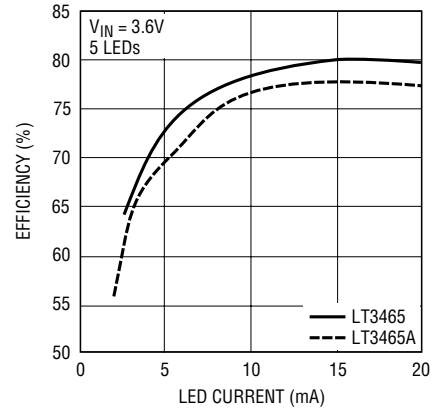
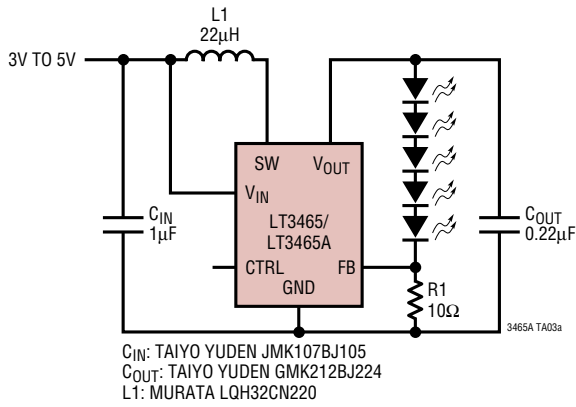

3465A TA03b

PACKAGE DESCRIPTION

S6 Package
6-Lead Plastic TSOT-23
 (Reference LTC DWG # 05-08-1636)

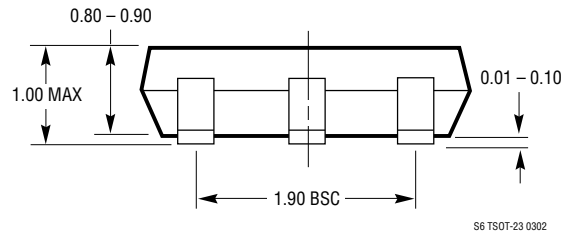
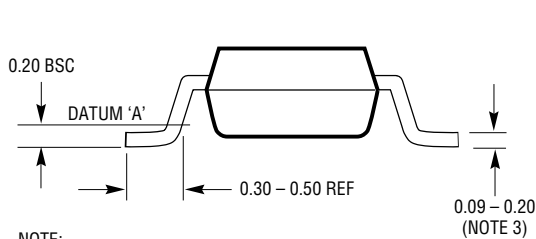
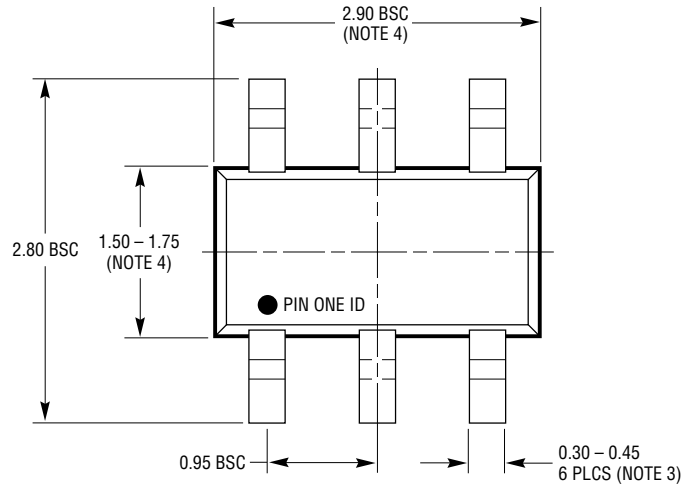
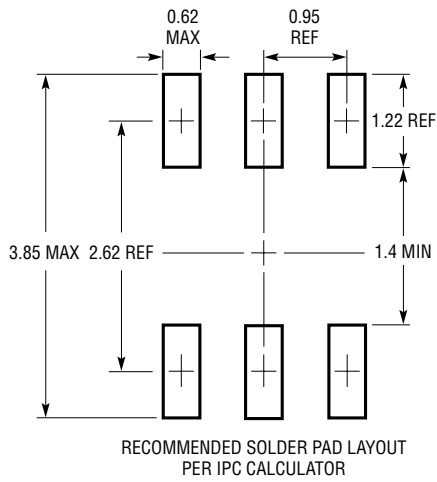

- NOTE:
1. DIMENSIONS ARE IN MILLIMETERS
 2. DRAWING NOT TO SCALE
 3. DIMENSIONS ARE INCLUSIVE OF PLATING
 4. DIMENSIONS ARE EXCLUSIVE OF MOLD FLASH AND METAL BURR
 5. MOLD FLASH SHALL NOT EXCEED 0.254mm
 6. JEDEC PACKAGE REFERENCE IS MO-193

TYPICAL APPLICATION

Li-Ion to Six White LEDs

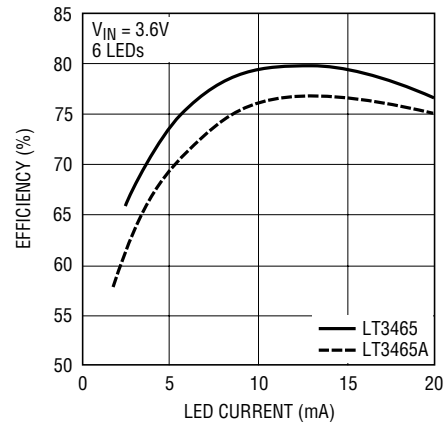
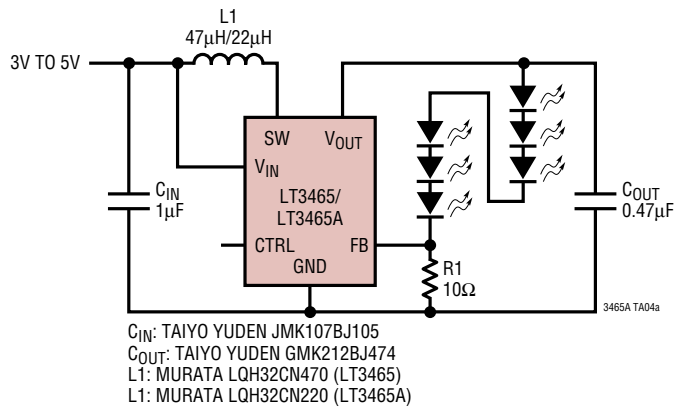

RELATED PARTS

PART NUMBER	DESCRIPTION	COMMENTS
LT1618	Constant Current, Constant Voltage, 1.4MHz, High Efficiency Boost Regulator	Up to 16 White LEDs, V_{IN} : 1.6V to 18V, $V_{OUT(MAX)}$: 34V, I_Q : 1.8mA, I_{SHDN} : <1µA, 10-Lead MS Package
LT1932	Constant Current, 1.2MHz, High Efficiency White LED Boost Regulator	Up to 8 White LEDs, V_{IN} : 1V to 10V, $V_{OUT(MAX)}$: 34V, I_Q : 1.2mA, I_{SHDN} : <1µA, ThinSOT Package
LT1937	Constant Current, 1.2MHz, High Efficiency White LED Boost Regulator	Up to 4 White LEDs, V_{IN} : 2.5V to 10V, $V_{OUT(MAX)}$: 34V, I_Q : 1.9mA, I_{SHDN} : <1µA, ThinSOT
LTC®3200-5	Low Noise, 2MHz, Regulated Charge Pump White LED Driver	Up to 6 White LEDs, V_{IN} : 2.7V to 4.5V, I_Q : 8mA, I_{SHDN} : <1µA, ThinSOT Package
LTC3202	Low Noise, 1.5MHz, Regulated Charge Pump White LED Driver	Up to 8 White LEDs, V_{IN} : 2.7V to 4.5V, I_Q : 5mA, I_{SHDN} : <1µA, 10-Lead MS Package
LTC3205	Multi-Display LED Controller	92% Efficiency, V_{IN} : 2.8V to 4.5V, I_Q : 4.2mA, I_{SD} : <1µA, Drives Main, Sub, RGB, QFN Package
LTC3405 LTC3405A	300mA (I_{OUT}), 1.5MHz Synchronous Step-Down DC/DC Converter	95% Efficiency, V_{IN} : 2.7V to 6V, $V_{OUT(MIN)}$: 0.8V, I_Q : 20µA, I_{SHDN} : <1µA, ThinSOT Package
LTC3406 LTC3406B	600mA (I_{OUT}), 1.5MHz Synchronous Step-Down DC/DC Converter	95% Efficiency, V_{IN} : 2.5V to 5.5V, $V_{OUT(MIN)}$: 0.6V, I_Q : 20µA, I_{SHDN} : <1µA, ThinSOT Package
LTC3407	Dual 600mA (I_{OUT}), 1.5MHz Synchronous Step-Down DC/DC Converters	95% Efficiency, V_{IN} : 2.5V to 5.5V, $V_{OUT(MIN)}$: 0.6V, I_Q : 40µA, I_{SHDN} : <1µA, MS10E, DFN Package
LTC3411	1.25A (I_{OUT}), 4MHz Synchronous Step-Down DC/DC Converter	95% Efficiency, V_{IN} : 2.5V to 5.5V, $V_{OUT(MIN)}$: 0.8V, I_Q : 60µA, I_{SHDN} : <1µA, MS10, DFN Package
LTC3412	2.5A (I_{OUT}), 4MHz Synchronous Step-Down DC/DC Converter	95% Efficiency, V_{IN} : 2.5V to 5.5V, $V_{OUT(MIN)}$: 0.8V, I_Q : 60µA, I_{SHDN} : <1µA, TSSOP16E Package
LTC3440/ LTC3441	600mA/1.2A (I_{OUT}), 2MHz/1MHz Synchronous Buck-Boost DC/DC Converter	95% Efficiency, V_{IN} : 2.5V to 5.5V, $V_{OUT(MIN)}$: 2.5V, I_Q : 25µA, I_{SHDN} : <1µA, 10-Lead MS Package
LT3466	Full Function White LED Step-Up Converter with Built-In Schottkys	Drives Up to 20 LEDs, Independent Step-Up Converters, V_{IN} : 2.7µV to 24V, DFN Package