

## FEATURES

- 4.5V to 45V Input Supply Range
- Up to 50mA LED Current per Channel
- 100mA, 45V Internal Switches
- 8% Relative LED Current Match at 20mA
- 16 Independent LED Channels
- 5000:1 True Color PWM™ Dimming Range
- LEDs Disconnected in Shutdown
- Internal Schottky Diodes
- Low Quiescent Current
- 2MHz Switching Frequency
- R<sub>SET</sub> Pin Sets Master LED Current
- Typical Efficiency: 92%
- Open LED Detection and Thermal Protection
- 56-Pin 5mm × 9mm × 0.75mm QFN Package

## APPLICATIONS

- LED Video Billboards
- LCD Televisions
- Stadium and Advertising Displays

## DESCRIPTION

The LT<sup>®</sup>3595 is a high performance LED Driver designed to drive sixteen independent channels of up to 10 LEDs at currents up to 50mA. Series connection of the LEDs provides identical LED currents resulting in uniform brightness. Power switches, Schottky diodes, and compensation components are all internal, providing a small converter footprint and lower component cost. The high 2MHz switching frequency permits the use of tiny, low profile inductors and capacitors. A fixed frequency, current mode architecture results in stable operation over a wide range of supply and output voltage.

A single external resistor sets the LED current for all sixteen channels, and dimming is then controlled for each channel by pulse width modulating the individual PWM pins. Relative current matching among the sixteen drivers is 8% and the PWM dimming range is 5000:1. The part is available in a 5mm × 9mm × 0.75mm 56-pin QFN package.

LT, LT, LTC and LTM are registered trademarks of Linear Technology Corporation. True Color PWM is a trademark of Linear Technology Corporation. All other trademarks are the property of their respective owners.

## TYPICAL APPLICATION

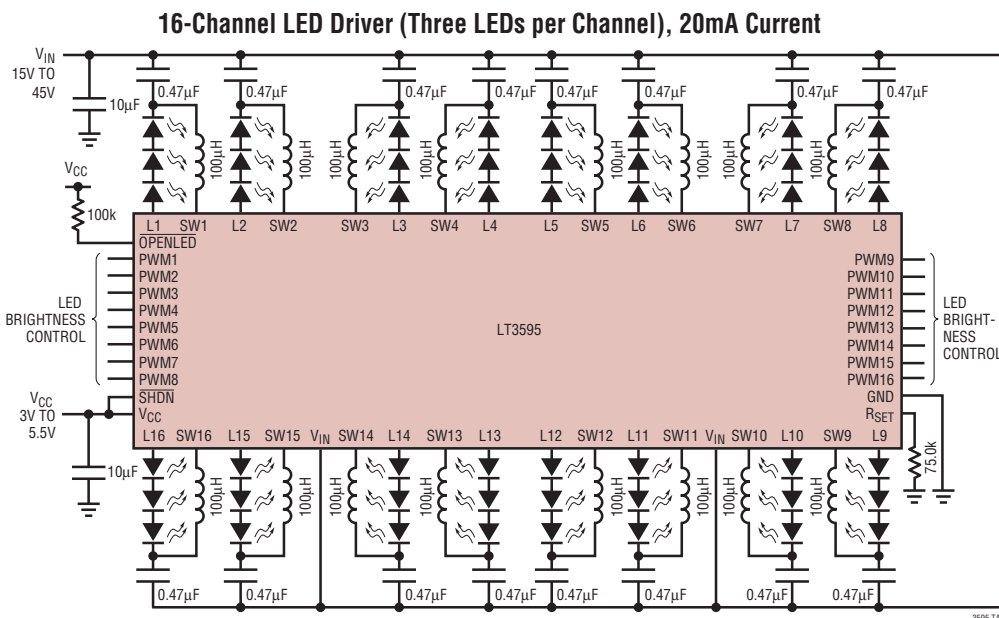

**5000:1 PWM  
Dimming at 100Hz**

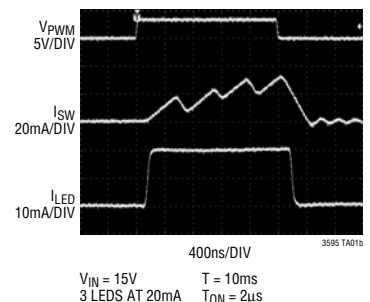

## ABSOLUTE MAXIMUM RATINGS

(Note 1)

Input Voltage ( $V_{IN}$ ) .....	45V
L1-16 Voltage .....	45V
Supply Voltage ( $V_{CC}$ ) .....	6V
$R_{SET}$ , $\overline{OPENLED}$ , PWM1-16, $\overline{SHDN}$ Voltage .....	6V
Operating Junction Temperature Range (Note 2) .....	-40°C to 85°C
Maximum Junction Temperature .....	125°C
Storage Temperature Range.....	-65°C to 125°C

## PIN CONFIGURATION

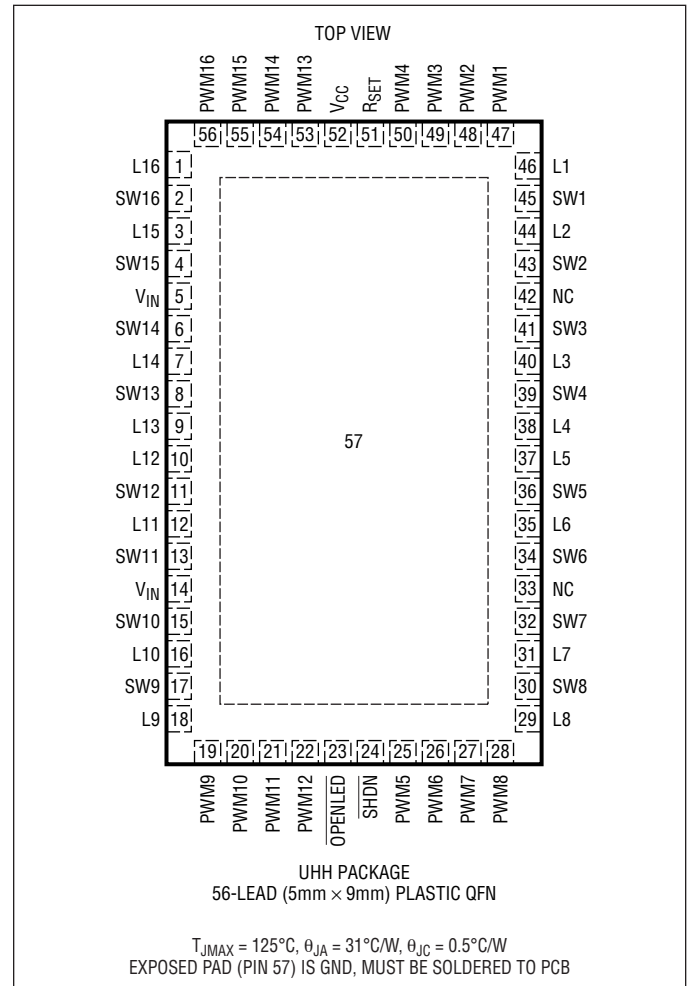

## ORDER INFORMATION

LEAD FREE FINISH	TAPE AND REEL	PART MARKING	PACKAGE DESCRIPTION	TEMPERATURE RANGE
LT3595EUHH#PBF	LT3595EUHH#TRPBF	3595	56-Lead (5mm × 9mm) Plastic QFN	-40°C to 85°C

Consult LTC Marketing for parts specified with wider operating temperature ranges.

Consult LTC Marketing for information on non-standard lead based finish parts.

For more information on lead free part marking, go to: <http://www.linear.com/leadfree/>

For more information on tape and reel specifications, go to: <http://www.linear.com/tapeandreeel/>

## ELECTRICAL CHARACTERISTICS

The ● denotes the specifications which apply over the full operating temperature range, otherwise specifications are at  $T_A = 25^\circ\text{C}$ ,  $V_{IN} = 45\text{V}$ ,  $V_{CC} = 3.3\text{V}$ ,  $\text{PWM} = \text{SHDN} = \text{OPENLED} = 3.3\text{V}$ ,  $R_{SET} = 75\text{k}\Omega$ ,  $\text{GND} = 0\text{V}$ , unless otherwise noted.

PARAMETER	CONDITIONS	MIN	TYP	MAX	UNITS
$V_{IN}$ Operating Voltage		4.5			V
$V_{CC}$ Operating Voltage		3		5.5	V
$V_{CC}$ Input Under Voltage Lockout			2.6	2.9	V
$I_{VIN}$ Quiescent Current ON, No Switching	$V_{IN} = 45\text{V}$		0.25		mA
$I_{VIN}$ Quiescent Current in Shutdown	$V_{IN} = 45\text{V}$ , $\text{SHDN} = 0\text{V}$		15	40	$\mu\text{A}$
$I_{VCC}$ Quiescent Current ON, No Switching	$V_{CC} = 3.3\text{V}$		17		mA
$I_{VCC}$ Quiescent Current in Shutdown	$V_{CC} = 3.3\text{V}$ , $\text{SHDN} = 0\text{V}$		3	10	$\mu\text{A}$
$I_{L1-16}$ Output Current Accuracy	$R_{SET} = 75.0\text{k}\Omega$	18.4	20	21.6	mA
Switching Frequency		1.6	2	2.4	MHz
Maximum Duty Cycle		● 78	83		%
Switch Current Limit		● 90	120	150	mA
Switch $V_{CESAT}$	$I_{SW1-16} = 50\text{mA}$		450		mV
Switch Leakage Current	$V_{SW1-16} = 45\text{V}$		0.1	6	$\mu\text{A}$
Schottky Forward Drop	$I_{SCHOTTKY} = 50\text{mA}$		0.8		V
Schottky Leakage Current	$V_{IN} = 45\text{V}$ , $V_{SW1-16} = 0.7\text{V}$ , $\text{SHDN} = 0\text{V}$		0.1	4	$\mu\text{A}$
$\text{SHDN}$ , PWM1-16 Input Low Voltage				0.4	V
$\text{SHDN}$ , PWM1-16 Input High Voltage		1.6			V
$\text{SHDN}$ Pin Bias Current	$\text{SHDN} = 3.3\text{V}$		35		$\mu\text{A}$
PWM1-16 Pin Bias Current	PWM1-16 = 3.3V		0.1	1	$\mu\text{A}$
$\text{OPENLED}$ Pin Voltage	$V_{CC} = 3.3\text{V}$ , $I_{\text{OPENLED}} = 200\mu\text{A}$		0.12		V
$\text{OPENLED}$ Pin Input Leakage Current	$\text{OPENLED} = 3.3\text{V}$		0.1	1	$\mu\text{A}$

**Note 1:** Stresses beyond those listed under Absolute Maximum Ratings may cause permanent damage to the device. Exposure to any Absolute Maximum Rating condition for extended periods may affect device reliability and lifetime.

**Note 2:** The LT3595 is guaranteed to meet performance specifications from  $0^\circ\text{C}$  to  $85^\circ\text{C}$  junction temperature. Specifications over the  $-40^\circ\text{C}$  to  $85^\circ\text{C}$  operating junction temperature range are assured by design, characterization and correlation with statistical process controls.

TYPICAL PERFORMANCE CHARACTERISTICS

Switching Waveforms

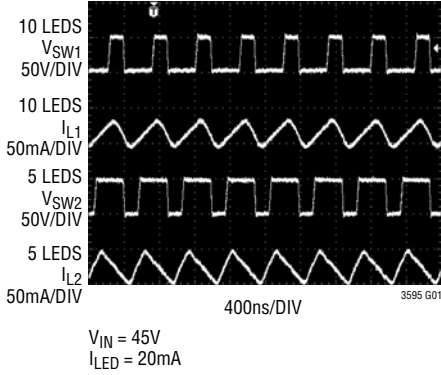

PWM Dimming Waveforms (1000:1)

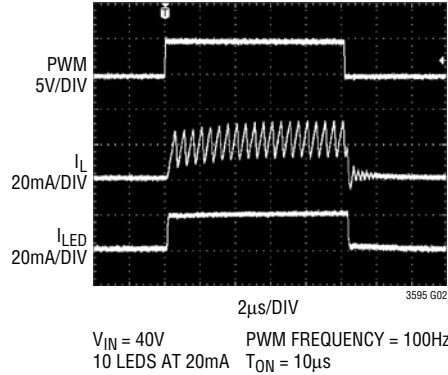

PWM Dimming Waveforms (10:1)

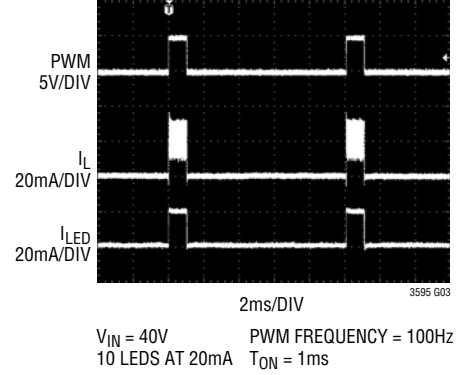

LED Current vs PWM Duty Cycle Wide Dimming Range (5000:1)

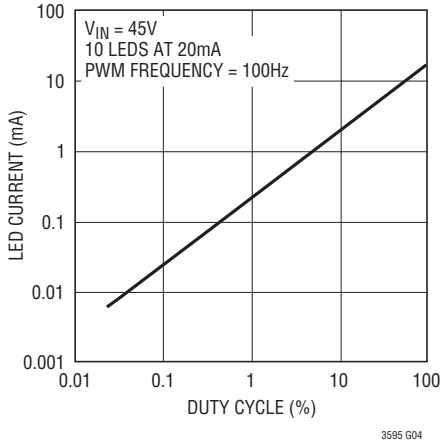

LED Current vs R<sub>SET</sub> Resistance

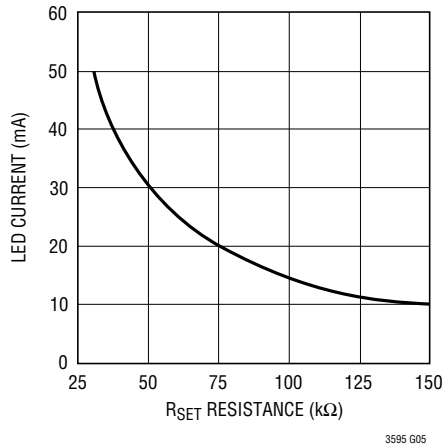

V<sub>IN</sub> Quiescent Current

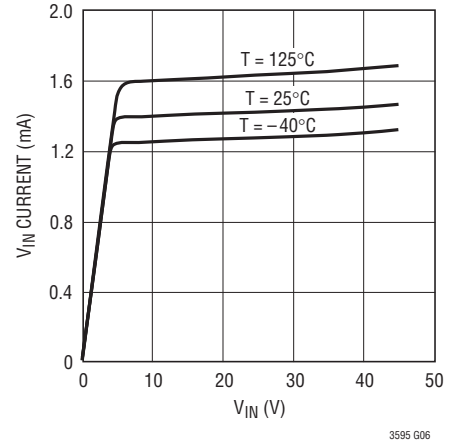

V<sub>CC</sub> Quiescent Current

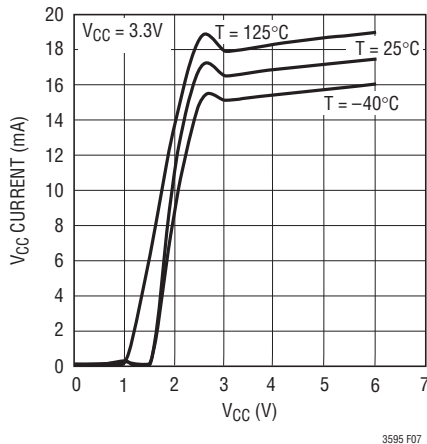

SHDN Pin Bias Current

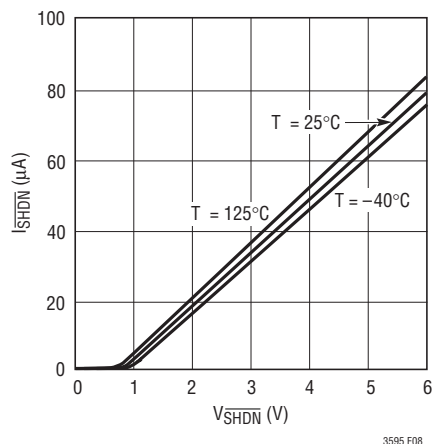

# TYPICAL PERFORMANCE CHARACTERISTICS

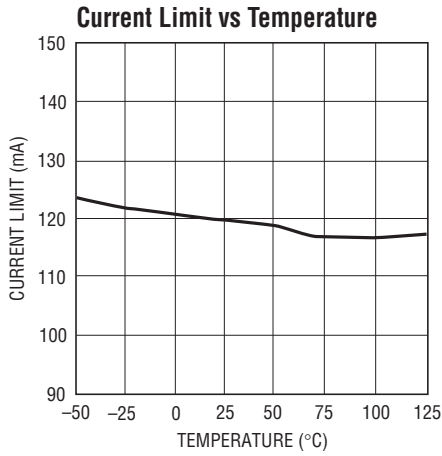

3595 G09

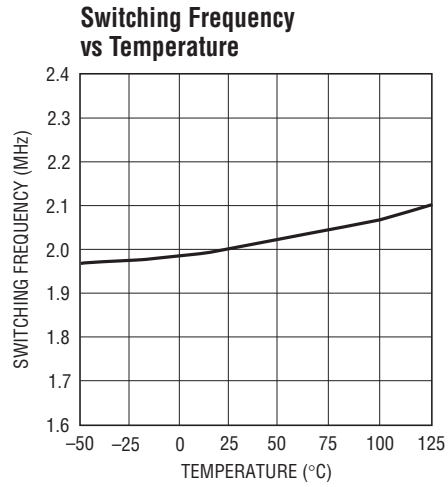

3595 G10

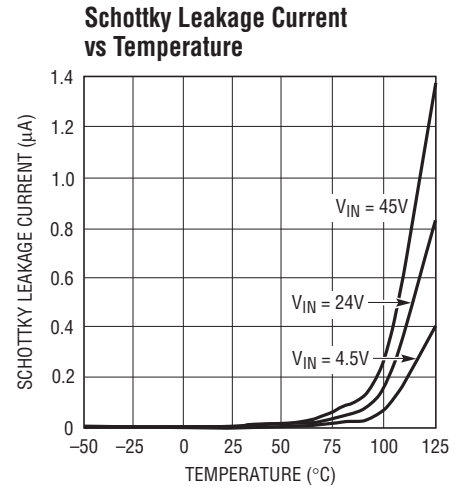

3595 G11

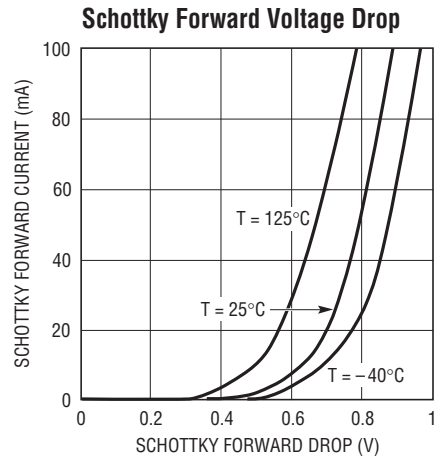
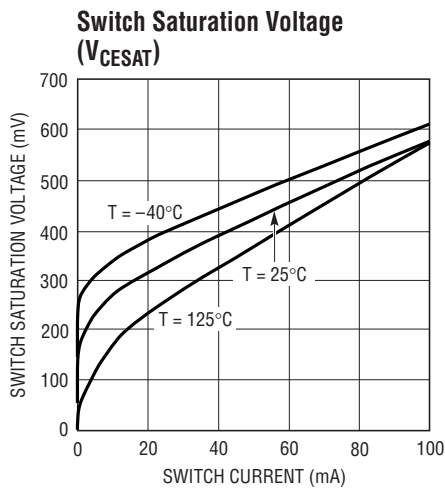

3595 G13

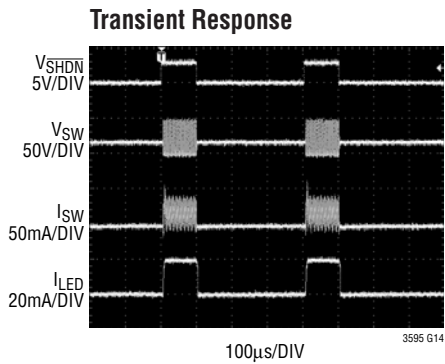

3595 G14

V<sub>IN</sub> = 45V  
10 LEDs AT 20mA

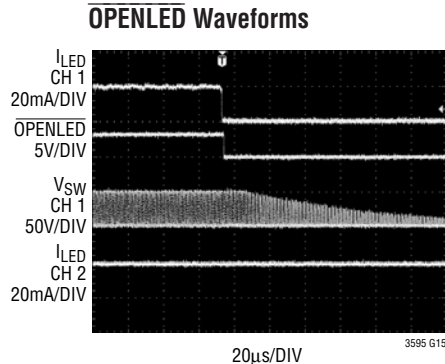

3595 G15

V<sub>IN</sub> = 45V  
10 LEDs AT 20mA

## PIN FUNCTIONS

**L1-16 (Pins 1, 3, 7, 9, 10, 12, 16, 18, 29, 31, 35, 37, 38, 40, 44, 46):** LED Pins. Connection point for the anode of the highest LED in each string.

**SW1-16 (Pins 2, 4, 6, 8, 11, 13, 15, 17, 30, 32, 34, 36, 39, 41, 43, 45):** Switch Pins. Minimize trace area at these pins to minimize EMI. Connect the inductors to these pins.

**V<sub>IN</sub> (Pins 5, 14):** 4.5V to 45V Input Supply Pin. Must be locally bypassed. Both V<sub>IN</sub> pins must be tied together.

**PWM1-16 (Pins 19-22, 25-28, 47-50, 53-56):** Input Pin for LED Dimming Function. The rising edge of each channel must be synchronized.

**OPENLED (Pin 23):** Open Collector Output for Reporting Faults. If any channel experiences an open LED connection, the OPENLED pin is pulled low.

**SHDN (Pin 24):** Shutdown. Tie to 1.6V or greater to enable the device. Tie below 0.4V to turn off the device.

**NC (Pins 33, 42):** No Connect. Connect these pins to ground.

**R<sub>SET</sub> (Pin 51):** External Resistor to Set the Master LED Current. The LED current is equal to:

$$I_{LED} = \frac{1.21V}{R_{SET}} \cdot 1240$$

where R<sub>SET</sub> is the value of the external resistor. Use a kelvin for ground metal.

**V<sub>CC</sub> (Pin 52):** 3.3V Input Supply. Must be locally bypassed.

**Exposed Pad (Pin 57):** Ground. The Exposed Pad must be soldered to PCB. Use wide metal from backtab to the grounds of the input capacitors on V<sub>CC</sub> and V<sub>IN</sub>.

**BLOCK DIAGRAM**

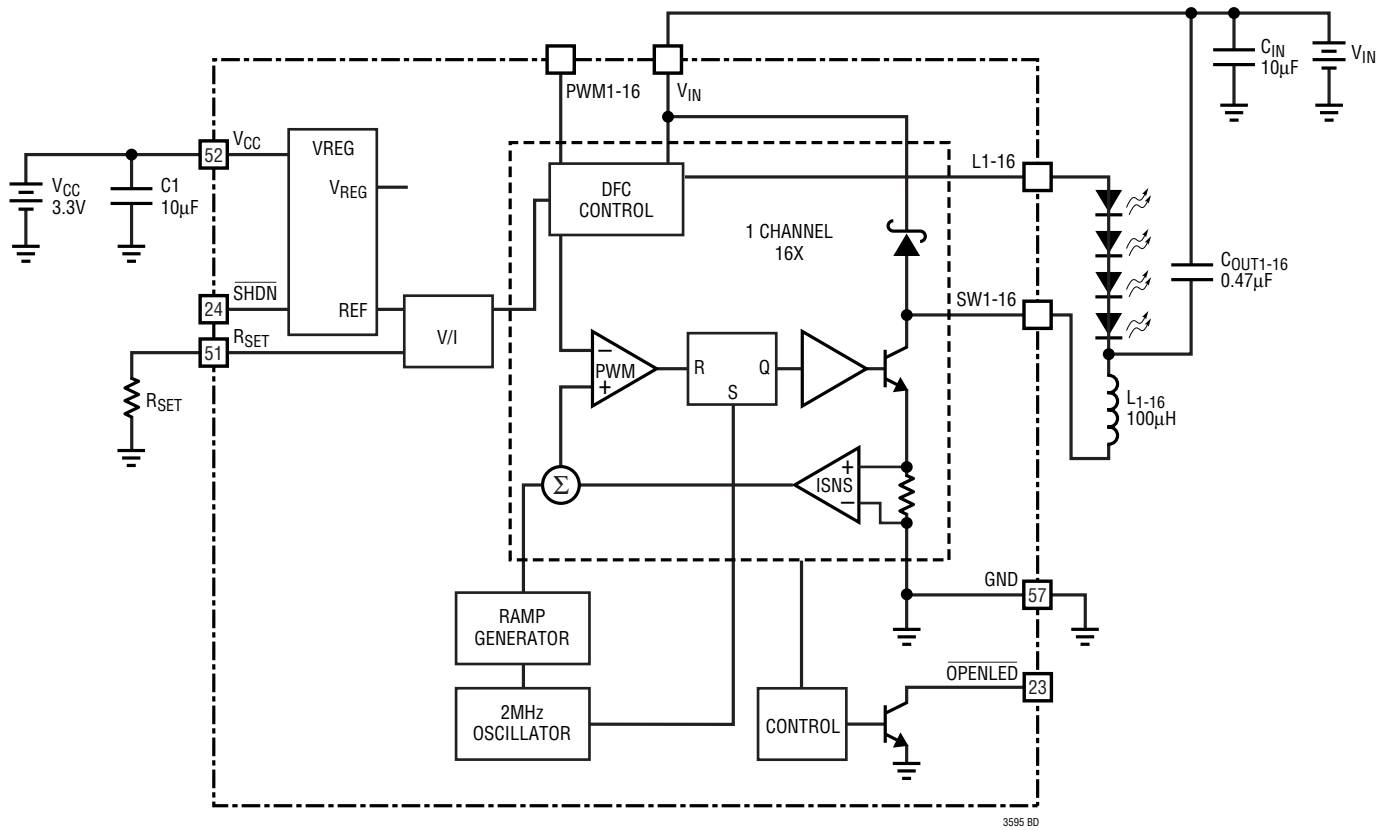

3595f B0

## OPERATION

The LT3595 uses a constant-frequency, current mode control scheme to provide excellent line and load regulation. Operation is best understood by referring to the Block Diagram. The oscillator, V-I converter and internal regulator are shared by the sixteen converters. The control circuitry, power switches, PWM comparators and dimming control (DFC) are identical for all converters.

The LT3595 enters shutdown mode when the  $\overline{\text{SHDN}}$  pin is lower than 400mV. If the  $\overline{\text{SHDN}}$  pin is above 1.6V, then the LT3595 turns on. At the start of each oscillator cycle, the power switch is turned on. Current ramps up through the output capacitor, the inductor, and the switch to ground. When the voltage across the output capacitor is larger than the LEDs' forward voltage, current flows through the LEDs.

When the switch is on, a voltage proportional to the switch current is added to a stabilizing ramp and the resulting sum is fed into the positive terminal of the PWM comparator. When this voltage exceeds the level at the negative input of the PWM comparator, the PWM logic turns off the power switch. The level at the negative input of the PWM comparator is set by the error amplifier output. This voltage is set by the LED current and the bandgap reference. In this manner, the error amplifier sets the correct peak current level in the inductor to keep the LED output current in regulation. The external  $R_{\text{SET}}$  resistor is used to program the LED current from 10mA to 50mA.

### Input Voltage Range

The minimum input voltage required to generate a specific output voltage in an LT3595 application is limited by its 4.5V input voltage or by its maximum duty cycle. The duty cycle is the fraction of time that the internal switch is on divided by the total period. It is determined by the input voltage and the voltage across the LEDs:

$$\text{DC} = \frac{V_{\text{LED}} + V_{\text{D}}}{V_{\text{VIN}} - V_{\text{CESAT}} + V_{\text{D}}}$$

where  $V_{\text{LED}}$  is the voltage drop across the LEDs,  $V_{\text{D}}$  is the Schottky forward drop, and  $V_{\text{CESAT}}$  is the saturation voltage of the internal switch. This leads to a minimum input voltage of:

$$V_{\text{IN(MIN)}} = \frac{V_{\text{LED}} + V_{\text{D}}}{\text{DC}_{\text{MAX}}} + V_{\text{CESAT}} - V_{\text{D}}$$

where  $\text{DC}_{\text{MAX}}$  is the minimum rating of maximum duty cycle.

The maximum input voltage is limited by the absolute maximum rating of 45V.

### Pulse-Skipping

At low duty cycles, the LT3595 may enter pulse-skipping mode. Low duty cycle occurs at higher input voltages and lower LED count. The LT3595 can drive currents without pulse-skipping provided the voltage across the LED string is greater than 15% of the input supply voltage. If the current decreases to the point that the LED voltage is less than 15% of the input supply, the device may begin skipping pulses. This will result in some low frequency ripple, although the LED current remains regulated on an average basis down to 10mA.



## OPERATION

### Discontinuous Current Mode

The LT3595 can drive a 10-LED string at 15mA LED current operating in continuous conduction mode using the recommended external components shown in the application circuit on page 1 of this data sheet. As current is further reduced, the regulator enters discontinuous conduction mode. The photo in Figure 1 details circuit operation driving ten LEDs at 10mA load. The inductor current reaches zero during the discharge phase and the SW pin exhibits ringing. The ringing is due to the LC tank circuit formed by the inductor in combination with the switch and diode capacitance. This ringing is not harmful; far less spectral energy is contained in the ringing than in the switch transitions.

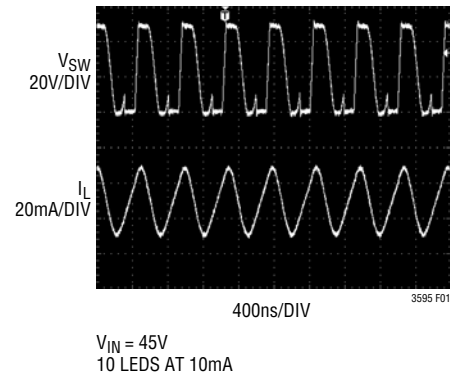

Figure 1. Switching Waveforms

## TYPICAL APPLICATIONS

### Inductor Selection

A 100μH inductor is recommended for most LT3595 applications. Although small size and high efficiency are major concerns, the inductor should have low core losses at 2MHz and low DCR (copper wire resistance). Some inductors that meet these criteria are listed in Table 1. An efficiency comparison of different inductors is shown in Figure 2.

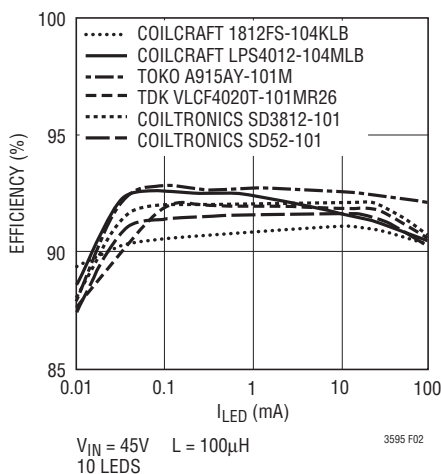

Figure 2. Efficiency Comparison of Different Inductors

Table 1. Inductor Manufacturers

VENDOR	PART SERIES	INDUCTANCE RANGE (μH) RELEVANT TO LT3595	DIMENSIONS (mm)
Coilcraft www.coilcraft.com	DO1605	100 to 680	5.4 × 4.2 × 1.8
	LPS4012	100 to 680	4 × 4 × 1.2
	1812FS	100 to 680	5.8 × 4.9 × 3.8
	MSS5131	100 to 390	5.1 × 5.1 × 3.1
Sumida www.sumida.com	CDC4D20	100 to 680	4.8 × 4.8 × 2
Toko www.tokoam.com	D53LC	100 to 680	5.2 × 5.4 × 3
TDK www.component.tdk.com	VLCF4020T	100 to 330	4 × 4 × 2
Coiltronics www.cooperet.com	SD3812	100 to 330	4 × 4 × 1.2
	SD52	100 to 330	5.6 × 5.2 × 2
Murata www.murata.com	LQH32M	100 to 560	3.2 × 2.5 × 2
	LQH43M	100 to 680	4.5 × 3.2 × 2

### Capacitor Selection

The small size of ceramic capacitors make them ideal for LT3595 applications. Only X5R and X7R types should be used because they retain their capacitance over wider voltage and temperature ranges than other types such as Y5V or Z5U. Typically, 10μF capacitors on V<sub>IN</sub> and V<sub>CC</sub> are sufficient. The output capacitor used across the

## APPLICATIONS INFORMATION

LED string depends on the number of LEDs and can vary from 0.47 $\mu$ F to 1 $\mu$ F. Refer to Table 2 for proper output capacitor selection.

**Table 2. Recommended Output Capacitor Values ( $V_{LED} = 3.5V$ )**

# LEDs	$C_{OUT}$ ( $\mu$ F)
3-10	0.47
1-2	1

**Table 3. Recommended Ceramic Capacitor Manufacturers**

Taiyo Yuden	(408) 573-4150 www.t-yuden.com
TDK	(847) 803-6100 www.component.tdk.com
Murata	(714) 852-2001 www.murata.com
Kemet	(408)-986-0424 www.kemet.com

Table 3 shows a list of several ceramic capacitor manufacturers. Consult the manufacturers for detailed information on their entire selection of ceramic parts.

### Open LED Detection

The LT3595 detects an open LED on any channel and reports it to the  $\overline{OPENLED}$  pin. The fault also reports during startup until the output voltage and LED current are in regulation. Therefore, it can also be used as a “power ok” signal.

### Programming LED Current

The set resistor ( $R_{SET}$  in the Block Diagram) controls the LED current in all sixteen channels. LED current as a function of the  $R_{SET}$  resistance is shown in the Typical Performance Characteristics. Common values for LED current and their required resistor values are listed in Table 4. Since resistor error directly translates to LED current error, precision resistors are preferred (1% is recommended). The maximum allowed resistor value is 150k.

**Table 4. LED Current vs  $R_{SET}$  Resistance**

$R_{SET}$ ( $k\Omega$ )	$I_{LED}$ (mA)
150	10
75.0	20
49.9	30
37.4	40
30.1	50

## APPLICATIONS INFORMATION

### Dimming Control

The sixteen PWM1-16 inputs control the dimming function. Each channel is modulated by its corresponding PWM1-16 input. On a rising edge of any PWM1-16, the IC's internal support circuitry is enabled and the specific channel turns on. LED current flows in the channel until the falling edge of the PWM1-16 input. In this way, the average LED current is modulated. The minimum on time

of a channel is  $2\mu\text{s}$  and the maximum period is 10ms (at 100Hz). Therefore, the maximum dimming ratio is 5000:1. Since the maximum  $R_{\text{SET}}$  produces 10mA, the minimum modulated LED current is  $2\mu\text{A}$ .

When multiple channels are modulated, the rising edges of PWM1-16 must be synchronized. The falling edges may be asynchronous. A sample timing diagram is shown in Figure 3.

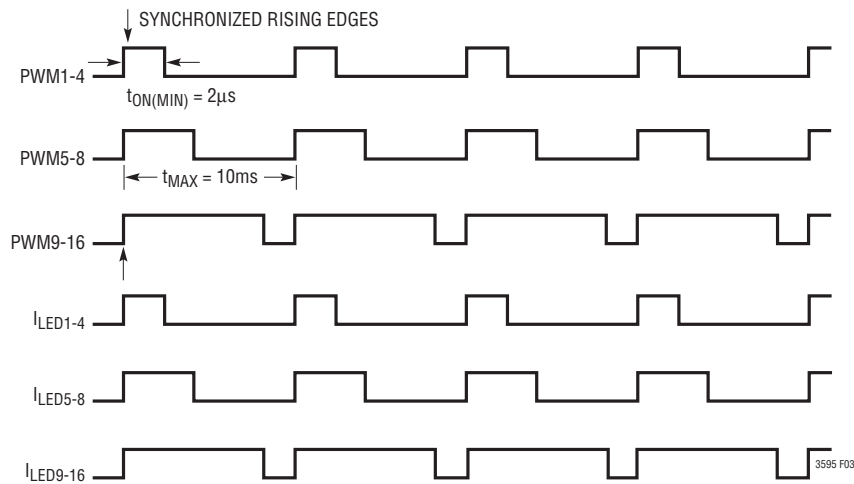

Figure 3. Timing Diagram for Multi-Channel Modulation

## APPLICATIONS INFORMATION

### Board Layout Considerations

As with all switching regulators, careful attention must be paid to the PCB board layout and component placement. To prevent electromagnetic interference (EMI) problems, proper layout of high frequency switching paths is essential. Minimize the length and area of all traces connected to

the SW1-16 and PWM1-16 pins. Keep the sense voltage pins ( $V_{IN}$  and L1-16) away from the switching nodes. Place  $C_{OUT1-16}$  and  $C_{IN}$  close to the  $V_{IN}$  pins. Always use a ground plane under the switching regulator to minimize interplane coupling. Recommended component placement is shown in Figures 4-7.

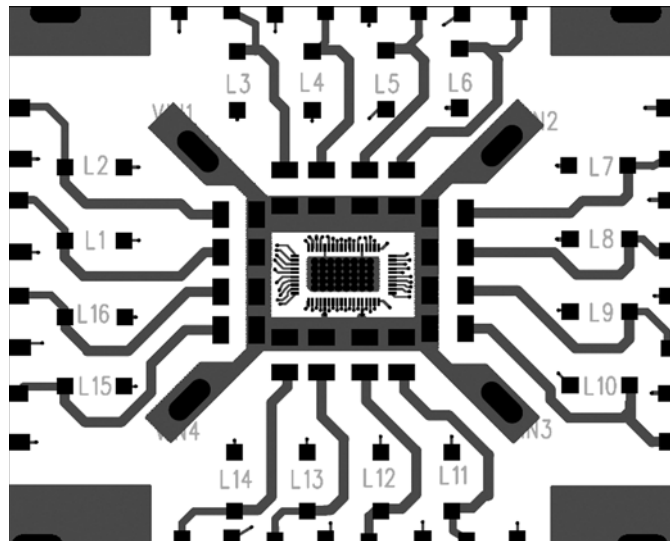

Figure 4. PCB Layer 1

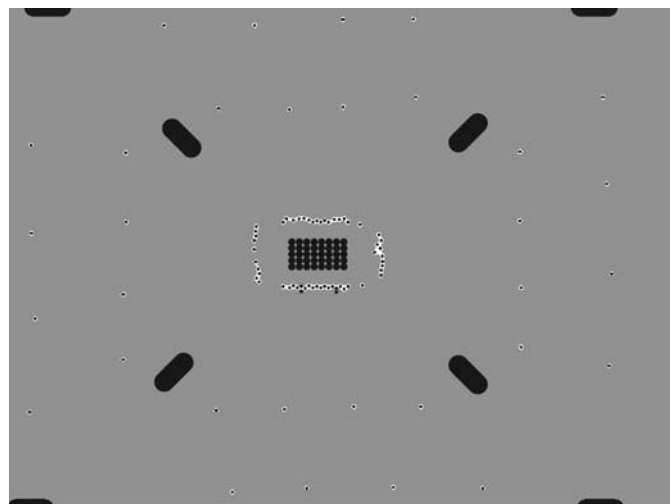

Figure 5. PCB Layer 2

APPLICATIONS INFORMATION

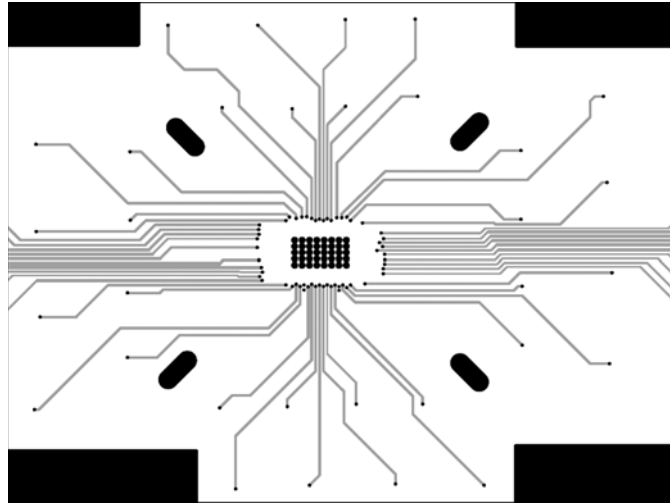

Figure 6. PCB Layer 3

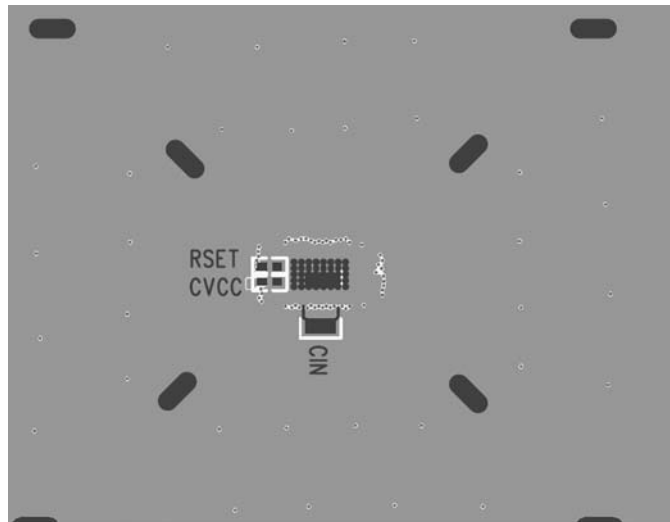
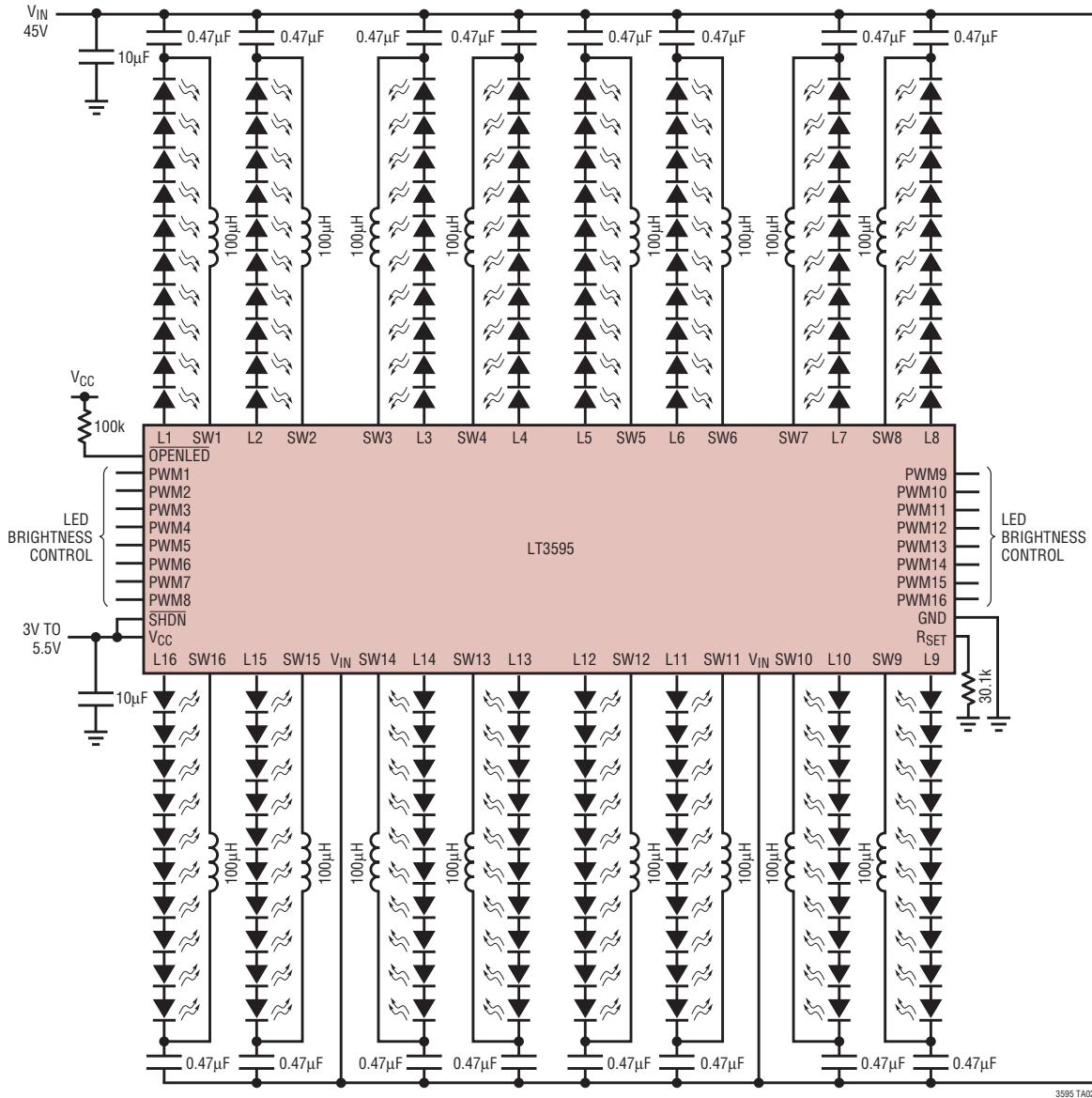

Figure 7. PCB Layer 4

TYPICAL APPLICATIONS

30W LED Driver for 160 LEDs (16 Strings, 10 LEDs per String) at 50mA



Conversion Efficiency

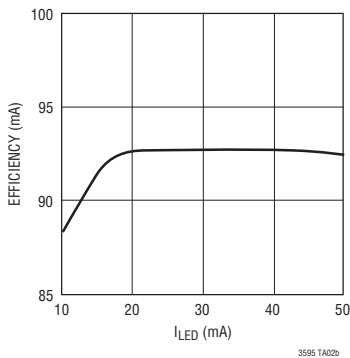

5000:1 PWM Dimming at 100Hz

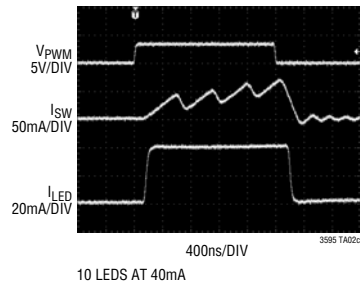



## TYPICAL APPLICATIONS

### 16-Channel LED Driver (Three LEDs per Channel), 20mA Current

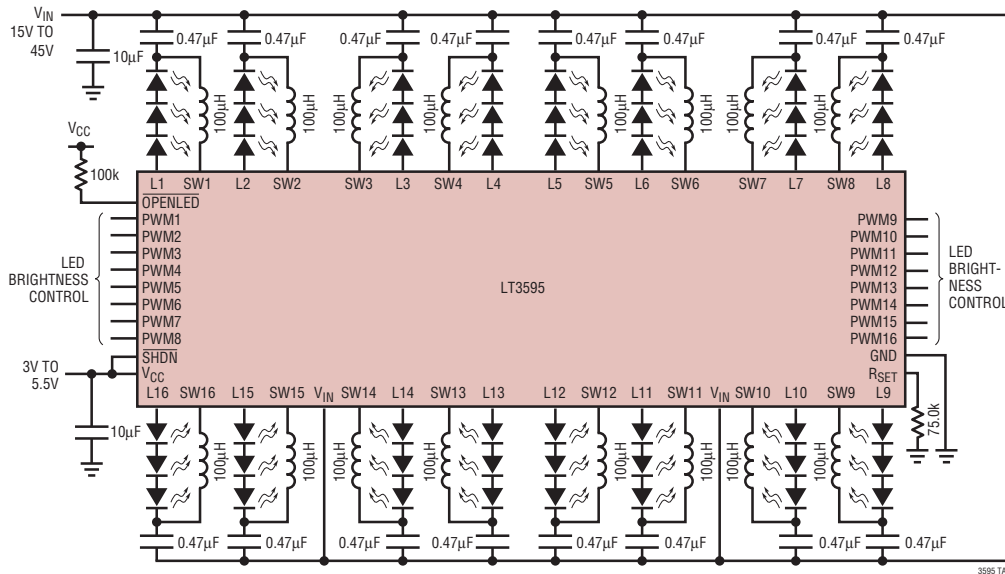

### 5000:1 PWM Dimming at 100Hz

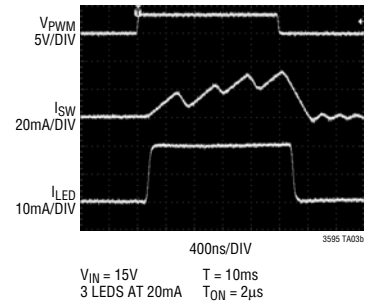

## RELATED PARTS

PART NUMBER	DESCRIPTION	COMMENTS
LT3463/ LT3463A	Dual Output, Boost/Inverter, 250mA I <sub>SW</sub> , Constant Off-Time, High Efficiency Step-Up DC/DC Converter with Integrated Schottky Diodes	V <sub>IN</sub> : 2.3V to 15V, V <sub>OUT(MAX)</sub> = ±40V, I <sub>Q</sub> = 40µA, I <sub>SD</sub> < 1µA, 3mm × 3mm DFN-10 Package
LT3465/ LT3465A	Constant-Current, 1.2MHz/2.7MHz, High Efficiency White LED Boost Regulator with Integrated Schottky Diode	V <sub>IN</sub> : 2.7V to 16V, V <sub>OUT(MAX)</sub> = 34V, I <sub>Q</sub> = 1.9mA, I <sub>SD</sub> < 1µA, ThinSOT™ Package
LT3466/ LT3466-1	Dual Constant-Current, 2MHz, High Efficiency White LED Boost Regulator with Integrated Schottky Diode	V <sub>IN</sub> : 2.7V to 24V, V <sub>OUT(MAX)</sub> = 40V, I <sub>Q</sub> = 5mA, I <sub>SD</sub> < 16µA, 3mm × 3mm DFN-10 Package
LT3474	36V, 1A (I <sub>LED</sub> ), 2MHz, Step-Down LED Driver	V <sub>IN</sub> : 4V to 36V, V <sub>OUT(MAX)</sub> = 13.5V, 400:1 True Color PWM™, I <sub>SD</sub> < 1µA, TSSOP-16E Package
LT3475	Dual 1.5A (I <sub>LED</sub> ), 36V, 2MHz, Step-Down LED Driver	V <sub>IN</sub> : 4V to 36V, V <sub>OUT(MAX)</sub> = 13.5V, 3000:1 True Color PWM, I <sub>SD</sub> < 1µA, TSSOP-20E Package
LT3476	Quad Output 1.5A, 2MHz High Current LED Driver with 1000:1 Dimming	V <sub>IN</sub> : 2.8V to 16V, V <sub>OUT(MAX)</sub> = 36V, 1000:1 True Color PWM, I <sub>SD</sub> < 10µA, 5mm × 7mm QFN-10 Package
LT3486	Dual 1.3A, 2MHz High Current LED Driver	V <sub>IN</sub> : 2.5V to 24V, V <sub>OUT(MAX)</sub> = 36V, 1000:1 True Color PWM, I <sub>SD</sub> < 1µA, 5mm × 3mm DFN and TSSOP-16E Packages
LT3491	Constant-Current, 2.3MHz, High Efficiency White LED Boost Regulator with Integrated Schottky Diode	V <sub>IN</sub> : 2.5V to 12V, V <sub>OUT(MAX)</sub> = 27V, I <sub>Q</sub> = 2.6mA, I <sub>SD</sub> < 8µA, 2mm × 2mm DFN-6 and SC70 Packages
LT3497	Dual 2.3MHz, Full Function LED Driver with Integrated Schottky Diodes and 250:1 True Color PWM Dimming	V <sub>IN</sub> : 2.5V to 10V, V <sub>OUT(MAX)</sub> = 32V, I <sub>Q</sub> = 6µA, I <sub>SD</sub> < 12µA, 3mm × 2mm DFN-10 Package
LT3498	2.3MHz, 20mA LED Driver and OLED Driver with Integrated Schottky Diodes	V <sub>IN</sub> : 2.5V to 12V, V <sub>OUT(MAX)</sub> = 32V, I <sub>Q</sub> = 1.65mA, I <sub>SD</sub> < 9µA, 3mm × 2mm DFN-12 Package
LT3517/LT3518	2.3A/1.3A 45V, 2.5MHz Full Featured LED Driver with True Color PWM Dimming	V <sub>IN</sub> : 3V to 30V/40V, V <sub>OUT(MAX)</sub> = 42V, 3000:1 True Color PWM, I <sub>SD</sub> < 5µA, 4mm × 4mm QFN-16 Package
LT3590	48V Buck Mode LED Driver	V <sub>IN</sub> : 4.5V to 55V, V <sub>OUT(MAX)</sub> = 5V, I <sub>Q</sub> = 700µA, I <sub>SD</sub> < 15µA, 2mm × 2mm DFN-16 and SC70 Packages
LT3591	Constant-Current, 1MHz, High Efficiency White LED Boost Regulator with Integrated Schottky Diode and 80:1 True Color PWM Dimming	V <sub>IN</sub> : 2.5V to 12V, V <sub>OUT(MAX)</sub> = 40V, I <sub>Q</sub> = 4mA, I <sub>SD</sub> < 9µA, 3mm × 2mm DFN-8 Package

True Color PWM and ThinSOT are trademarks of Linear Technology Corporation.