

# Ultralow Power RS485 Transceiver with Shutdown

## FEATURES

- **Low Power:  $I_{CC} = 120\mu\text{A}$  Max with Driver Disabled**
- **Drivers/Receivers Have  $\pm 10\text{kV}$  ESD Protection**
- **$1\mu\text{A}$  Quiescent Current in Shutdown Mode**
- **High Speed: Up to 2.5Mbps/s Data Rate**
- $I_{CC} = 500\mu\text{A}$  Max with Driver Enabled, No Load
- Single 5V Supply
- $-7\text{V}$  to  $12\text{V}$  Common Mode Range Permits  $\pm 7\text{V}$  Ground Difference Between Devices on the Data Line
- Thermal Shutdown Protection
- Power Up/Down Glitch-Free Driver Outputs Permit Live Insertion or Removal of Transceiver
- Driver Maintains High Impedance in Three-State or with the Power Off
- Up to 32 Transceivers on the Bus
- 30ns Typical Driver Propagation Delays with 5ns Skew
- Pin Compatible with the LTC485

## APPLICATIONS

- Battery-Powered RS485/RS422 Applications
- Low Power RS485/RS422 Transceiver
- Level Translator

## DESCRIPTION

The LTC<sup>®</sup>1481 is an ultralow power differential line transceiver designed for data transmission standard RS485 applications. It will also meet the requirements of RS422. The CMOS design offers significant power savings over its bipolar counterparts without sacrificing ruggedness against overload or ESD damage. Typical quiescent current is only  $80\mu\text{A}$  while operating and less than  $1\mu\text{A}$  in shutdown.

The driver and receiver feature three-state outputs, with the driver outputs maintaining high impedance over the entire common mode range. Excessive power dissipation caused by bus contention or faults is prevented by a thermal shutdown circuit which forces the driver outputs into a high impedance state. The receiver has a fail-safe feature which guarantees a high output state when the inputs are left open.

The LTC1481 is fully specified over the commercial and extended industrial temperature range and is available in 8-pin PDIP and SO packages.

LT, LTC and LT are registered trademarks of Linear Technology Corporation.

## TYPICAL APPLICATION

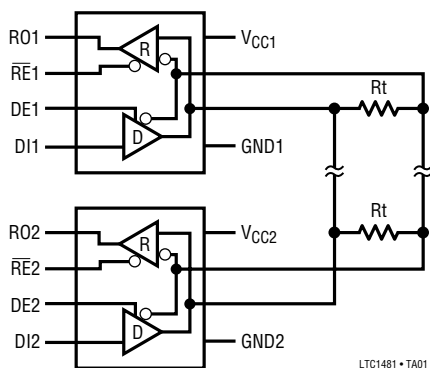

Supply Current vs Temperature

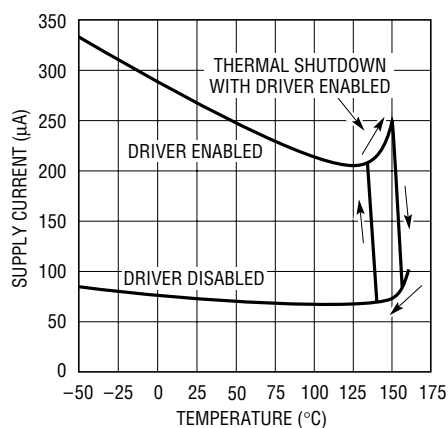

1481 TA02

**ABSOLUTE MAXIMUM RATINGS**

(Note 1)

Supply Voltage ( $V_{CC}$ ) .....	12V
Control Input Voltage .....	-0.5V to $V_{CC} + 0.5V$
Driver Input Voltage .....	-0.5V to $V_{CC} + 0.5V$
Driver Output Voltage .....	$\pm 14V$
Receiver Input Voltage .....	$\pm 14V$
Receiver Output Voltage .....	-0.5V to $V_{CC} + 0.5V$
Operating Temperature Range	
LTC1481C .....	$0^{\circ}C \leq T_A \leq 70^{\circ}C$
LTC1481I .....	$-40^{\circ}C \leq T_A \leq 85^{\circ}C$
Storage Temperature Range .....	$-65^{\circ}C$ to $150^{\circ}C$
Lead Temperature (Soldering, 10 sec) .....	$300^{\circ}C$

**PACKAGE/ORDER INFORMATION**

<p>N8 PACKAGE 8-LEAD PDIP</p> <p>S8 PACKAGE 8-LEAD PLASTIC SO</p> <p><math>T_{JMAX} = 125^{\circ}C, \theta_{JA} = 130^{\circ}C/W</math> (N8) <math>T_{JMAX} = 125^{\circ}C, \theta_{JA} = 150^{\circ}C/W</math> (S8)</p>	ORDER PART NUMBER
	LTC1481CN8 LTC1481IN8 LTC1481CS8 LTC1481IS8
	S8 PART MARKING
	1481 1481I

Consult LTC Marketing for parts specified with wider operating temperature ranges.

**ELECTRICAL CHARACTERISTICS**

The ● denotes the specifications which apply over the full operating temperature range, otherwise specifications are at  $T_A = 25^{\circ}C$ .  $V_{CC} = 5V$  (Notes 2, 3) unless otherwise noted.

SYMBOL	PARAMETER	CONDITIONS	MIN	TYP	MAX	UNITS
$V_{OD1}$	Differential Driver Output Voltage (Unloaded)	$I_O = 0$	●		5	V
$V_{OD2}$	Differential Driver Output Voltage (with Load)	$R = 50\Omega$ (RS422) $R = 27\Omega$ (RS485), Figure 1	● ●	2.0 1.5	5	V V
$\Delta V_{OD}$	Change in Magnitude of Driver Differential Output Voltage for Complementary Output States	$R = 27\Omega$ or $R = 50\Omega$ , Figure 1	●		0.2	V
$V_{OC}$	Driver Common Mode Output Voltage	$R = 27\Omega$ or $R = 50\Omega$ , Figure 1	●		3	V
$\Delta  V_{OC} $	Change in Magnitude of Driver Common Mode Output Voltage for Complementary Output States	$R = 27\Omega$ or $R = 50\Omega$ , Figure 1	●		0.2	V
$V_{IH}$	Input High Voltage	DE, DI, $\overline{RE}$	●	2		V
$V_{IL}$	Input Low Voltage	DE, DI, $\overline{RE}$	●		0.8	V
$I_{IN1}$	Input Current	DE, DI, $\overline{RE}$	●		$\pm 2$	$\mu A$
$I_{IN2}$	Input Current (A, B)	DE = 0, $V_{CC} = 0V$ or $5.25V$ , $V_{IN} = 12V$ DE = 0, $V_{CC} = 0V$ or $5.25V$ , $V_{IN} = -7V$	● ●		1.0 -0.8	mA mA
$V_{TH}$	Differential Input Threshold Voltage for Receiver	$-7V \leq V_{CM} \leq 12V$	●	-0.2	0.2	V
$\Delta V_{TH}$	Receiver Input Hysteresis	$V_{CM} = 0V$	●	45		mV
$V_{OH}$	Receiver Output High Voltage	$I_O = -4mA$ , $V_{ID} = 200mV$	●	3.5		V
$V_{OL}$	Receiver Output Low Voltage	$I_O = 4mA$ , $V_{ID} = -200mV$	●		0.4	V
$I_{OZR}$	Three-State (High Impedance) Output Current at Receiver	$V_{CC} = \text{Max}$ , $0.4V \leq V_O \leq 2.4V$	●		$\pm 1$	$\mu A$
$R_{IN}$	Receiver Input Resistance	$-7V \leq V_{CM} \leq 12V$	●	12		k $\Omega$
$I_{CC}$	Supply Current	No Load, Output Enabled No Load, Output Disabled	● ●	300 80	500 120	$\mu A$ $\mu A$
$I_{SHDN}$	Supply Current in Shutdown Mode	DE = 0, $\overline{RE} = V_{CC}$		1	10	$\mu A$
$I_{OSD1}$	Driver Short-Circuit Current, $V_{OUT} = \text{HIGH}$	$-7V \leq V_O \leq 12V$	●	35	250	mA
$I_{OSD2}$	Driver Short-Circuit Current, $V_{OUT} = \text{LOW}$	$-7V \leq V_O \leq 12V$	●	35	250	mA
$I_{OSR}$	Receiver Short-Circuit Current	$0V \leq V_O \leq V_{CC}$	●	7	85	mA

## SWITCHING CHARACTERISTICS

The ● denotes the specifications which apply over the full operating temperature range, otherwise specifications are at  $T_A = 25^\circ\text{C}$ .  $V_{CC} = 5\text{V}$  (Notes 2, 3) unless otherwise noted.

SYMBOL	PARAMETER	CONDITIONS	MIN	TYP	MAX	UNITS	
$t_{PLH}$	Driver Input to Output	$R_{DIFF} = 54\Omega$ , $C_{L1} = C_{L2} = 100\text{pF}$ , (Figures 3, 5)	●	10	30	60	ns
$t_{PHL}$	Driver Input to Output		●	10	30	60	ns
$t_{SKEW}$	Driver Output to Output		●		5	10	ns
$t_r, t_f$	Driver Rise or Fall Time		●	3	15	40	ns
$t_{ZH}$	Driver Enable to Output High	$C_L = 100\text{pF}$ (Figures 4, 6), S2 Closed	●		40	70	ns
$t_{ZL}$	Driver Enable to Output Low	$C_L = 100\text{pF}$ (Figures 4, 6), S1 Closed	●		40	70	ns
$t_{LZ}$	Driver Disable Time from Low	$C_L = 15\text{pF}$ (Figures 4, 6), S1 Closed	●		40	70	ns
$t_{HZ}$	Driver Disable Time from High	$C_L = 15\text{pF}$ (Figures 4, 6), S2 Closed	●		40	70	ns
$t_{PLH}$	Receiver Input to Output	$R_{DIFF} = 54\Omega$ , $C_{L1} = C_{L2} = 100\text{pF}$ , (Figures 3, 7)	●	30	140	200	ns
$t_{PHL}$	Receiver Input to Output		●	30	140	200	ns
$t_{SKD}$	$ t_{PLH} - t_{PHL} $ Differential Receiver Skew		●		13		ns
$t_{ZL}$	Receiver Enable to Output Low	$C_{RL} = 15\text{pF}$ (Figures 2, 8), S1 Closed	●		20	50	ns
$t_{ZH}$	Receiver Enable to Output High	$C_{RL} = 15\text{pF}$ (Figures 2, 8), S2 Closed	●		20	50	ns
$t_{LZ}$	Receiver Disable from Low	$C_{RL} = 15\text{pF}$ (Figures 2, 8), S1 Closed	●		20	50	ns
$t_{HZ}$	Receiver Disable from High	$C_{RL} = 15\text{pF}$ (Figures 2, 8), S2 Closed	●		20	50	ns
$f_{MAX}$	Maximum Data Rate		●	2.5		Mbits/s	
$t_{SHDN}$	Time to Shutdown	$DE = 0$ , $RE = \overline{1}$	●	50	200	600	ns
$t_{ZH(SHDN)}$	Driver Enable from Shutdown to Output High	$C_L = 100\text{pF}$ (Figures 4, 6), S2 Closed	●		40	100	ns
$t_{ZL(SHDN)}$	Driver Enable from Shutdown to Output Low	$C_L = 100\text{pF}$ (Figures 4, 6), S1 Closed	●		40	100	ns
$t_{ZH(SHDN)}$	Receiver Enable from Shutdown to Output High	$C_L = 15\text{pF}$ (Figures 2, 8), S2 Closed	●			3500	ns
$t_{ZL(SHDN)}$	Receiver Enable from Shutdown to Output Low	$C_L = 15\text{pF}$ (Figures 2, 8), S1 Closed	●			3500	ns

**Note 1:** Absolute Maximum Ratings are those values beyond which the life of the device may be impaired.

**Note 2:** All currents into device pins are positive; all currents out of device pins are negative. All voltages are referenced to device ground unless otherwise specified.

**Note 3:** All typicals are given for  $V_{CC} = 5\text{V}$  and  $T_A = 25^\circ\text{C}$ .

## TYPICAL PERFORMANCE CHARACTERISTICS

Driver Differential Output Voltage vs Output Current

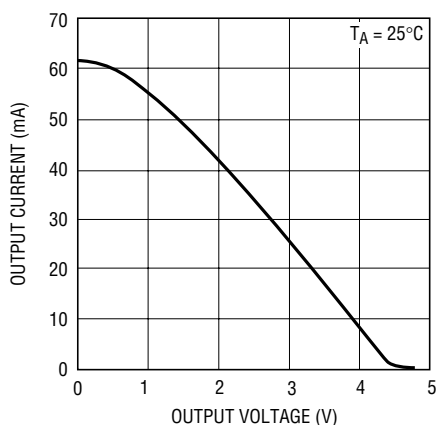

1481 G01

Driver Differential Output Voltage vs Temperature

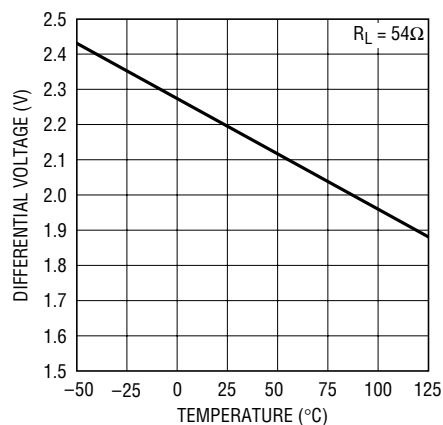

1481 G02

Driver Output Low Voltage vs Output Current

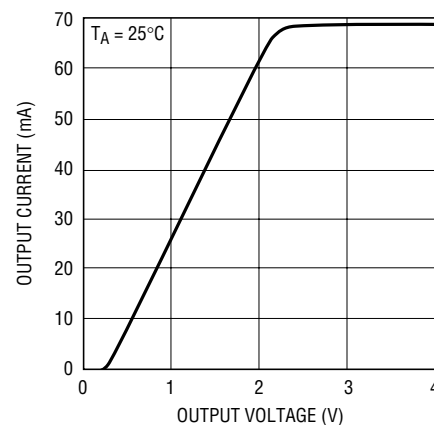
1481 G03  
1481fa

## TYPICAL PERFORMANCE CHARACTERISTICS

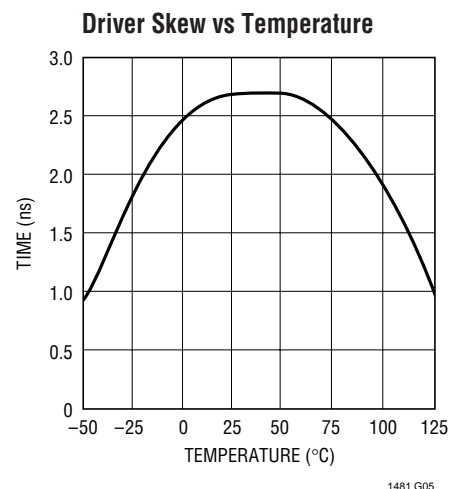
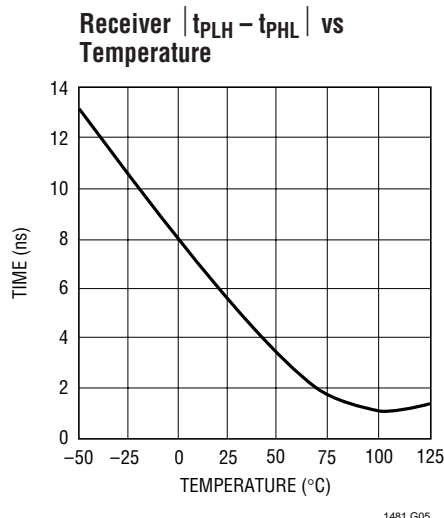
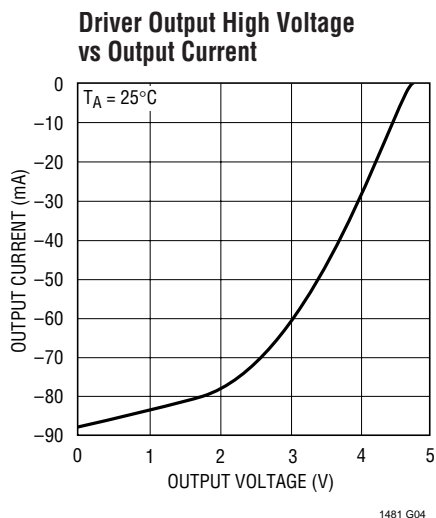

## PIN FUNCTIONS

**RO (Pin 1):** Receiver Output. If the receiver output is enabled ( $\overline{RE}$  low), then if  $A > B$  by 200mV, RO will be high. If  $A < B$  by 200mV, then RO will be low.

**$\overline{RE}$  (Pin 2):** Receiver Output Enable. A low enables the receiver output, RO. A high input forces the receiver output into a high impedance state.

**DE (Pin 3):** Driver Outputs Enable. A high on DE enables the driver output. A, B and the chip will function as a line driver. A low input will force the driver outputs into a high impedance state and the chip will function as a line receiver. If  $\overline{RE}$  is high and DE is low, the part will enter a low power ( $1\mu\text{A}$ ) shutdown state.

**DI (Pin 4):** Driver Input. If the driver outputs are enabled (DE high) then a low on DI forces the outputs A low and B high. A high on DI with the driver outputs enabled will force A high and B low.

**GND (Pin 5):** Ground.

**A (Pin 6):** Driver Output/Receiver Input.

**B (Pin 7):** Driver Output/Receiver Input.

**$V_{CC}$  (Pin 8):** Positive Supply.  $4.75\text{V} < V_{CC} < 5.25\text{V}$ .

## FUNCTION TABLES

LTC1481 Transmitting

INPUTS			OUTPUTS	
$\overline{RE}$	DE	DI	B	A
X	1	1	0	1
X	1	0	1	0
0	0	X	Z	Z
1	0	X	Z*	Z*

\*Shutdown mode for LTC1481

LTC1481 Receiving

INPUTS			OUTPUTS
$\overline{RE}$	DE	A - B	RO
0	0	$\geq 0.2\text{V}$	1
0	0	$\leq -0.2\text{V}$	0
0	0	Inputs Open	1
1	0	X	Z*

\*Shutdown mode for LTC1481

## TEST CIRCUITS

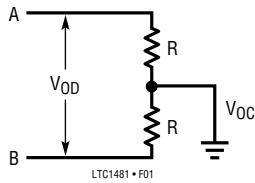

Figure 1. Driver DC Test Load

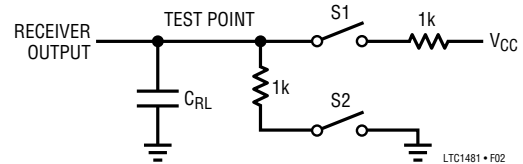

Figure 2. Receiver Timing Test Load

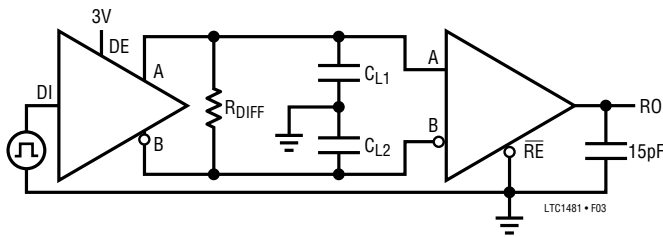

Figure 3. Driver/Receiver Timing Test Circuit

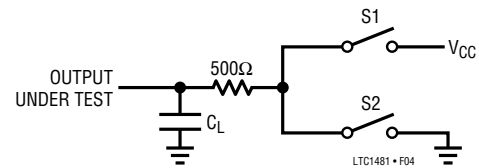

Figure 4. Driver Timing Test Load

## SWITCHING TIME WAVEFORMS

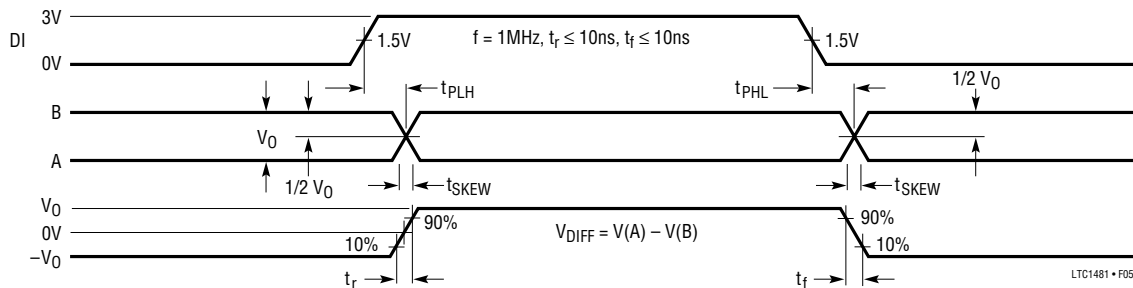

Figure 5. Driver Propagation Delays

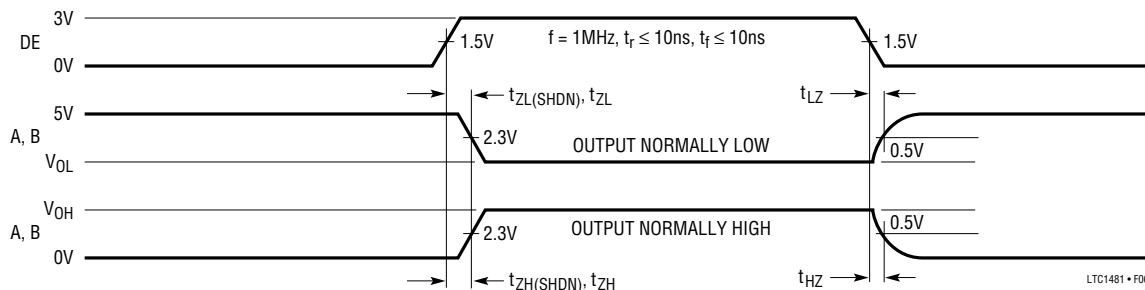

Figure 6. Driver Enable and Disable Times

## SWITCHING TIME WAVEFORMS

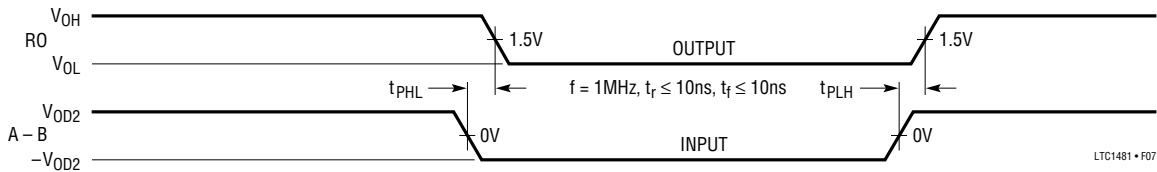

Figure 7. Receiver Propagation Delays

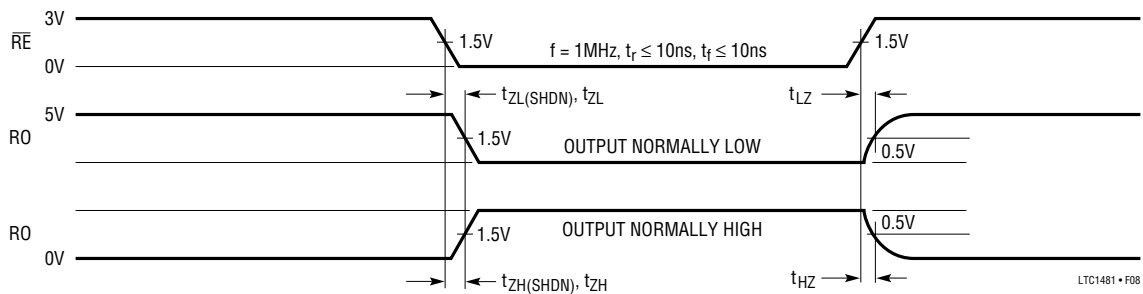

Figure 8. Receiver Enable and Disable Times

## APPLICATIONS INFORMATION

### Basic Theory of Operation

Traditionally, RS485 transceivers have been designed using bipolar technology because the common mode range of the device must extend beyond the supplies and the device must be immune to ESD damage and latch-up. Unfortunately, most bipolar devices draw a large amount of supply current, which is unacceptable for the numerous applications that require low power consumption. The LTC1481 is a CMOS RS485/RS422 transceiver which features ultralow power consumption without sacrificing ESD and latch-up immunity.

The LTC1481 uses a proprietary driver output stage, which allows a common mode range that extends beyond the power supplies while virtually eliminating latch-up and providing excellent ESD protection. Figure 9 shows the LTC1481 output stage while Figure 10 shows a conventional CMOS output stage.

When the conventional CMOS output stage of Figure 10 enters a high impedance state, both the P-channel (P1) and the N-channel (N1) are turned off. If the output is then driven above  $V_{CC}$  or below ground, the P+/N-well diode

(D1) or the N+/P-substrate diode (D2) respectively will turn on and clamp the output to the supply. Thus, the output stage is no longer in a high impedance state and is not able to meet the RS485 common mode range requirement. In addition, the large amount of current flowing through either diode will induce the well-known CMOS latch-up condition, which could destroy the device.

The LTC1481 output stage of Figure 9 eliminates these problems by adding two Schottky diodes, SD3 and SD4. The Schottky diodes are fabricated by a proprietary modification to the standard N-well CMOS process. When the output stage is operating normally, the Schottky diodes are forward biased and have a small voltage drop across them. When the output is in the high impedance state and is driven above  $V_{CC}$  or below ground, the parasitic diode D1 or D2 still turns on, but SD3 or SD4 will reverse bias and prevent current from flowing into the N-well or the substrate. Thus the high impedance state is maintained even with the output voltage beyond the supplies. With no minority carrier current flowing into the N-well or substrate, latch-up is virtually eliminated under power-up or power-down conditions.

## APPLICATIONS INFORMATION

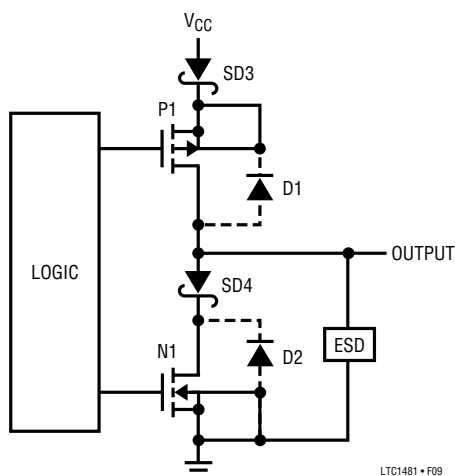

Figure 9. LTC1481 Output Stage

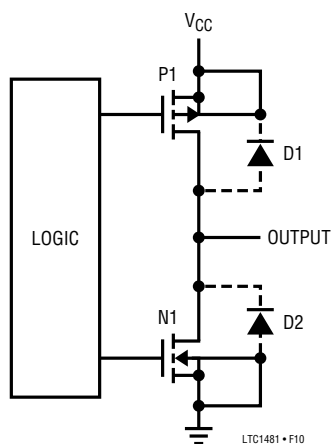

Figure 10. Conventional CMOS Output Stage

The LTC1481 output stage will maintain a high impedance state until the breakdown of the N-channel or P-channel is reached when going positive or negative respectively. The output will be clamped to either  $V_{CC}$  or ground by a Zener voltage plus a Schottky diode drop, but this voltage is well beyond the RS485 operating range. Because the ESD injected current in the N-well or substrate consists of majority carriers, latch-up is prevented by careful layout techniques. An ESD cell protects output against multiple 10kV human body model ESD strikes.

## Low Power Operation

The LTC1481 is designed to operate with a quiescent current of 120 $\mu$ A max. With the driver in three-state,  $I_{CC}$  will drop to this 120 $\mu$ A level. With the driver enabled there will be additional current drawn by the internal 12k resistor. Under normal operating conditions this additional current is overshadowed by the current drawn by the external bus impedance.

## Shutdown Mode

Both the receiver output (RO) and the driver outputs (A, B) can be placed in three-state mode by bringing  $\overline{RE}$  high and DE low respectively. In addition, the LTC1481 will enter shutdown mode when  $\overline{RE}$  is high and DE is low.

In shutdown the LTC1481 typically draws only 1 $\mu$ A of supply current. In order to guarantee that the part goes into shutdown, DE must be low and  $\overline{RE}$  must be high for at least 600ns simultaneously. If this time duration is less than 50ns the part will not enter shutdown mode. Toggling either  $\overline{RE}$  or DE will wake the LTC1481 back up within 3.5 $\mu$ s.

## Propagation Delay

Many digital encoding schemes are dependent upon the difference in the propagation delay times of the driver and receiver. Figure 11 shows the test circuit for the LTC1481 propagation delay.

The receiver delay times are:

$$|t_{PLH} - t_{PHL}| = 13\text{ns Typ, } V_{CC} = 5\text{V}$$

The drivers skew times are:

$$\text{Skew} = 5\text{ns Typ, } V_{CC} = 5\text{V}$$

$$10\text{ns Max, } V_{CC} = 5\text{V, } T_A = -40^\circ\text{C to } 85^\circ\text{C}$$

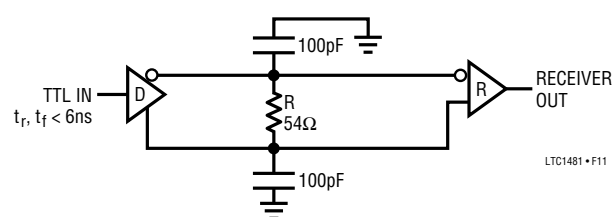
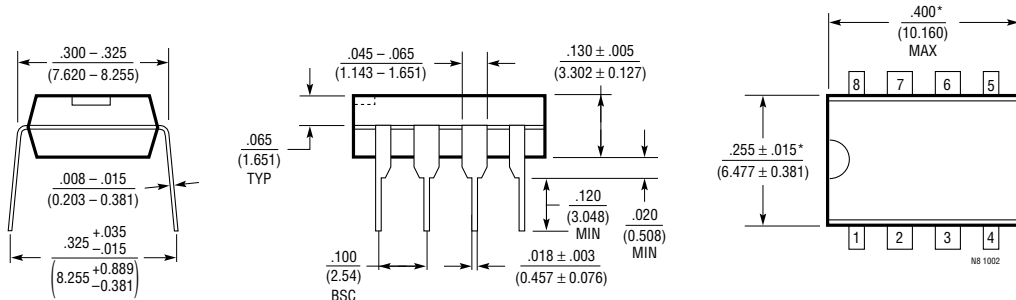

Figure 11. Receiver Propagation Delay Test Circuit

# PACKAGE DESCRIPTION

## N8 Package 8-Lead PDIP (Narrow .300 Inch) (Reference LTC DWG # 05-08-1510)



NOTE:  
1. DIMENSIONS ARE  $\frac{\text{INCHES}}{\text{MILLIMETERS}}$   
\*THESE DIMENSIONS DO NOT INCLUDE MOLD FLASH OR PROTRUSIONS.  
MOLD FLASH OR PROTRUSIONS SHALL NOT EXCEED .010 INCH (0.254mm)

## S8 Package 8-Lead Plastic Small Outline (Narrow .150 Inch) (Reference LTC DWG # 05-08-1610)

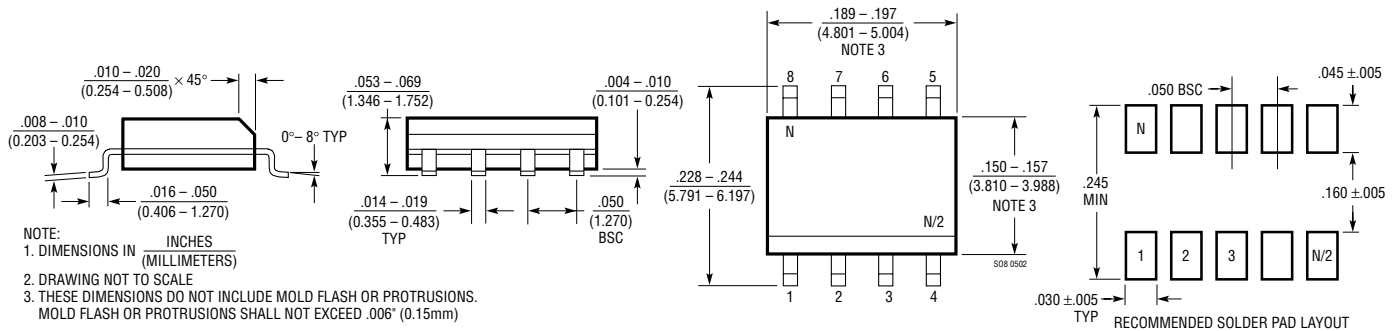

NOTE:  
1. DIMENSIONS IN  $\frac{\text{INCHES}}{\text{MILLIMETERS}}$   
2. DRAWING NOT TO SCALE  
3. THESE DIMENSIONS DO NOT INCLUDE MOLD FLASH OR PROTRUSIONS.  
MOLD FLASH OR PROTRUSIONS SHALL NOT EXCEED .006" (0.15mm)

# RELATED PARTS

PART NUMBER	DESCRIPTION	COMMENTS
LTC486	Quad RS485 Driver	Fits 75172 Pinout, Only 110µA I <sub>Q</sub>
LTC488	Quad RS485 Receiver	Fits 75173 Pinout, Only 7µA I <sub>Q</sub>
LTC490	Full Duplex RS485 Transceiver	Fits 75179 Pinout, Only 300µA I <sub>Q</sub>
LTC1485	Differential Bus Transceiver	Fits 75176A Pinout, Only 1.7mA I <sub>Q</sub>