

## FEATURES

- Simultaneously Monitors 5V, 3.3V and Adjustable Inputs
- Guaranteed Threshold Accuracy:  $\pm 0.75\%$
- Low Supply Current: 100 $\mu$ A
- Internal Reset Time Delay: 200ms
- Manual Pushbutton Reset Input
- Active Low and Active High Reset Outputs
- Active Low “Soft” Reset Output
- Power Supply Glitch Immunity
- Guaranteed Reset for Either  $V_{CC3} \geq 1V$  or  $V_{CC5} \geq 1V$
- Meets PCI  $t_{FAIL}$  Timing Specifications Rev 2.1
- 8-Pin SO and MSOP Packages

## APPLICATIONS

- PCI-Based Systems
- Desktop Computers
- Notebook Computers
- Intelligent Instruments
- Portable Battery-Powered Equipment
- Network Servers

## DESCRIPTION

The LTC<sup>®</sup>1536 is designed for PCI local bus applications with multiple supply voltages that require low power, small size, high speed and high accuracy supply monitoring.

For 3.3V and 5V supplies that are >500mV below spec or for the condition when the 5V supply falls below the 3.3V supply, the LTC1536 has a very fast response time capable of meeting the PCI  $t_{FAIL}$  timing specification. Tight 0.75% threshold accuracy and glitch immunity ensure reliable reset operation without false triggering.

The  $\overline{RST}$  output is guaranteed to be in the correct state for  $V_{CC5}$  or  $V_{CC3}$  down to 1V. The 100 $\mu$ A typical supply current makes the LTC1536 ideal for power-conscious systems.

A manual pushbutton reset input provides the ability to generate a very narrow “soft” reset pulse (100 $\mu$ s typ) or a 200ms reset pulse equivalent to a power-on reset. Both  $\overline{SRST}$  and  $\overline{RST}$  outputs are open-drain and can be OR-tied with other reset sources.

LTC, LTC and LT are registered trademarks of Linear Technology Corporation. All other trademarks are the property of their respective owners.

## TYPICAL APPLICATION

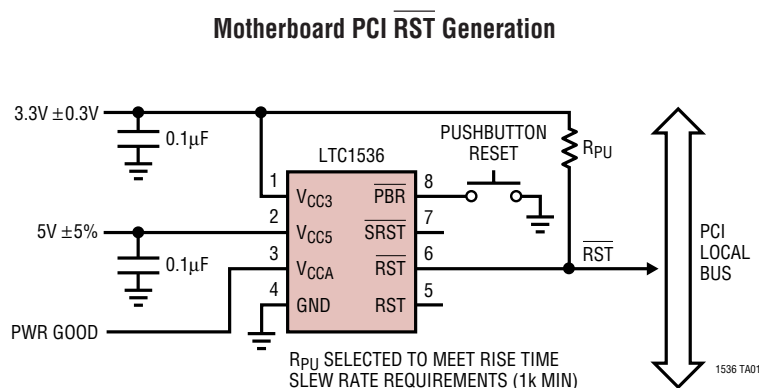

**Power Fail Waveform  
 5V Dropping Below 3.3V by 300mV**

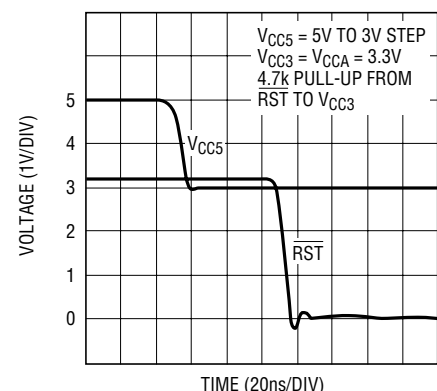

## ABSOLUTE MAXIMUM RATINGS (Notes 1, 2)

Terminal Voltage	Operating Temperature Range
$V_{CC3}, V_{CC5}, V_{CCA}$ ..... -0.3V to 7V	LTC1536C ..... 0°C to 70°C
$\overline{RST}, \overline{SRST}$ ..... -0.3V to 7V	LTC1536I ..... -40°C to 85°C
$\overline{RST}$ ..... -0.3V to $V_{CC3} + 0.3V$	Storage Temperature Range ..... -65°C to 150°C
$\overline{PBR}$ ..... -7V to 7V	Lead Temperature (Soldering, 10 sec) ..... 300°C

## PACKAGE/ORDER INFORMATION

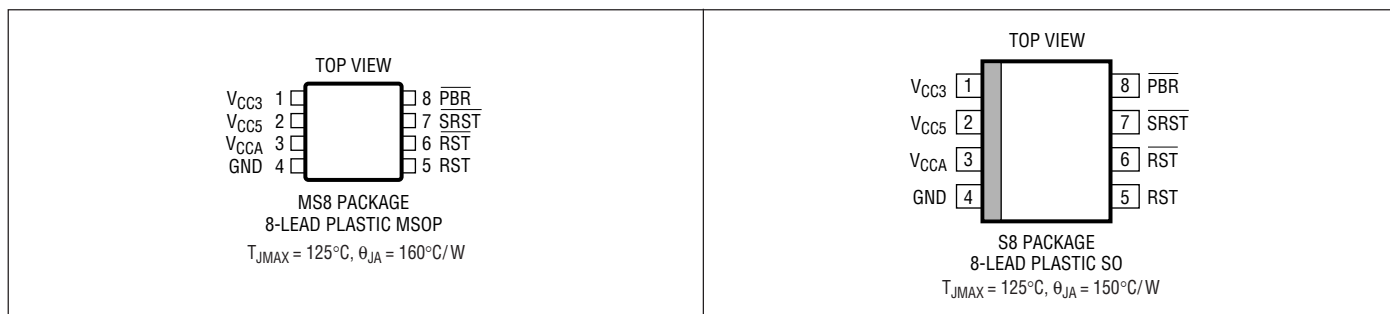

ORDER PART NUMBER	MS8 PART MARKING	ORDER PART NUMBER	S8 PART MARKING
LTC1536CMS8	LTBV	LTC1536CS8	1536
		LTC1536IS8	1536I

**Order Options** Tape and Reel: Add #TR  
 Lead Free: Add #PBF Lead Free Tape and Reel: Add #TRPBF  
 Lead Free Part Marking: <http://www.linear.com/leadfree/>

Consult LTC Marketing for parts specified with wider operating temperature ranges.

## ELECTRICAL CHARACTERISTICS

The ● denotes the specifications which apply over the full operating temperature range, otherwise specifications are at  $T_A = 25^\circ\text{C}$ .  $V_{CC3} = 3.3\text{V}$ ,  $V_{CC5} = 5\text{V}$ ,  $V_{CCA} = V_{CC3}$  unless otherwise noted.

SYMBOL	PARAMETER	CONDITIONS	MIN	TYP	MAX	UNITS	
$V_{RT3}$	Reset Threshold $V_{CC3}$	$0^\circ\text{C} \leq T_A \leq 70^\circ\text{C}$	●	2.962	2.985	3.000	V
		$-40^\circ\text{C} \leq T_A \leq 85^\circ\text{C}$	●	2.925	2.985	3.008	V
$V_{RT5}$	Reset Threshold $V_{CC5}$	$0^\circ\text{C} \leq T_A \leq 70^\circ\text{C}$	●	4.687	4.725	4.750	V
		$-40^\circ\text{C} \leq T_A \leq 85^\circ\text{C}$	●	4.625	4.725	4.762	V
$V_{RTA}$	Reset Threshold $V_{CCA}$	$0^\circ\text{C} \leq T_A \leq 70^\circ\text{C}$	●	0.992	1.000	1.007	V
		$-40^\circ\text{C} \leq T_A \leq 85^\circ\text{C}$	●	0.980	1.000	1.007	V
$V_{CC}$	$V_{CC3}$ or $V_{CC5}$ Operating Voltage	$\overline{RST}$ in Correct Logic State	●	1	7	V	
$I_{VCC3}$	$V_{CC3}$ Supply Current	$\overline{PBR} = V_{CC3}$	●	100	200	$\mu\text{A}$	
$I_{VCC5}$	$V_{CC5}$ Input Current	$V_{CC5} = 5\text{V}$	●	10	20	$\mu\text{A}$	
$I_{VCCA}$	$V_{CCA}$ Input Current	$V_{CCA} = 1\text{V}$	●	-15	0	nA	
$t_{RST}$	Reset Pulse Width	$\overline{RST}$ Low with 10k $\Omega$ Pull-Up to $V_{CC3}$	●	140	200	280	ms
		$0^\circ\text{C}$ to $70^\circ\text{C}$ $-40^\circ\text{C}$ to $85^\circ\text{C}$	●	140	200	300	ms
$t_{SRST}$	Soft Reset Pulse Width	$\overline{SRST}$ Low with 10k $\Omega$ Pull-Up to $V_{CC3}$	●	50	100	200	$\mu\text{s}$
$t_{UV}$	$V_{CC}$ Undervoltage Detect to $\overline{RST}$	$V_{CC5}, V_{CC3}$ or $V_{CCA}$ Less Than Reset Threshold $V_{RT}$ by 1%		13		$\mu\text{s}$	

## ELECTRICAL CHARACTERISTICS

The ● denotes the specifications which apply over the full operating temperature range, otherwise specifications are at  $T_A = 25^\circ\text{C}$ .  $V_{CC3} = 3.3\text{V}$ ,  $V_{CC5} = 5\text{V}$ ,  $V_{CCA} = V_{CC3}$  unless otherwise noted.

SYMBOL	PARAMETER	CONDITIONS	MIN	TYP	MAX	UNITS	
$I_{PBR}$	PBR Pull-Up Current	$\overline{PBR} = 0\text{V}$ , $0^\circ\text{C} \leq T_A \leq 70^\circ\text{C}$	●	3	7	10	$\mu\text{A}$
		$\overline{PBR} = 0\text{V}$ , $-40^\circ\text{C} \leq T_A \leq 85^\circ\text{C}$	●	3	7	15	$\mu\text{A}$
$V_{IL}$	$\overline{PBR}$ , $\overline{RST}$ Input Low Voltage		●		0.8	V	
$V_{IH}$	$\overline{PBR}$ , $\overline{RST}$ Input High Voltage		●	2		V	
$t_{PW}$	$\overline{PBR}$ Min Pulse Width		●	40		ns	
$t_{DB}$	$\overline{PBR}$ Debounce	Deassertion of $\overline{PBR}$ Input to $\overline{SRST}$ Output (PBR Pulse Width = $1\mu\text{s}$ )	●	20	35	ms	
$t_{PB}$	PBR Assertion Time for Transition from Soft to Hard Reset Mode	$\overline{PBR}$ Held Less Than $V_{IL}$ , $0^\circ\text{C}$ to $70^\circ\text{C}$	●	1.4	2.0	2.8	s
		$\overline{PBR}$ Held Less Than $V_{IL}$ , $-40^\circ\text{C}$ to $85^\circ\text{C}$	●	1.4	2.0	3.0	s
$V_{OL}$	RST Output Voltage Low	$I_{SINK} = 5\text{mA}$	●	0.15	0.4	V	
		$I_{SINK} = 100\mu\text{A}$ $0^\circ\text{C} \leq T_A \leq 70^\circ\text{C}$	$V_{CC3} = 1\text{V}$ , $V_{CC5} = 0\text{V}$	●	0.05	0.4	V
			$V_{CC3} = 0\text{V}$ , $V_{CC5} = 1\text{V}$	●	0.05	0.4	V
			$V_{CC3} = 1\text{V}$ , $V_{CC5} = 1\text{V}$	●	0.05	0.4	V
	$I_{SINK} = 100\mu\text{A}$ $-40^\circ\text{C} \leq T_A \leq 85^\circ\text{C}$	$V_{CC3} = 1.1\text{V}$ , $V_{CC5} = 0\text{V}$	●	0.05	0.4	V	
		$V_{CC3} = 0\text{V}$ , $V_{CC5} = 1.1\text{V}$	●	0.05	0.4	V	
	$V_{CC3} = 1.1\text{V}$ , $V_{CC5} = 1.1\text{V}$	●	0.05	0.4	V		
	SRST Output Voltage Low	$I_{SINK} = 2.5\text{mA}$	●	0.15	0.4	V	
	RST Output Voltage Low	$I_{SINK} = 2.5\text{mA}$	●	0.15	0.4	V	
$V_{OH}$	RST Output Voltage High (Note 3)	$I_{SOURCE} = 1\mu\text{A}$	●	$V_{CC3} - 1$		V	
	SRST Output Voltage High (Note 3)	$I_{SOURCE} = 1\mu\text{A}$	●	$V_{CC3} - 1$		V	
	RST Output Voltage High	$I_{SOURCE} = 600\mu\text{A}$	●	$V_{CC3} - 1$		V	
$t_{PHL}$	Propagation Delay $\overline{RST}$ to RST High Input to Low Output	$C_{RST} = 20\text{pF}$		25		ns	
$t_{PLH}$	Propagation Delay $\overline{RST}$ to RST Low Input to High Output	$C_{RST} = 20\text{pF}$		45		ns	
$t_{FAIL}$	$V_{CC5}$ or $V_{CC3}$ 0.5V Undervoltage to RST (Note 4)	$V_{CC5}$ Drops Below 4.25V or $V_{CC3}$ Drops Below 2.5V (Note 5)	●	150	450	ns	
$t_{PF}$	$V_{CC5} < (V_{CC3} - 300\text{mV})$ $\overline{RST}$ (Note 4)	$V_{CC5}$ Drops Below $V_{CC3}$ By 300mV (Note 6)	●	50	90	ns	

**Note 1:** Stresses beyond those listed under Absolute Maximum Ratings may cause permanent damage to the device. Exposure to any Absolute Maximum Rating condition for extended periods may affect device reliability and lifetime.

**Note 2:** All voltage values are with respect to GND.

**Note 3:** The output pins  $\overline{SRST}$  and  $\overline{RST}$  have weak internal pull-ups to  $V_{CC3}$  of  $6\mu\text{A}$ . However, external pull-up resistors may be used when faster rise times are required.

**Note 4:** Conforms to PCI Local Bus Specification Rev 2.1, Sect. 4.3.2 for  $t_{FAIL}$ .

**Note 5:**  $V_{CC3}$  or  $V_{CC5}$  falling at  $-0.1\text{V}/\mu\text{s}$ , time measured from  $V_{RTX} - 500\text{mV}$  to RST at 1.5V.

**Note 6:**  $V_{CC5}$  falling from 5V to 3V in  $\leq 10\text{ns}$ , time measured from  $V_{CC5} = (V_{CC3} - 300\text{mV})$  to  $\overline{RST}$  at 1.5V.

# TYPICAL PERFORMANCE CHARACTERISTICS

**I<sub>VCC3</sub> vs Temperature**

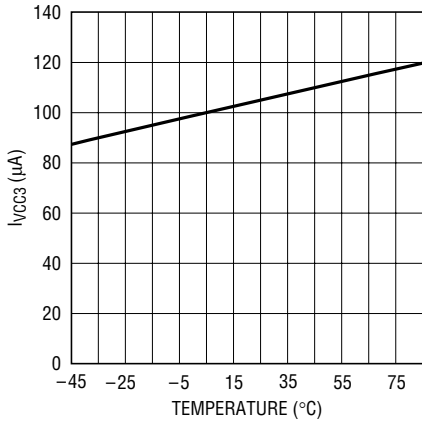

1536 G01

**I<sub>VCC5</sub> vs Temperature**

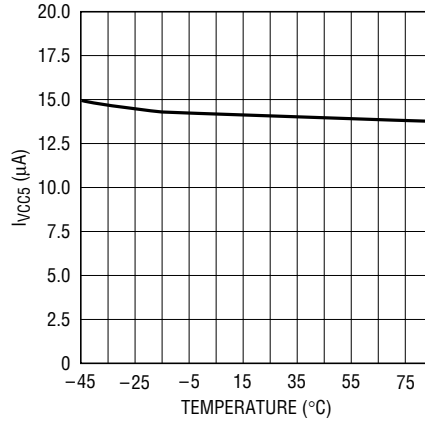

1536 G02

**V<sub>CCA</sub> Input Current vs Input Voltage**

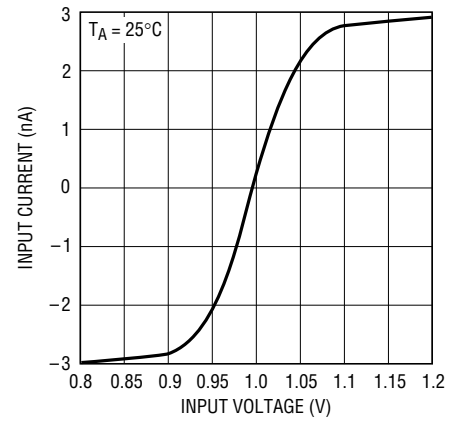

1536 G03

**V<sub>CC5</sub> Threshold Voltage vs Temperature**

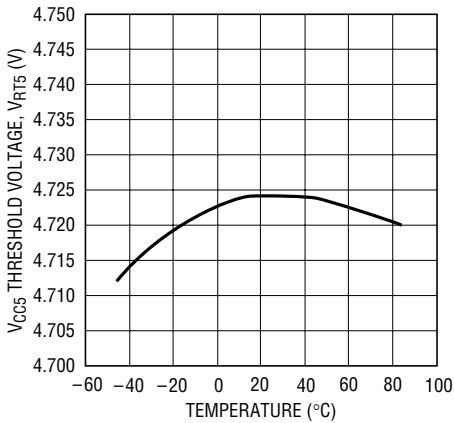

1536 G04

**V<sub>CC3</sub> Threshold Voltage vs Temperature**

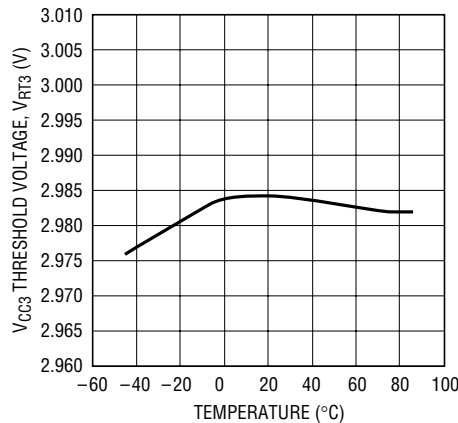

1536 G05

**V<sub>CCA</sub> Threshold Voltage vs Temperature**

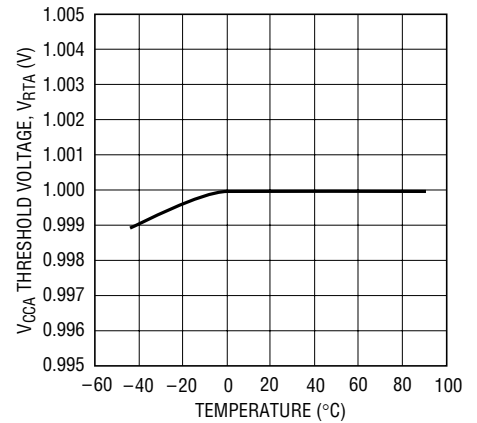

1536 G06

**Reset Pulse Width vs Temperature**

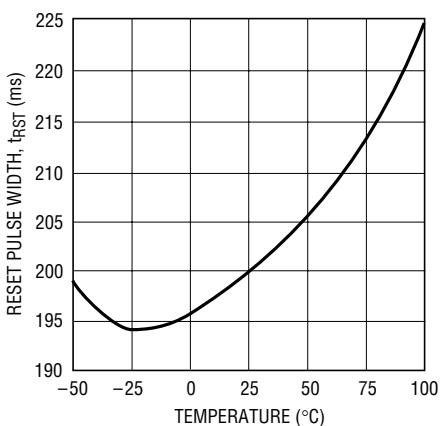

1536 G07

**“Soft” Reset Pulse Width vs Temperature**

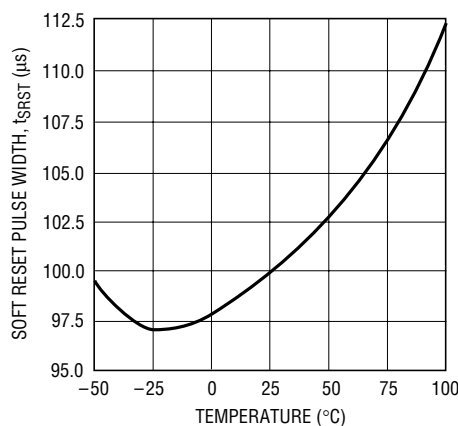

1536 G08

**PBR Assertion Time to Reset vs Temperature**

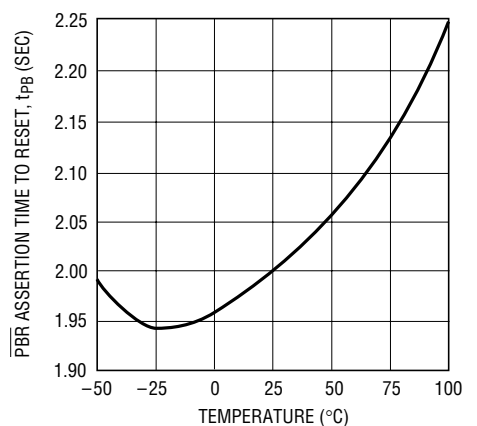

1536 G09

1536fa

# TYPICAL PERFORMANCE CHARACTERISTICS

**V<sub>CC3</sub> Typical Transient Duration vs Reset Comparator Overdrive**

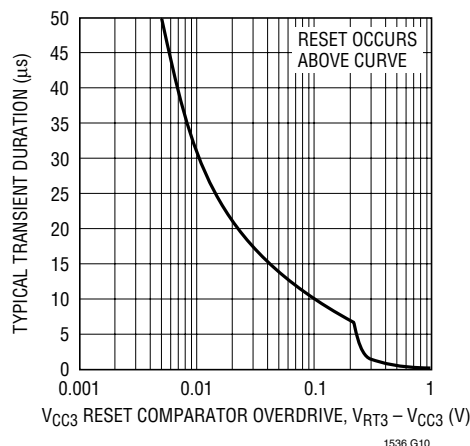

**V<sub>CC5</sub> Typical Transient Duration vs Reset Comparator Overdrive**

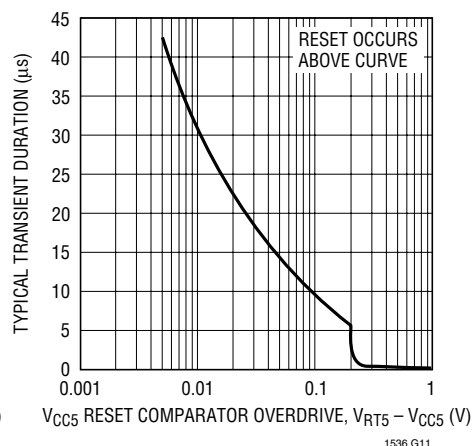

**V<sub>CCA</sub> Typical Transient Duration vs Reset Comparator Overdrive**

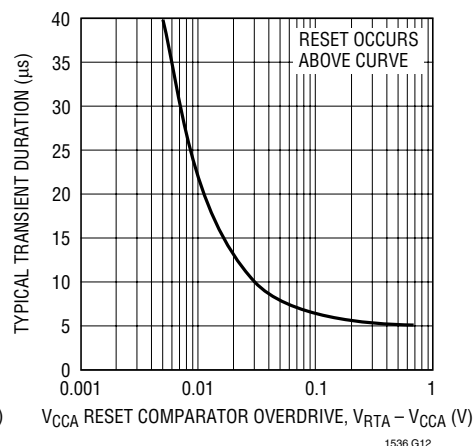

**RST Output Voltage vs Supply Voltage**

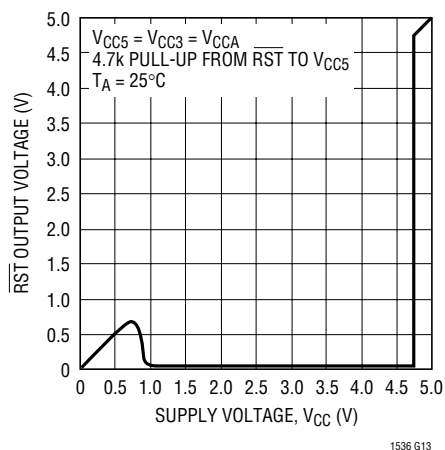

**RST Output Voltage vs Supply Voltage**

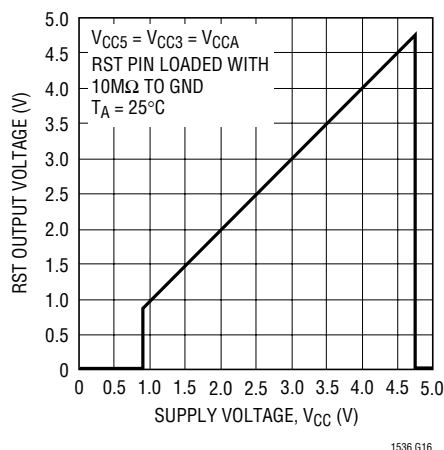

**Undervoltage Response Time vs Temperature**

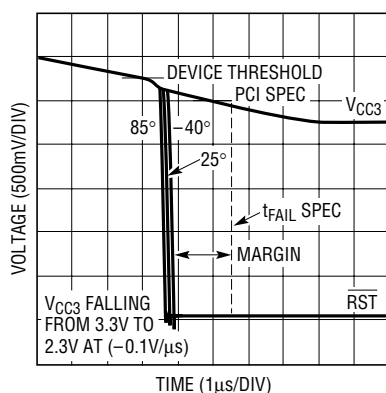

**Power-Fail Response Time vs Temperature**

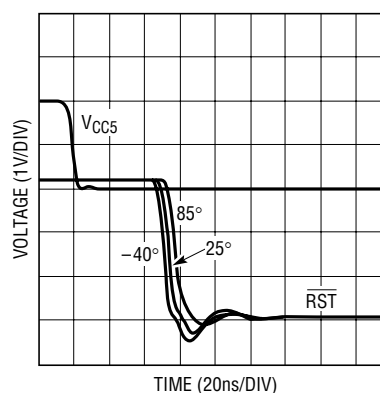

## PIN FUNCTIONS

**V<sub>CC3</sub> (Pin 1):** 3.3V Sense Input and Power Supply Pin for the IC. Bypass to ground with  $\geq 0.1\mu\text{F}$  ceramic capacitor.

**V<sub>CC5</sub> (Pin 2):** 5V Sense Input. Used as gate drive for  $\overline{\text{RST}}$  output FET when the voltage on V<sub>CC5</sub> is greater than the voltage on V<sub>CC3</sub>.

**V<sub>CCA</sub> (Pin 3):** 1V Sense, High Impedance Input. Can be used as a logic input with a 1V threshold. If unused it can be tied to either V<sub>CC3</sub> or V<sub>CC5</sub>.

**GND (Pin 4):** Ground.

**RST (Pin 5):** Reset Logic Output. Active high CMOS logic output, drives high to V<sub>CC3</sub>, buffered compliment of  $\overline{\text{RST}}$ . An external pull-down on the  $\overline{\text{RST}}$  pin will drive this pin high.

**$\overline{\text{RST}}$  (Pin 6):** Reset Logic Output. Active low, open-drain logic output with weak pull-up to V<sub>CC3</sub>. Can be pulled up greater than V<sub>CC3</sub> when interfacing to 5V logic.

Asserted when one or more of the supplies are below trip thresholds and held for 200ms after all supplies become valid. Also asserted after  $\overline{\text{PBR}}$  is held low for more than two seconds and for an additional 200ms after  $\overline{\text{PBR}}$  is released.

**SRST (Pin 7):** “Soft” Reset. Active low, open-drain logic output with weak pull-up to V<sub>CC3</sub>. Can be pulled up greater than V<sub>CC3</sub> when interfacing to 5V logic. Asserted for 100 $\mu\text{s}$  after  $\overline{\text{PBR}}$  is held low for less than two seconds and released.

**$\overline{\text{PBR}}$  (Pin 8):** Pushbutton Reset. Active low logic input with weak pull-up to V<sub>CC3</sub>. Can be pulled up greater than V<sub>CC3</sub> when interfacing to 5V logic. When asserted for less than two seconds, outputs a soft reset 100 $\mu\text{s}$  pulse on the SRST pin. When  $\overline{\text{PBR}}$  is asserted for greater than two seconds, the  $\overline{\text{RST}}$  output is forced low and remains low until 200ms after  $\overline{\text{PBR}}$  is released.

## BLOCK DIAGRAM

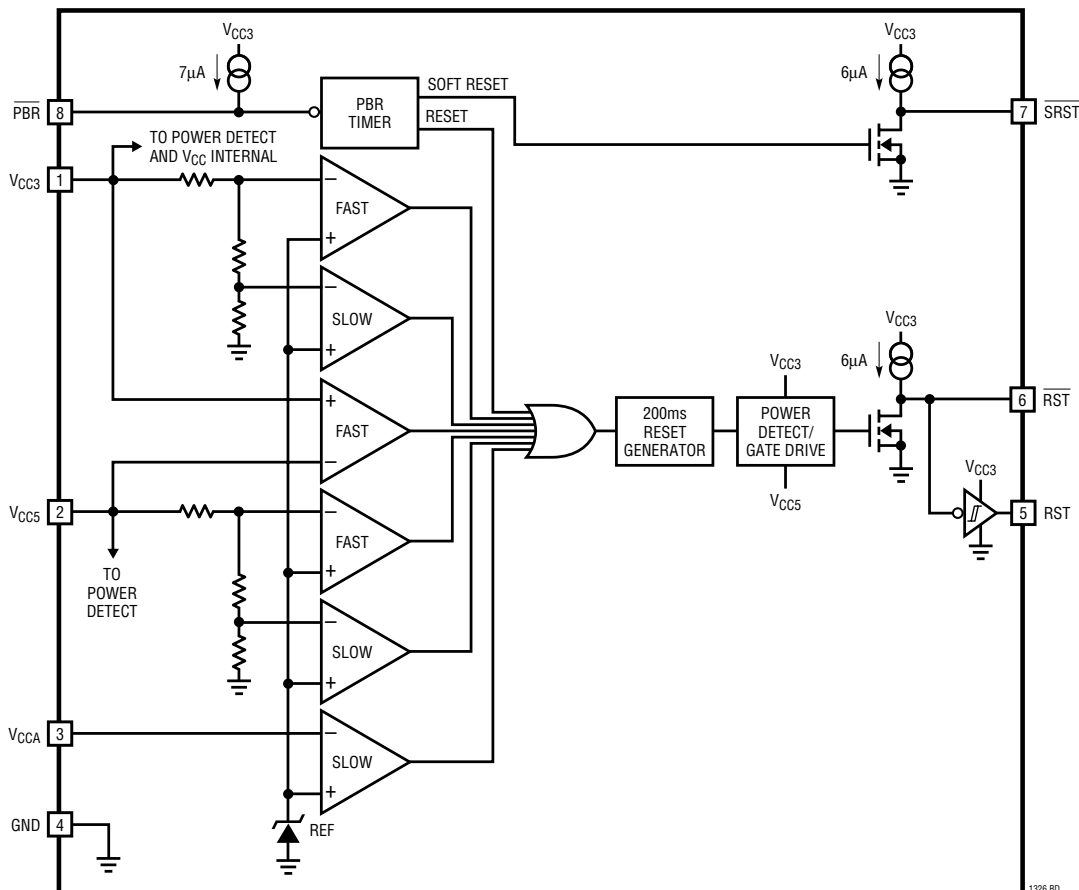

## TIMING DIAGRAMS

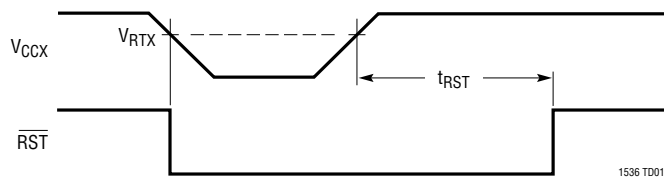
V<sub>CC</sub> Monitor Timing

Pushbutton Reset Function Timing

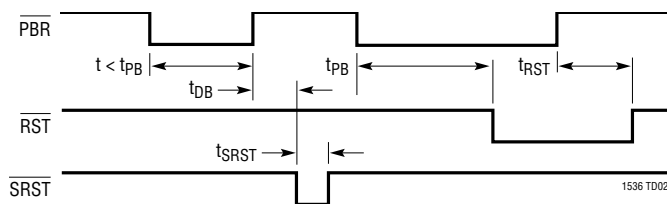
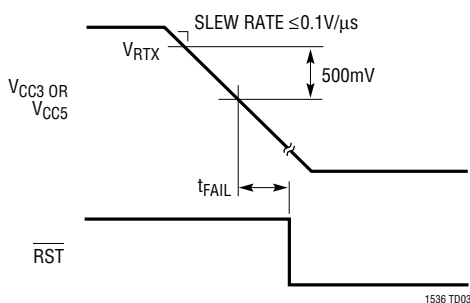
t<sub>FAIL</sub> Fast Undervoltage Detect

Power-Fail Detect

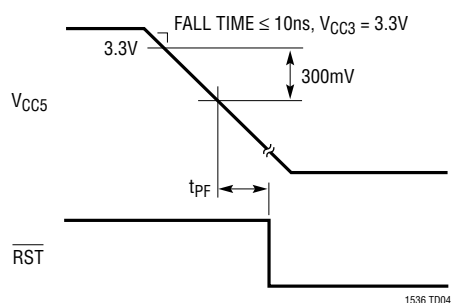

## APPLICATIONS INFORMATION

## Operation

The LTC1536 is a low power, high accuracy triple supply monitoring circuit. This reset generator has two basic functions: generation of a reset when power supplies are out of range, and generation of a reset or “soft” reset when the reset button is pushed. The LTC1536 has the added feature that when the reset supplies are grossly undervoltage there is a very short delay from undervoltage detect to assertion of  $\overline{RST}$ .

## Supply Monitoring

All three V<sub>CC</sub> inputs must be above predetermined thresholds for 200ms before the reset output is released. The LTC1536 will assert reset during power-up, power-down and brownout conditions on any one or more of the V<sub>CC</sub> inputs.

On power-up, either the V<sub>CC5</sub> or V<sub>CC3</sub> pin can power the drive circuits for the  $\overline{RST}$  pin. This ensures that  $\overline{RST}$  will

be low when either V<sub>CC5</sub> or V<sub>CC3</sub> reaches 1V. As long as any one of the V<sub>CC</sub> inputs is below its predetermined threshold,  $\overline{RST}$  will stay a logic low. Once all of the V<sub>CC</sub> inputs rise above their thresholds, an internal timer is started and  $\overline{RST}$  is released after 200ms.  $\overline{RST}$  outputs the inverted state of what is seen on  $\overline{RST}$ .

$\overline{RST}$  is reasserted whenever any one of the V<sub>CC</sub> inputs drops below its predetermined threshold and remains asserted until 200ms after all of the V<sub>CC</sub> inputs are above their thresholds.

On power-down, once any of the V<sub>CC</sub> inputs drops below its threshold,  $\overline{RST}$  is held at a logic low. A logic low of 0.4V is guaranteed until V<sub>CC3</sub> and V<sub>CC5</sub> drops below 1V.

## Pushbutton Reset

The LTC1536 provides a pushbutton reset input pin. The  $\overline{PBR}$  input has an internal pull-up current source to V<sub>CC3</sub>. If the  $\overline{PBR}$  pin is not used it can be left floating.

## APPLICATIONS INFORMATION

When the  $\overline{\text{PBR}}$  is pulled low for less than  $t_{\text{PB}} (\approx 2 \text{ sec})$ , a narrow ( $100\mu\text{s}$  typ) soft reset pulse is generated on the  $\overline{\text{SRST}}$  output pin after the button is released. The push-button circuitry contains an internal debounce counter which delays the output of the soft reset pulse by typically 20ms. This pin can be OR-tied to the  $\overline{\text{RST}}$  pin and issue what is called a “soft” reset. The  $\overline{\text{SRST}}$  thereby resets the microprocessor without interrupting the DRAM refresh cycle. In this manner DRAM information remains undisturbed. Alternatively,  $\overline{\text{SRST}}$  may be monitored by the processor to initiate a software-controlled reset.

When the  $\overline{\text{PBR}}$  pin is held low for longer than  $t_{\text{PB}} (\approx 2 \text{ sec})$ , a standard reset is generated. Once the 2-second period has elapsed, a reset signal is produced by the pushbutton logic, thereby clearing the reset counter. Once the  $\overline{\text{PBR}}$  pin is released, the reset counter begins counting the reset period (200ms nominal). Consequently, the reset outputs remain asserted for approximately 200ms after the button is released.

### Fast Undervoltage for PCI Applications

The LTC1536 is designed for PCI Local Bus applications that require reset to be asserted quickly in response to one or both of the power supply rails (5V and 3.3V) going out of spec. The spec for  $t_{\text{FAIL}}$  and  $t_{\text{PF}}$  are met with enough margin to give the designer the ability to add follow-on logic as needed by system requirements. The  $V_{\text{CCA}}$  pin can be used to monitor the “power good” signal and keep reset applied until both supplies are in spec and the power good signal is high.

### Glitch Immunity and Fast Undervoltage Detection

The LTC1536 achieves its high speed characteristics while maintaining glitch immunity by using two sets of comparators. The  $V_{\text{CC5}}$  and  $V_{\text{CC3}}$  sense inputs each have two comparators set at different thresholds. A slow, very accurate comparator monitors the supply for precision undervoltage detection. In parallel, but with a threshold 250mV lower than the precision threshold, is a very fast comparator that detects when the supply is quickly going out of specification. Because the fast comparator threshold is set 250mV above the PCI specification, typical values for  $t_{\text{FAIL}}$  can be negative.

### 3V or 5V Power Detect/Gate Drive

The LTC1536 for the most part is powered internally from the  $V_{\text{CC3}}$  pin. The exception is at the gate drive of the output FET on the  $\overline{\text{RST}}$  pin. On the gate to this FET is power detect circuitry used to detect and drive the gate from either the 3.3V pin or the 5V pin, whichever pin has the highest potential. This ensures the part pulls the  $\overline{\text{RST}}$  pin low as soon as either input pin is  $\geq 1\text{V}$ .

### Extended ESD Tolerance of the $\overline{\text{PBR}}$ Input Pin

The  $\overline{\text{PBR}}$  pin is susceptible to ESD since it can be brought out to a front panel in normal applications. The ESD tolerance of this pin can be increased by adding a resistor in series with the  $\overline{\text{PBR}}$  pin. A 10k resistor can increase the ESD tolerance of the  $\overline{\text{PBR}}$  pin to approximately 10kV. The  $\overline{\text{PBR}}$ 's internal pull-up current of  $7\mu\text{A}$  typical means there is only 70mV (150mV max) dropped across the resistor.

## TYPICAL APPLICATIONS

PCI Expansion Board  $\overline{\text{RST}}$  Generation

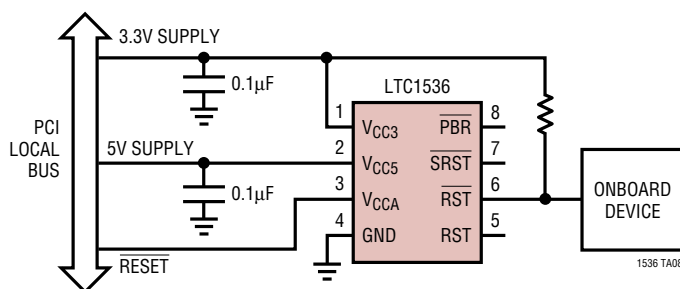

Dual Supply Monitor (3.3V and 5V,  $V_{\text{CCA}}$  Input Monitoring “Power Good”)

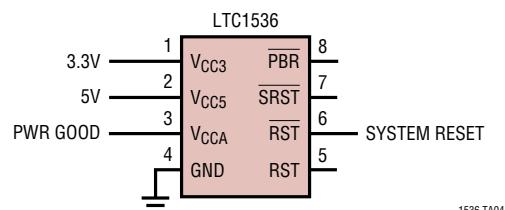

1536fa



# TYPICAL APPLICATIONS

**Triple Supply Monitor (3.3V, 5V and Adjustable)**

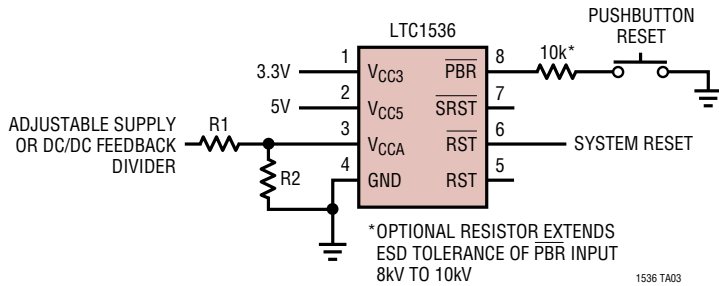

**RESET Valid for V<sub>CC3</sub> Down to 0V in a Dual Supply Application**

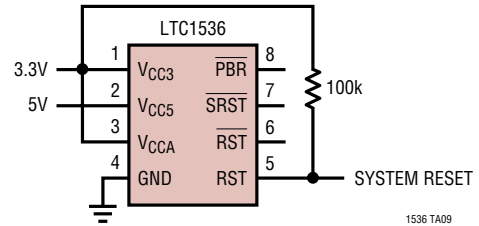

**SRST Tied to RST and OR-Tying Other Sources to RST to Generate Reset and Reset**

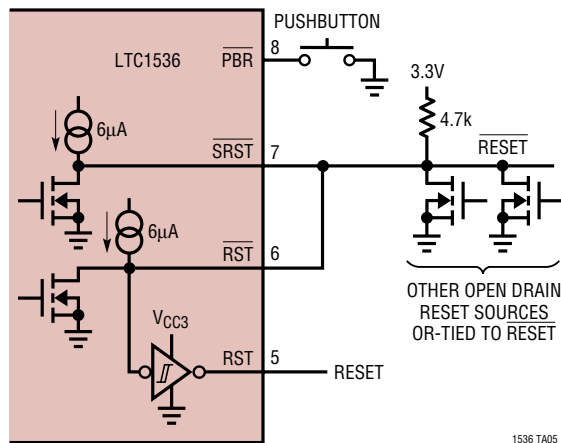

**Using V<sub>CCA</sub> Tied to DC/DC Feedback Divider**

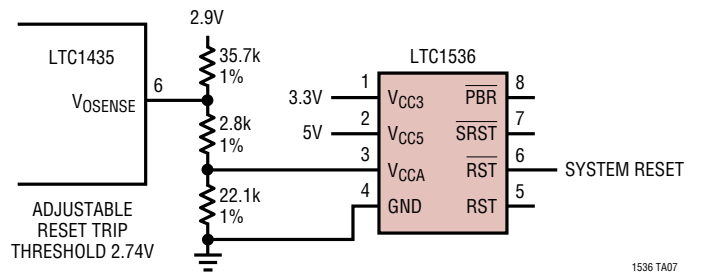

# PACKAGE DESCRIPTION

**MS8 Package**  
**8-Lead Plastic MSOP**  
 (Reference LTC DWG # 05-08-1660)

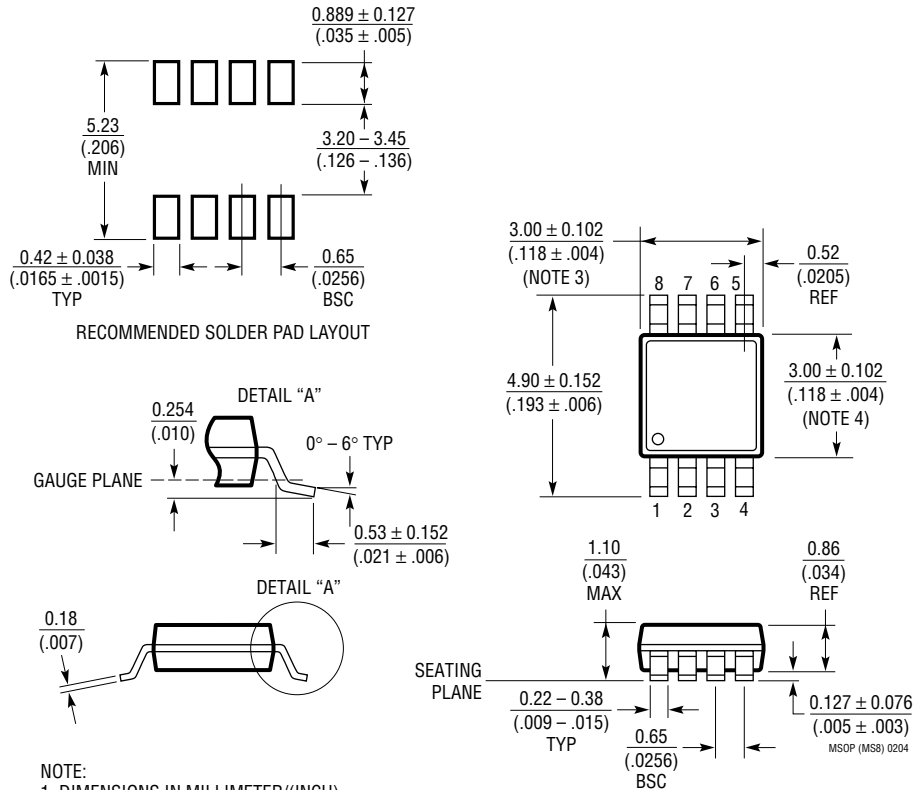

- NOTE:
1. DIMENSIONS IN MILLIMETER/(INCH)
  2. DRAWING NOT TO SCALE
  3. DIMENSION DOES NOT INCLUDE MOLD FLASH, PROTRUSIONS OR GATE BURRS. MOLD FLASH, PROTRUSIONS OR GATE BURRS SHALL NOT EXCEED 0.152mm (.006") PER SIDE
  4. DIMENSION DOES NOT INCLUDE INTERLEAD FLASH OR PROTRUSIONS. INTERLEAD FLASH OR PROTRUSIONS SHALL NOT EXCEED 0.152mm (.006") PER SIDE
  5. LEAD COPLANARITY (BOTTOM OF LEADS AFTER FORMING) SHALL BE 0.102mm (.004") MAX

# PACKAGE DESCRIPTION

## S8 Package 8-Lead Plastic Small Outline (Narrow .150 Inch) (Reference LTC DWG # 05-08-1610)

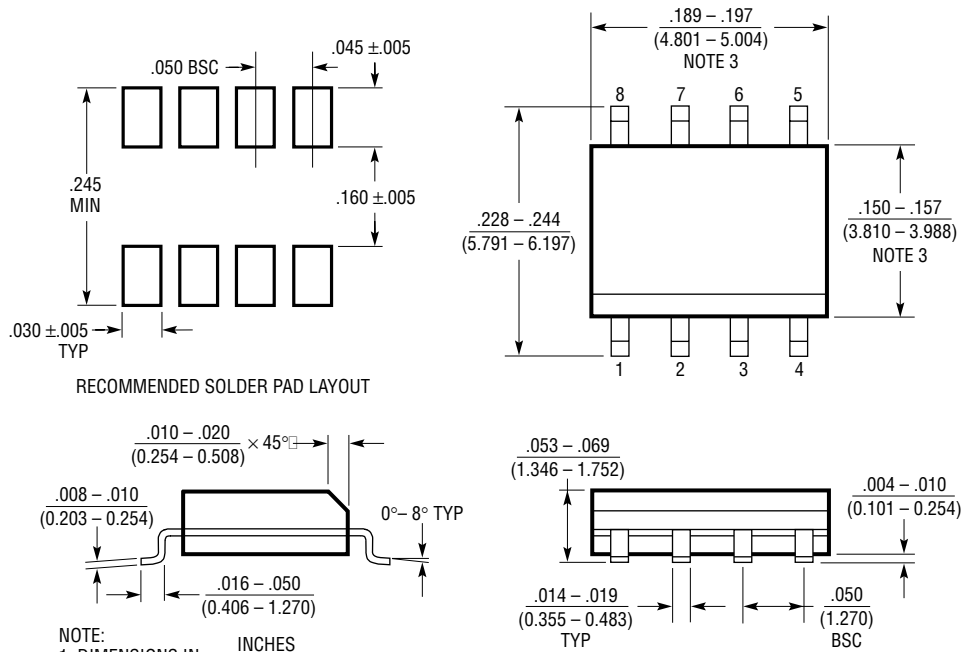

- NOTE:  
1. DIMENSIONS IN INCHES (MILLIMETERS)  
2. DRAWING NOT TO SCALE  
3. THESE DIMENSIONS DO NOT INCLUDE MOLD FLASH OR PROTRUSIONS. MOLD FLASH OR PROTRUSIONS SHALL NOT EXCEED .006" (0.15mm)

S08 0303

# TYPICAL APPLICATIONS

**Quad Supply Monitor:**  
 12V: Undervoltage, Overvoltage  
 5V: Undervoltage, Overvoltage  
 3.3V: Undervoltage, Overvoltage  
 -12V: Undervoltage

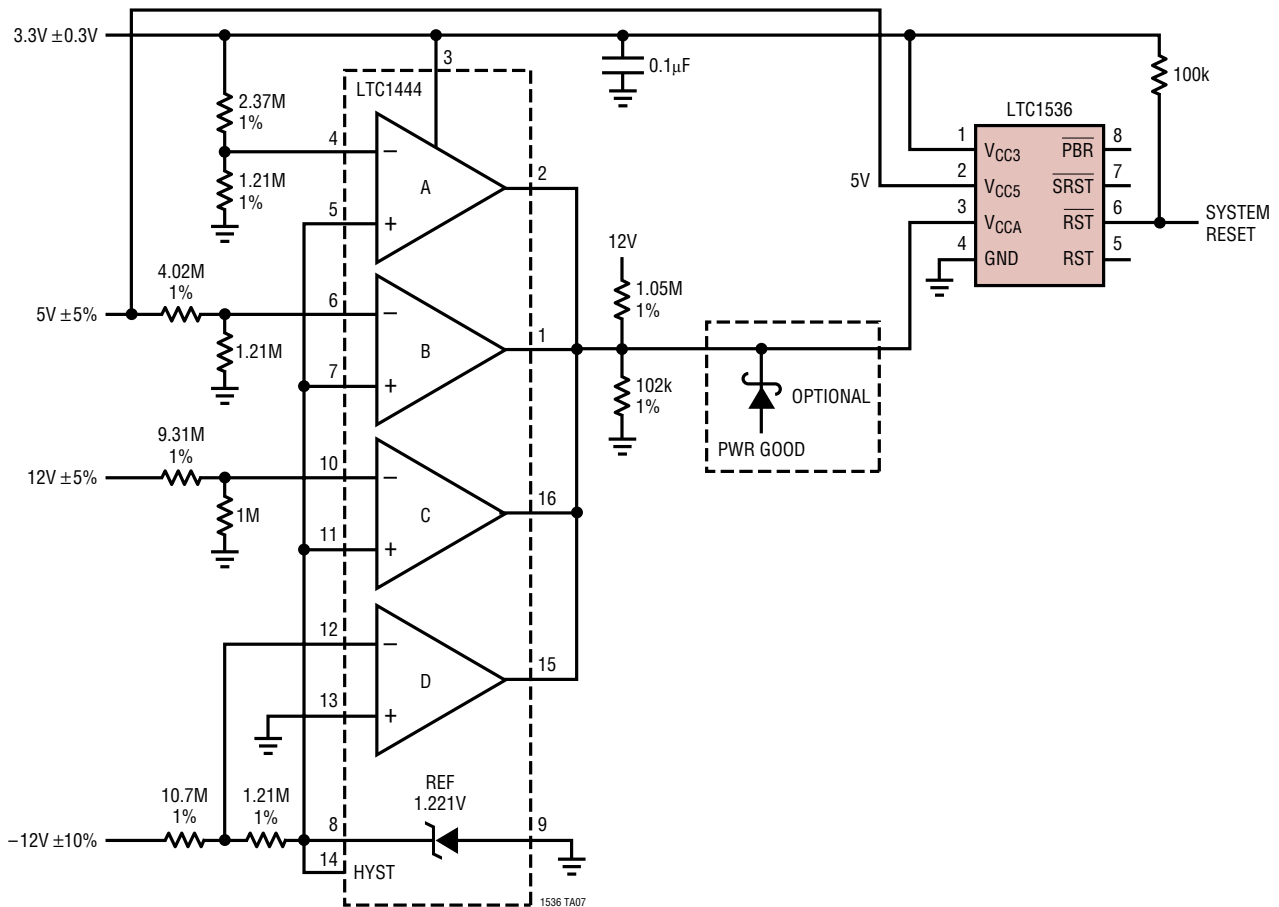

## RELATED PARTS

PART NUMBER	DESCRIPTION	COMMENTS
LTC690	5V Supply Monitor, Watchdog Timer and Battery Backup	4.65V Threshold
LTC694-3.3	3.3V Supply Monitor, Watchdog Timer and Battery Backup	2.9V Threshold
LTC699	5V Supply Monitor and Watchdog Timer	4.65V Threshold
LTC1232	5V Supply Monitor, Watchdog Timer and Pushbutton Reset	4.37V/4.62V Threshold
LTC1326	Micropower Precision Triple Supply Monitor	4.725V, 3.118V, 1V Thresholds (±0.75%)
LTC1326-2.5	Micropower Precision Triple Supply Monitor	2.363V, 3.118V, 1V Thresholds (±0.75%)