

FEATURES

- Complete SMBus/I²C™ Brushless DC Fan Speed Control System in a 5-Pin SOT-23 package
- 0.75Ω PMOS Linear Regulator with 180mA Output Current Rating
- 0V to 4.922V Output Voltage Range Controlled by a 6-Bit DAC
- Simple 2-Wire SMBus/I²C Interface
- 250ms Internal Timer Ensures Fan Start-Up
- Current Limit and Thermal Shutdown
- Fault Status Indication via SMBus Host Readback

APPLICATIONS

- Notebook Computers
- Spot Cooling
- Portable Instruments
- Battery-Powered Systems
- DC Motor Control
- White LED Power Supplies
- Programmable Low Dropout Regulator

DESCRIPTION

The LTC[®]1695 fan speed controller provides all the functions necessary for a power management microprocessor to regulate the speed of a 5V brushless DC fan via a 2-wire SMBus/I²C interface. Fan speed is controlled according to the system's required temperature profile and permits lower fan power consumption, longer battery run time and lower acoustical generated noise versus systems that only provide simple on-off control for the fan.

The LTC1695 incorporates a 180mA low dropout linear regulator, a 2-wire SMBus/I²C interface and a 6-bit DAC. Fan speed is controlled by varying the fan's terminal voltage through the output voltage of the LTC1695's linear regulator. The LTC1695's output voltage is programmed by sending a 6-bit digital code to the LTC1695 DAC via the SMBus. To eliminate fan start-up problems at lower fan voltages, users can enable the LTC1695's boost start feature that provides the DAC's full-scale output voltage for 250ms before decreasing to the programmed output voltage.

The LTC1695 includes output current limiting and thermal shutdown as well as status monitors that can be read back by the microprocessor during fault conditions. The LTC1695 is available in a 5-lead SOT-23 package.

LT, LTC and LT are registered trademarks of Linear Technology Corporation.
 I²C is a trademark of Philips Electronics N.V.

TYPICAL APPLICATION

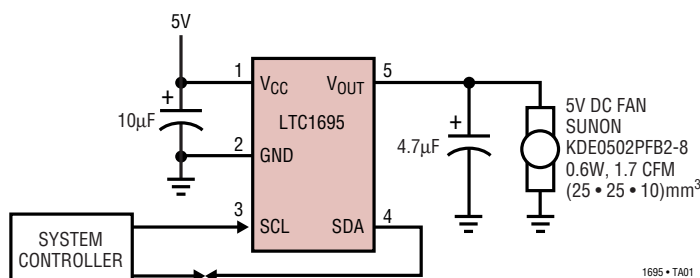

1695 • TA01

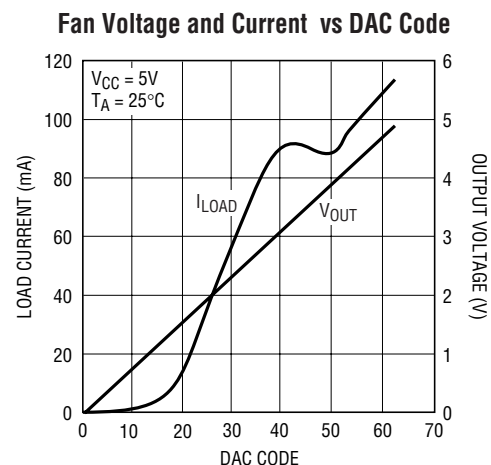

1695 • TA02

ABSOLUTE MAXIMUM RATINGS

(Note 1)

Terminal Voltages

| | |
|--------------------------------------|------------------------------|
| Supply Voltage (V_{CC}) | 7V |
| All Other Inputs | -0.3V to ($V_{CC} + 0.3V$) |
| Operating Temperature Range | 0°C to 70°C |
| Junction Temperature | 125°C |
| Storage Temperature Range | -65°C to 150°C |
| Lead Temperature (Soldering, 10 sec) | 300°C |

PACKAGE/ORDER INFORMATION

| | |
|--|-------------------|
| | ORDER PART NUMBER |
| | LTC1695CS5 |
| | S5 PART MARKING |
| | LTIY |

Consult factory for Industrial and Military grade parts.

ELECTRICAL CHARACTERISTICS The ● denotes the specifications which apply over the full operating temperature range, otherwise specifications are at $T_A = 25^\circ\text{C}$. $V_{CC} = 5V$ unless otherwise stated.

| SYMBOL | PARAMETER | CONDITIONS | MIN | TYP | MAX | UNITS |
|----------|---------------------------|---|-----|-------|-----|---------------|
| V_{CC} | Supply Voltage Range | | 4.5 | 5 | 5.5 | V |
| I_{CC} | Supply Current, Operating | $V_{OUT} = \text{Full Scale}$, $I_{LOAD} = 150\text{mA}$ | ● | 150.7 | 155 | mA |
| | Supply Current, Shutdown | DAC Code = 0 | ● | 80 | 200 | μA |

DAC

| | | | | | | | |
|-------------|----------------------------|----------------------------------|---|------|------------|----------|----|
| | DAC Resolution | Guaranteed Monotonic | ● | 6 | | Bits | |
| V_{LSB} | 1LSB Resolution | $I_{LOAD} = 1\text{mA}$ | ● | 73 | 78 | 83 | mV |
| V_{OS} | Offset Error | $I_{LOAD} = 1\text{mA}$ | ● | | ± 1 | LSB | |
| DNL | Differential Nonlinearity | $I_{LOAD} = 1\text{mA}$ (Note 2) | ● | | ± 0.75 | LSB | |
| INL | Integral Nonlinearity | $I_{LOAD} = 1\text{mA}$ (Note 2) | ● | | ± 0.75 | LSB | |
| V_{FS} | V_{OUT} , DAC Full Scale | $I_{LOAD} = 20\text{mA}$ | ● | 4.5 | 4.93 | V | |
| | | $I_{LOAD} = 150\text{mA}$ | ● | 4.5 | 4.9 | V | |
| V_{ZS} | V_{OUT} , DAC Zero Scale | $R_{LOAD} = 1\text{k}\Omega$ | ● | 0 | 85 | mV | |
| $R_{ON(P)}$ | P-Channel On Resistance | $I_{LOAD} = 150\text{mA}$ | | 0.75 | | Ω | |

Timer and Thermal Shutdown

| | | | | | | | |
|---------------|--------------------------------|--|---|-----|-----|------------------|----|
| V_{UVLO} | Undervoltage Lockout Voltage | Rising V_{CC} | ● | 2.3 | 2.9 | 3.5 | V |
| T_{BST_ST} | Boost Start Timer | $I_{LOAD} = 10\text{mA}$, $C_{LOAD} = 4.7\mu\text{F}$ | ● | 75 | 250 | 1000 | ms |
| $T_{THERMAL}$ | Thermal Shutdown Temperature | (Note 3) | | 155 | | $^\circ\text{C}$ | |
| I_{FAULT} | Output Current Limit Threshold | $V_{OUT} = 0V$, DAC Code = 63 | ● | 180 | 390 | 850 | mA |

SMBus SCL, SDA Inputs

| | | | | | | |
|-----------|---|--|---|-----------|---------|---------------|
| V_{IH} | Input High Threshold | | ● | 2.1 | | V |
| V_{IL} | Input Low Threshold | | ● | | 0.8 | V |
| I_{IN} | Input Current | SCL, SDA = 0V or 5V | ● | ± 0.1 | ± 5 | μA |
| C_{IN} | Input Capacitance | (Note 3) | | 3 | | pF |
| t_{ON} | Switch On Time from Stop Condition ($f_{SMBUS} = 100\text{kHz}$) | V_{OUT} from Zero Scale to Full Scale, $I_{LOAD} = 1\text{mA}$, $C_{LOAD} = 4.7\mu\text{F}$ | ● | 50 | 500 | μs |
| t_{OFF} | Switch Off Time from Stop Condition ($f_{SMBUS} = 100\text{kHz}$) | V_{OUT} from Full Scale to Zero Scale, $I_{LOAD} = 150\text{mA}$, $C_{LOAD} = 4.7\mu\text{F}$ | ● | 150 | 500 | μs |
| V_{OL} | SDA Output Low Voltage | $I_{PULLUP} = 3\text{mA}$ | ● | 150 | 400 | mV |

ELECTRICAL CHARACTERISTICS

The ● denotes the specifications which apply over the full operating temperature range, otherwise specifications are at $T_A = 25^\circ\text{C}$. $V_{CC} = 5\text{V}$ unless otherwise stated.

| SYMBOL | PARAMETER | CONDITIONS | MIN | TYP | MAX | UNITS |
|------------------------------|--|------------|-----|-----|------|---------------|
| SMBus TIMING (Note 4) | | | | | | |
| f_{SMB} | SMBus Operating Frequency | | ● | 10 | 100 | kHz |
| t_{BUF} | Bus Free Time Between Stop and Start | | ● | 4.7 | | μs |
| $t_{\text{HD(STA)}}$ | Hold Time After (Repeated) Start Condition | | ● | 4.0 | | μs |
| $t_{\text{SU(STA)}}$ | Repeated Start Condition Setup Time | | ● | 4.7 | | μs |
| $t_{\text{SU(STO)}}$ | Stop Condition Setup Time | | ● | 4.0 | | μs |
| $t_{\text{HD(DAT)}}$ | Data Hold Time | | ● | 300 | | ns |
| $t_{\text{SU(DAT)}}$ | Data Setup Time | | ● | 250 | | ns |
| t_{LOW} | Clock Low Period | | ● | 4.7 | | μs |
| t_{HIGH} | Clock High Period | | ● | 4.0 | 50 | μs |
| t_f | Clock/Data Fall Time | | ● | | 300 | ns |
| t_r | Clock/Data Rise Time | | ● | | 1000 | ns |

Note 1: Absolute Maximum Ratings are those values beyond which the life of a device may be impaired.

Note 2: INL, DNL specs are specified under a 1mA I_{LOAD} condition to keep the linear regulator from operating in dropout at higher DAC codes. DNL is measured from code 0 to code 63, taking into account the untrimmed offset at code 0. Please refer to the Definitions section for more details.

Note 3: This typical specification is based on lab measurements and is not production tested.

Note 4: Guaranteed by design and not tested. Please refer to the Timing Diagram section for additional information.

TYPICAL PERFORMANCE CHARACTERISTICS

Output Voltage vs DAC Code

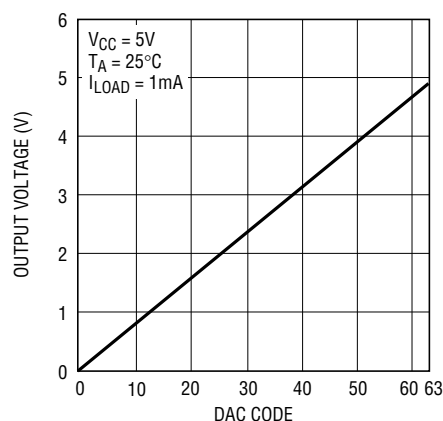

1695 • G01

No Load Supply Current vs Supply Voltage

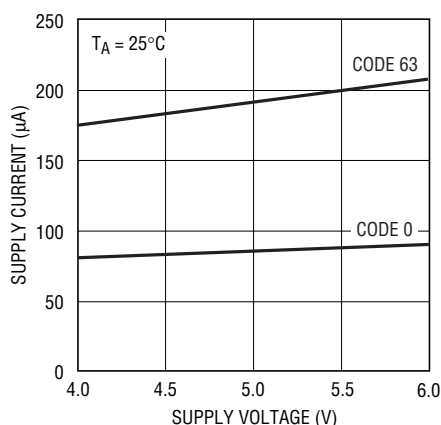

1695 • G02

No Load Supply Current vs Temperature

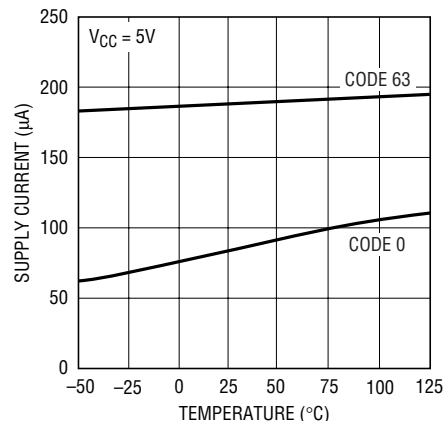

1695 • G03

TYPICAL PERFORMANCE CHARACTERISTICS

Ground Current (Dropout Mode) vs Supply Voltage

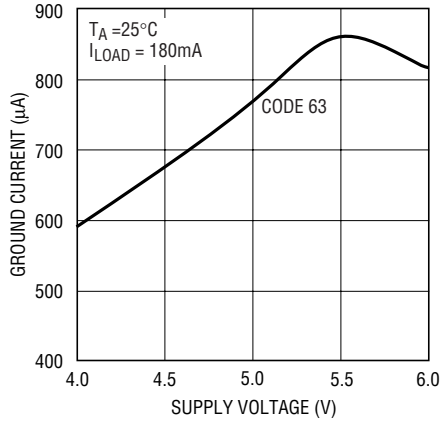

1695 • G04

Ground Current (Dropout Mode) vs Temperature

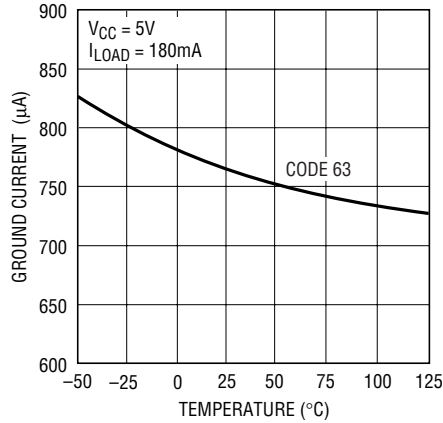

1695 • G05

Dropout Voltage vs Load Current

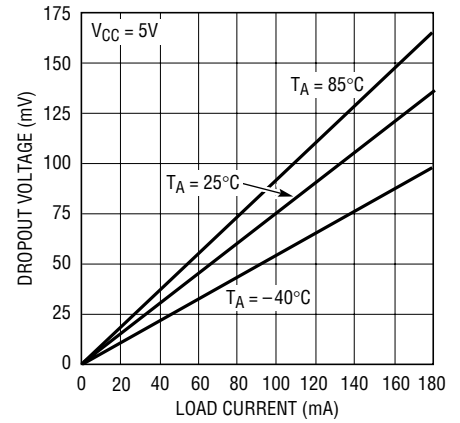

1695 • G06

Output Voltage (Full Scale) vs Load Current

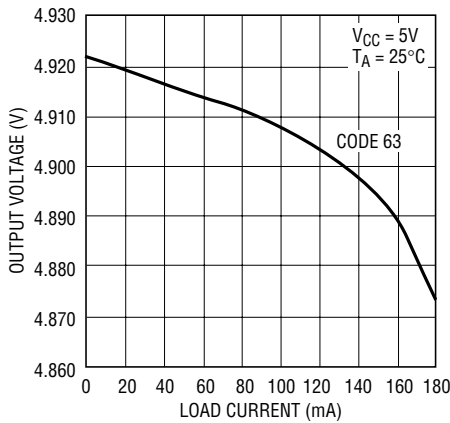

1695 • G07

Output Voltage (Midscale) vs Load Current

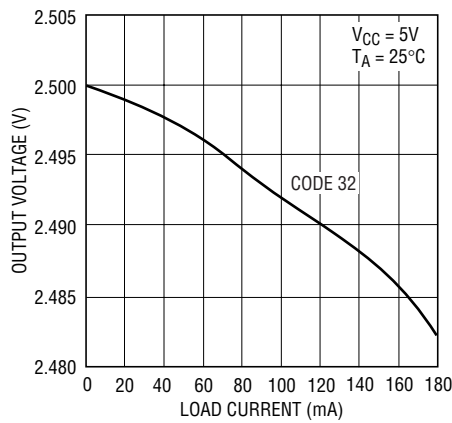

1695 • G08

Output Voltage (Full Scale) vs Temperature

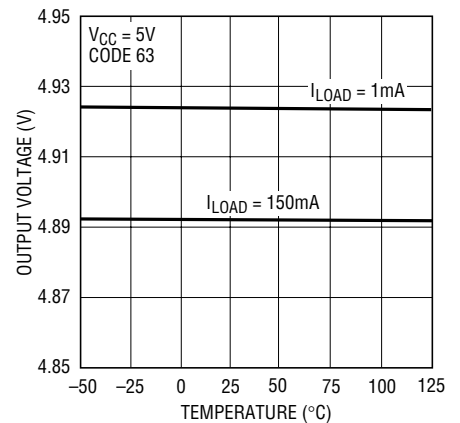

1695 • G09

Output Voltage (Midscale) vs Temperature

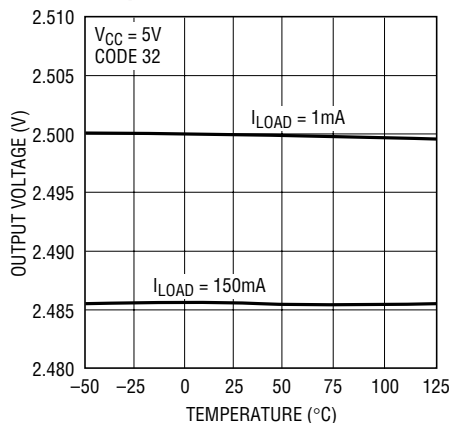

1695 • G10

Differential Nonlinearity (DNL)

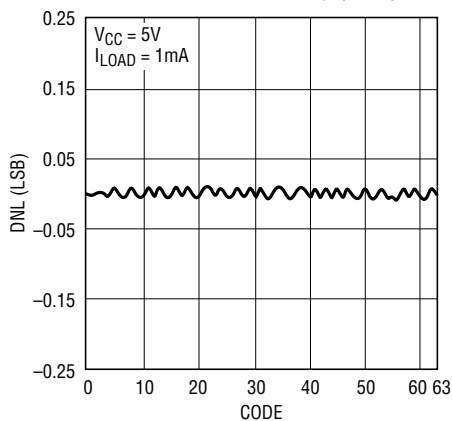

1695 • G11

Integral Nonlinearity (INL)

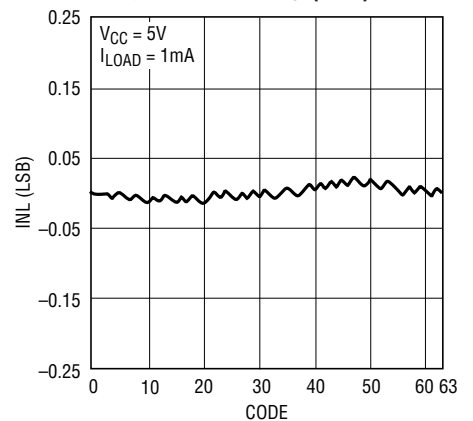

1695 • G12

TYPICAL PERFORMANCE CHARACTERISTICS

POR and UVLO vs Temperature

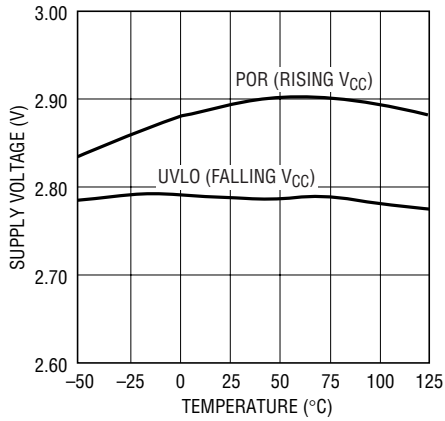

1695 • G13

Boost Start Timer vs Supply Voltage

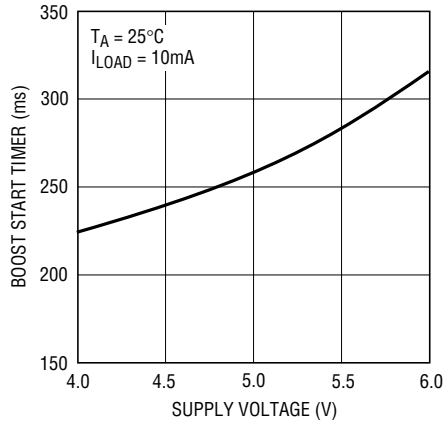

1695 • G14

Boost Start Timer vs Temperature

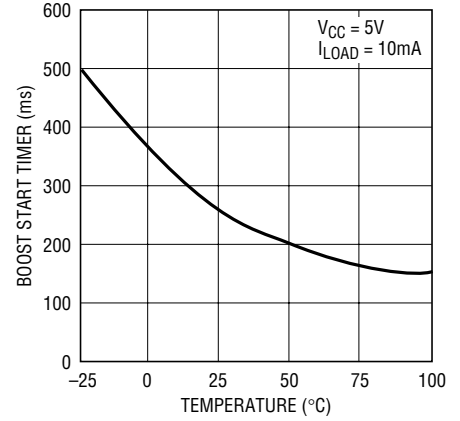

1695 • G15

Current Limit Threshold vs Supply Voltage

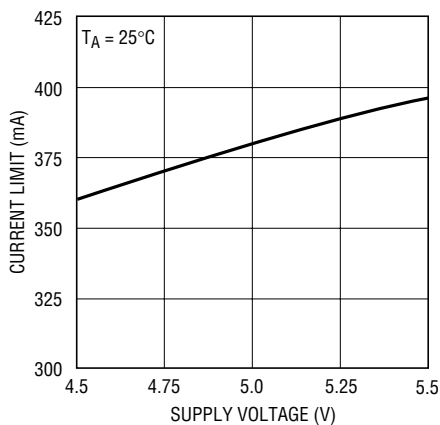

1695 • G16

Current Limit Threshold vs Temperature

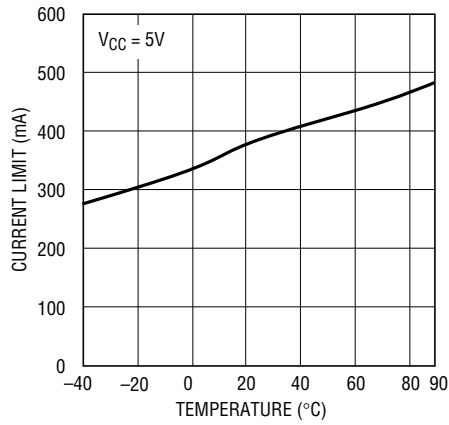

1695 • G17

Junction Temperature Increase vs Load Current

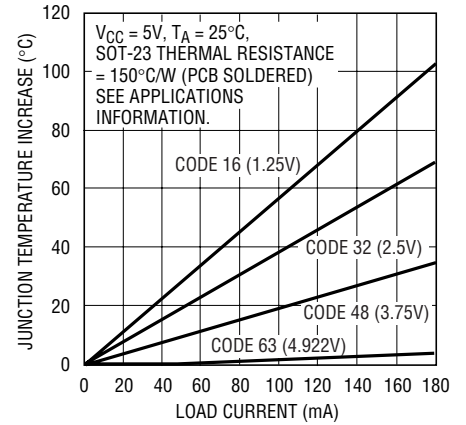

1695 • G18

Load Transient Response Code 32, 5mA to 55mA

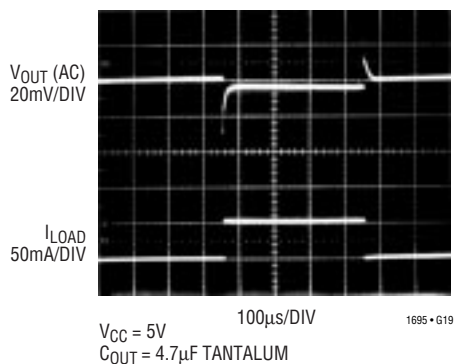

1695 • G19

Load Transient Response Code 32, 50mA to 100mA

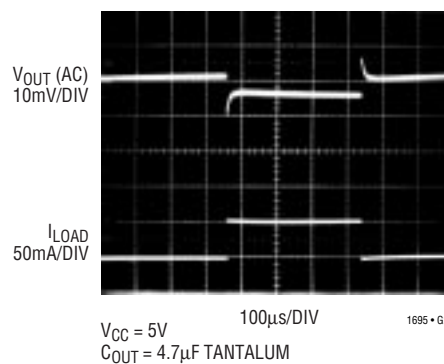

1695 • G20

TYPICAL PERFORMANCE CHARACTERISTICS

**Load Transient Response
Dropout (Code 63), 5mA to 55mA**

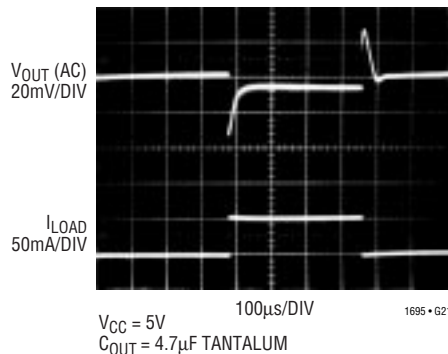

**Load Transient Response
Dropout (Code 63), 50mA to 100mA**

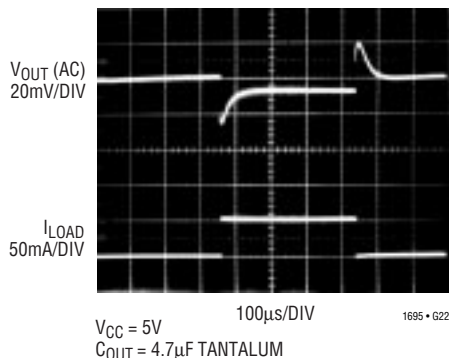

Boost Start Timer

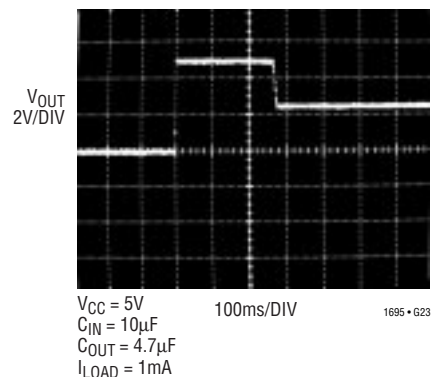

PIN FUNCTIONS

V_{CC} (Pin 1): Power Supply Input. V_{CC} supplies current to the internal control circuitry, serves as the reference for the 6-bit DAC and acts as the power path for the P-channel low dropout linear regulator. Bypass V_{CC} directly to ground with a low ESR capacitor $\geq 10\mu F$.

GND (Pin 2): Ground. Tie GND to the ground plane.

SCL (Pin 3): SMBus Clock Input. Data is shifted into SDA on the rising edge of the SCL clock signal during data transfer.

SDA (Pin 4): SMBus Bidirectional Data Input/Digital Output. SDA is an open drain output and requires a pull-up resistor or current source to V_{CC} . Data is shifted into SDA and acknowledged by SDA.

V_{OUT} (Pin 5): Linear Regulator Output. Connect directly to the fan's $+V_E$ terminal. V_{OUT} is set to V_{ZS} (code 0) on power-up. For good transient response and stability, use a general purpose, low cost, medium ESR (0.1Ω to 1Ω) tantalum or electrolytic capacitor. LTC recommends a surface mount tantalum capacitor of $\geq 4.7\mu F$.

BLOCK DIAGRAM

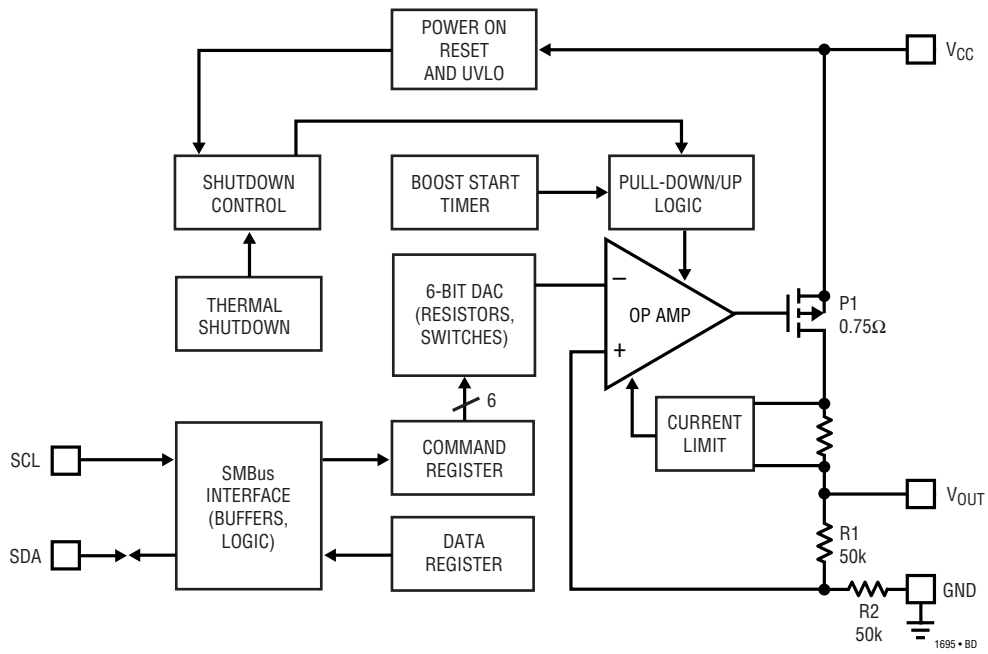

SWITCHING WAVEFORMS

Boost Start Timer Measurement
 $I_{LOAD} = 10mA, C_{LOAD} = 4.7\mu F$

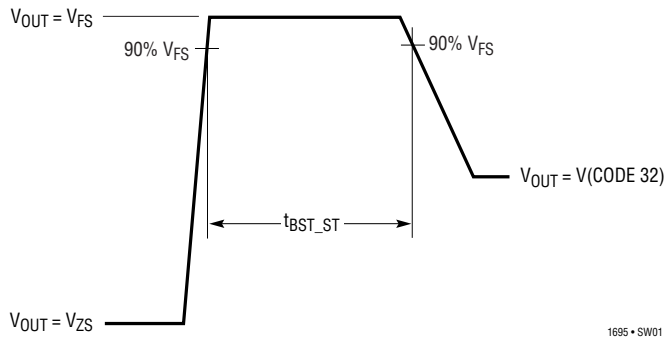

1695 • SW01

Output Switch On Time Measurement
 Code = 63, $I_{LOAD} = 1mA, C_{LOAD} = 4.7\mu F$
 $f_{SMBus} = 100kHz$

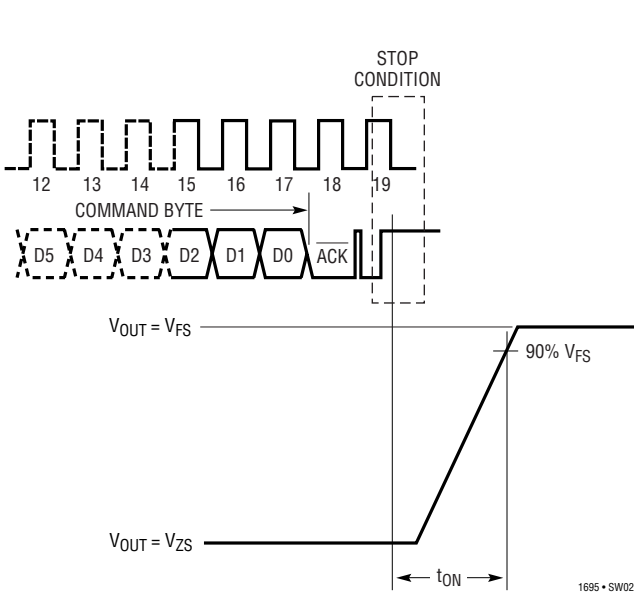

1695 • SW02

Output Switch Off Time Measurement
 Code = 0, $I_{LOAD} = 150mA, C_{LOAD} = 4.7\mu F$
 $f_{SMBus} = 100kHz$

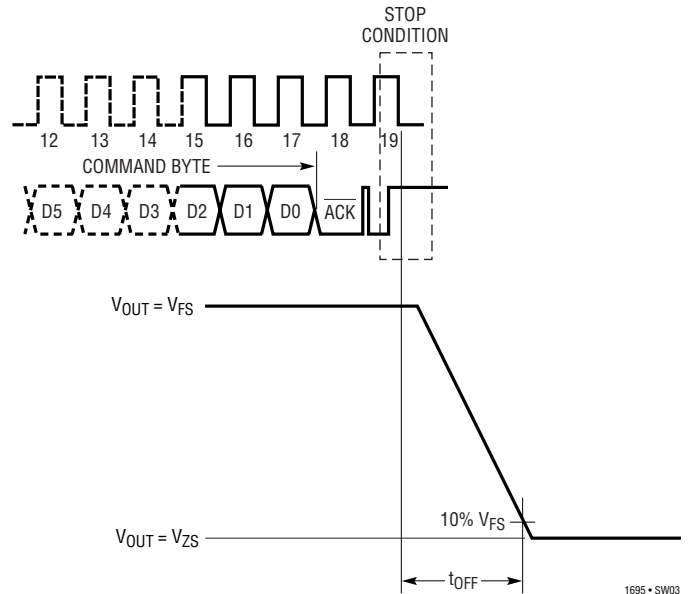

1695 • SW03

TIMING DIAGRAM

Operating Sequence

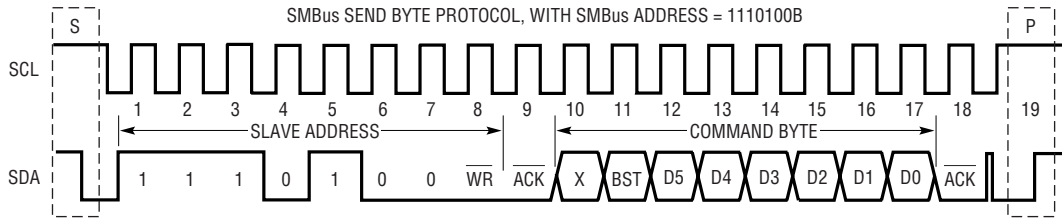

S = SMBus START BIT
 P = SMBus STOP BIT
 BST = 1 ENABLES THE BOOST START TIMER
 D5 TO D0 = 6-BIT INPUT CODE FOR THE DAC (D5 = MSB)
 X = DON'T CARE

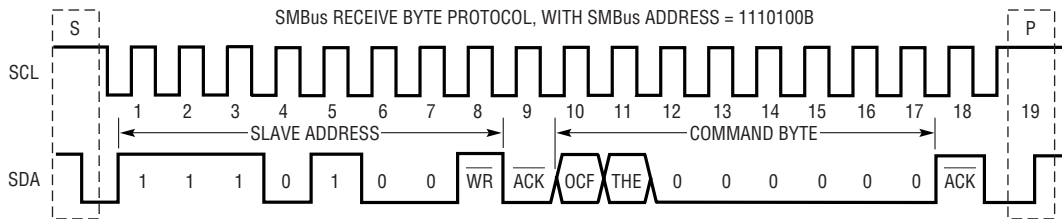

S = SMBus START BIT
 P = SMBus STOP BIT
 OCF = 1 SIGNALS THAT THE LTC1695 IS IN CURRENT LIMIT
 THE = 1 SIGNALS THAT THE LTC1695 IS IN THERMAL SHUTDOWN

1695 • TD01

Timing for SMBus Interface

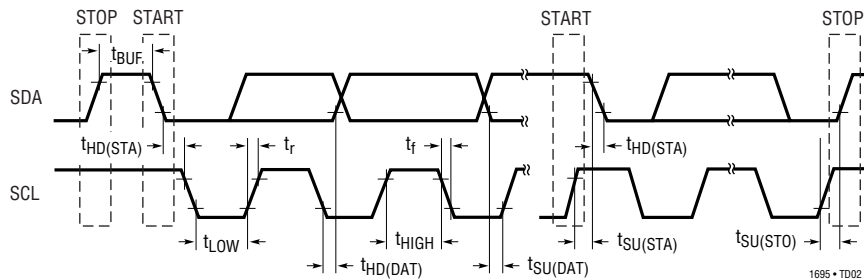

1695 • TD02

DEFINITIONS

Resolution: The number of DAC output states (2^N) that divide the full-scale range. The resolution does not imply linearity.

Full-Scale Voltage (V_{FS}): The regulator output voltage (V_{OUT}) if all DAC bits are set to ones (code 63).

Voltage Offset Error (V_{OS}): The regulator output voltage if all DAC bits are set to zeros. The LDO amplifier can have a true negative offset, but due to the LTC1695's single supply operation, V_{OUT} cannot go below ground. If the offset is negative, V_{OUT} will remain near 0V resulting in the transfer curve shown in Figure 1.

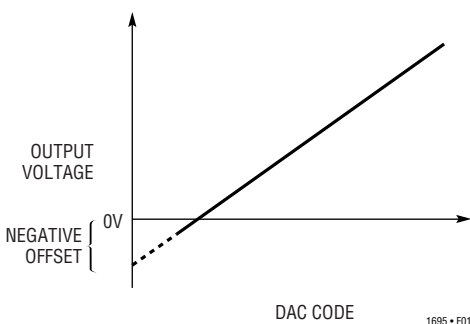

Figure 1. Effect of Negative Offset

The offset of the part is measured at the first code (code 1) that produces an output voltage 0.5LSB greater than the previous code.

$$V_{OS} = V_{OUT} - [(Code \cdot V_{FS}) / (2^N - 1)]$$

Least Significant Bit (V_{LSB}): The least significant bit or the ideal voltage difference between two successive codes.

$$V_{LSB} = (V_{FS} - V_{OS}) / (2^N - 1)$$

Table 1. Nominal V_{LSB} and V_{FS} values

| V_{CC} | V_{LSB} | V_{FS} |
|----------|-----------|----------|
| 4.5V | 70.3mV | 4.430V |
| 5.0V | 78.1mV | 4.922V |
| 5.5V | 85.9mV | 5.414V |

INL: Integral nonlinearity is the maximum deviation from a straight line passing through the endpoints of the DAC transfer curve. Due to the LTC1695's single supply operation and the fact that V_{OUT} cannot go below ground, linearity is measured between full scale and the first code (code 01) that guarantees a positive output. The INL error at a given input code is calculated as follows:

$$INL = (V_{OUT} - V_{IDEAL}) / V_{LSB}$$

$$V_{IDEAL} = (Code \cdot V_{LSB}) + V_{OS}$$

V_{OUT} = The output voltage of the DAC measured at the given input code

DNL: Differential nonlinearity is the difference between the measured change and the ideal 1LSB change between any two adjacent codes. The DNL error between any two codes is calculated as below:

$$DNL = (\Delta V_{OUT} - V_{LSB}) / V_{LSB}$$

ΔV_{OUT} = The measured voltage difference between two adjacent codes

The ΔV_{OUT} calculation includes the V_{OS} values to account for the effect of negative offset in Figure 1. This is relevant for code 1's DNL.

APPLICATIONS INFORMATION

OVERVIEW

The LTC1695 is a 5V brushless DC fan speed controller. Fan speed is controlled by linearly regulating the applied voltage to the fan. To program fan speed, a system controller or microprocessor first sends a 6-bit digital code to the LTC1695 via a 2-wire SMBus/I²C interface. The LTC1695's DAC then converts this digital code into a voltage reference. Finally, the LTC1695's op amp loop regulates the gate bias of the internal P-channel pass transistor to control the corresponding output voltage.

The LTC1695 is designed for portable, power-conscious systems that utilize small 5V brushless DC fans. These fans are increasingly popular in providing efficient cooling solutions in a small footprint. Smaller fans allow a user to employ multiple fans at strategic physical locations to govern a system's thermal airflow ("air duct" concept). These brushless DC fans also make use of the 5V supply used by the main digital/analog circuitry, removing the need for a 12V supply required by higher power fans.

The LTC1695's P-channel linear regulator control approach offers the lowest solution component count, the smallest PCB board space consumed, wide fan speed control range and low acoustical/electrical generated noise. Thermal concerns over the use of a linear regulator topology are eliminated by the fan's generally resistive behavior. As the LTC1695 DAC codes are changed to lower the output voltage, the voltage across the internal P-channel pass transistor increases. However, the fan's load current decreases almost linearly, thereby controlling power dissipation in the regulator. For example, a Micronel 5V, 0.7W fan (40mm² • 12mm) draws 80mA at 4V and 20mA at 2V. Thus the P-channel pass transistor's power loss decreases from 80mW to 60mW.

The LTC1695 incorporates several features to simplify the overall solution including a boost start timer to ensure fan start-up, output current limiting and thermal shutdown. The boost start timer is enabled via the SMBus commands

and programs V_{OUT} to full scale for 250ms before regulating at the user programmed output voltage. This eliminates potential fan start-up problems at lower output voltage DAC codes.

The LTC1695's thermal shutdown circuit trips if die temperature exceeds 155°C. The P-channel pass transistor is shut off and bit D6 in the LTC1695's SMBus data register is set high. If an overload or short-circuit condition occurs, the LTC1695's current-limit circuitry limits output current to 390mA typically. In addition, bit D7 in the SMBus data register is set high. The readback capability of the LTC1695 allows the host controller to monitor the status of the D6 and D7 bits for fault conditions.

SMBus Serial Interface

The LTC1695 is an SMBus slave device that supports both SMBus send byte and receive byte protocol (Figure 2) with two interface signals, SCL and SDA.

The SMBus host initiates communication with the LTC1695 through a start bit followed by a 7-bit address code and a write bit. Each SMBus slave device in the system compares the address code with its specific address. For send byte and receive byte protocol, the write bit is LOW and HIGH respectively. If selected, the LTC1695 acknowledges by pulling SDA low.

If send byte protocol is used, the host issues an 8-bit command code. After receiving the entire command byte, the LTC1695 again acknowledges by pulling SDA low. At the falling edge of the acknowledge pulse, the LTC1695's DAC latches in the new command byte from its shift register.

If receive byte protocol is used, the LTC1695 acknowledges by pulling SDA low after the write bit. The LTC1695 then transmits the data byte. After the host receives the entire data byte, the cycle is terminated by a "NOT Acknowledge" bit and a stop bit.

APPLICATIONS INFORMATION

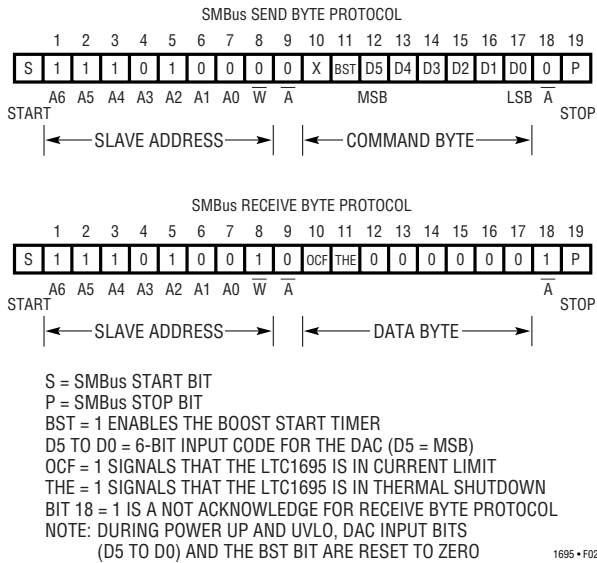

Figure 2. SMBus Interface Bit Definition

SCL and SDA

SCL is the synchronizing clock signal generated by the host. SDA is the bidirectional data transfer line between the host and a slave device. The host initiates a start bit by pulling SDA from high to low while SCL is high. The stop bit is initiated by changing SDA from low to high while SCL is high. All address, command and acknowledge signals must be valid and should not change while SCL is high. The acknowledge bit signals to the host the acceptance of a correct address byte or command byte.

The SCL and SDA input threshold voltages are typically 1.4V with 40mV of hysteresis. Connect the SCL and SDA open-drain lines to either a resistive or current source pull up. The LTC1695 SDA has an open-drain N-channel tran-

sistor capable of sinking 3mA at less than 0.4V during the slave acknowledge sequence.

The LTC1695 is compatible with the Philips/Sigmetics I²C Bus Interface. The 1.4V threshold for SCL and SDA does not create any I²C application problems.

Early Stop Conditions

If a stop condition occurs before the data byte is acknowledged in the write byte protocol, the LTC1695's DAC is not updated. Otherwise, the internal register is updated with the new data and V_{OUT} changes accordingly to the new programmed value.

Address, Command, Data Selection

The LTC1695's address is hard-wired internally as 1110100 (MSB to LSB, A6 to A0). Consult LTC for parts with alternate address codes. Consult the Address, Command and Data Byte Tables for further information and as a concise reference.

As shown in Figure 2, D5 to D0 in the command code, control the linear regulator's output voltage and thus fan speed. D5 to D0 are sent from the host to the LTC1695 during send byte protocol. The LTC1695 latches D5 to D0 as DAC input data at the falling edge of the data acknowledge signal. The host must set "BST" (boost start enable bit) to high if the LTC1695's 250ms boost start timer option is used. All bits are reset to zero during power-on reset and UVLO. As shown in the Timing Diagram, bit 6 and bit 7 in the data byte register are defined as thermal shutdown status (THE) and over current fault (OCF) status respectively. The LTC1695 sets OCF high if I_{LOAD} exceeds 390mA typically and "THE" high if junction temperature exceeds 155°C typically. The remaining bits of the data byte's register (bit 5 to 0) are set low during host read back.

APPLICATIONS INFORMATION

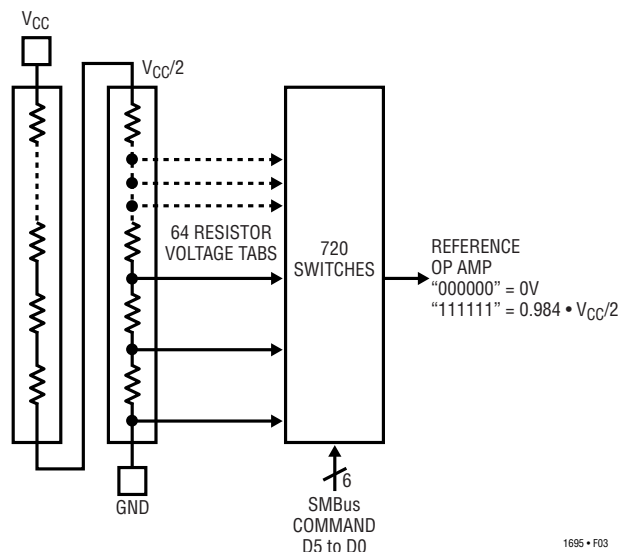

Figure 3. Ladder DAC

DAC

The LTC1695 uses a 128-segment resistor ladder to implement the monotonic 6-bit voltage DAC (Figure 3). Guaranteeing monotonicity (no missing codes) permits the use of the LTC1695 in thermal feedback control applications. As the typical application uses a 5V supply for V_{CC} , the reference for the 6-bit DAC is V_{CC} . LTC recommends a $10\mu\text{F}$ or greater tantalum capacitor to bypass V_{CC} . Users must account for the variation in the DAC's output absolute accuracy as V_{CC} varies. V_{CC} voltage should not exceed the absolute maximum rating of 7V or drop below the typical 2.8V undervoltage lockout threshold (UVLO) during normal operation.

The LTC1695's DAC specifications (INL, DNL, V_{OS}) account for the offset and gain errors of the linear regulator with respect to I_{LOAD} . Consult the Definitions section for more details.

The worst-case condition occurs if the LTC1695 P-channel pass transistor enters dropout at full-scale V_{OUT} and I_{LOAD} . Full-scale V_{OUT} (V_{FS}) is 4.922V with $V_{CC} = 5\text{V}$. In this condition, loop gain drops and gain error increases. The LTC1695 is designed for monotonicity up to V_{FS} with DNL and INL less than 0.75 LSB. Refer to the Electrical Characteristics and Typical Performance Characteristics for more information.

Linear Regulator Loop Compensation

The LTC1695's linear regulator approach is a simple and practical scheme for fan speed control featuring a wide and linear dynamic range. It also introduces less noise into the system supply rail, compared with a PWM scheme (fixed frequency, variable duty cycle), switching regulator topology or simple ON-OFF control.

The LTC1695 linear regulator feedback loop requires a capacitor at its output to stabilize the loop over the output voltage and load current range. The output capacitor value and the capacitor's ESR value are critical in stabilizing the LTC1695 feedback loop.

A $\geq 1\mu\text{F}$ general purpose, low to medium ESR (0.1Ω to 5Ω) tantalum or aluminium electrolytic capacitor is sufficient for most applications. These capacitor types offer a low-cost advantage, particularly for fan speed control applications. As the output capacitance value increases, stability improves. A typical $4.7\mu\text{F}$, 1Ω ESR surface mount tantalum capacitor is recommended for the optimum transient response and frequency stability across temperature, V_{OUT} and I_{LOAD} . Refer to the load transient response waveforms in the Typical Performance Characteristics section.

The selection of the capacitor for C_{OUT} must be evaluated by the user for temperature variation of the capacitance and ESR value and the voltage coefficient of the capacitor value. For example, the ESR of aluminium electrolytic capacitors can increase dramatically at cold temperature. Therefore, the regulator may be stable at room temperature but oscillate at cold temperature. Ceramic capacitors with Z5U and Y5 dielectrics provide high capacitance values in a small package, but exhibit strong voltage and temperature coefficients (-80% in some cases). In addition, the ESR of surface mount ceramic capacitors is too low ($<0.1\Omega$) to provide adequate phase-lead in the feedback loop for stability.

Fan Load and C_{LOAD}

Referring to Figure 4, C_{LOAD} varies greatly depending on the type of fan used. The simplest, inexpensive fans contain no protection circuitry and input capacitance is on the order of 200pF . More expensive fans generally incorporate a series-diode for reverse protection and input

APPLICATIONS INFORMATION

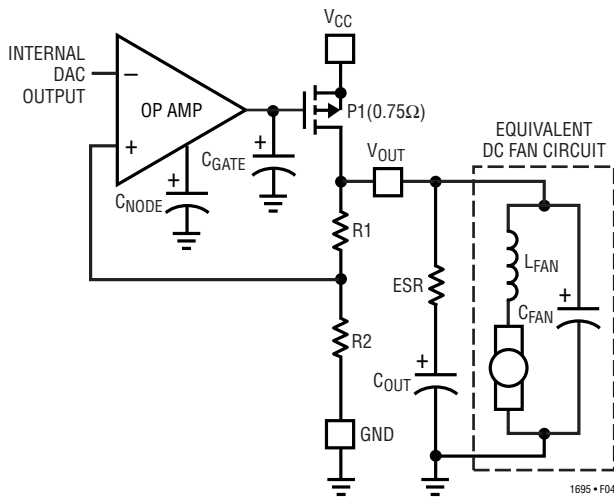

Figure 4. Regulator Feedback Loop

capacitance ranges from 2pF to 30pF. As previously discussed, an output bypass capacitor is required to stabilize the feedback loop. This output capacitor is in parallel with the fan's input capacitance and dominates the total capacitance. Thus, stability is generally not affected by the fan's input capacitance. The output capacitor also serves to filter the fan's output ripple during commutation of the fan's motor.

POR and UVLO

Under start-up conditions, the LTC1695 performs a power on reset (POR) function. The digital logic circuitry is disabled and the regulator is held off. The SMBus command register (to the DAC's input) and data register (current limit and thermal shutdown status) are reset to zero. The POR signal deactivates if V_{CC} rises above 2.9V typically. The LTC1695 is then allowed to communicate with the SMBus host and drive the fan accordingly. Upon exiting POR, the regulator's output voltage is set to V_{ZS} (code 0) until programmed by the SMBus host.

The LTC1695 enters UVLO if V_{CC} falls below 2.8V typically. Between 2.8V and 1V, the digital logic circuitry is disabled, the command/data registers are cleared and the regulator is shut down. In general, 100mV of hysteresis exists between the UVLO and POR thresholds.

Thermal Considerations

The LTC1695's power handling capability is limited by the maximum rated junction temperature of 125°C. Power dissipation (P_{DISS}) consists of two components:

1. Output current multiplied by the input/output voltage differential: $(I_{LOAD})(V_{CC} - V_{OUT})$, and
2. GND pin current multiplied by the input voltage: $(I_{GND})(V_{CC})$.

$$P_{DISS} = (I_{LOAD})(V_{CC} - V_{OUT}) + (I_{GND})(V_{CC})$$

$$T_J = P_{DISS} \cdot (\theta_{JA})$$

The LTC1695 has active current limiting and thermal shutdown circuitry for device protection during overload or fault condition. For continuous overload conditions, do not exceed the 125°C maximum junction temperature $T_{J(MAX)}$. Give careful consideration to all thermal resistance sources from junction to ambient. Consider any additional heat sources mounted in proximity to the LTC1695. This is particularly relevant in applications where the LTC1695's output is loaded with a constant I_{LOAD} and V_{OUT} is dynamically varied via the SMBus. At lower DAC output voltage codes, the increased input-to-output differential increases power dissipation if I_{LOAD} does not decrease.

For the LTC1695's 5-lead SOT-23 surface mount package, heat sinking is accomplished by using the heat spreading capabilities of the PC board and its copper traces (in particular, the GND pin trace).

The following table lists measured thermal resistance results for various size boards and copper areas. All measurements were taken in still air on 3/32" FR-4 board with one ounce copper.

Table 2. Measured Thermal Resistance (θ_{JA})

| Copper Area | | Board Area | Thermal Resistance (Junction to Ambient) |
|---------------------|---------------------|---------------------|--|
| Topside* | Backside | | |
| 2500mm ² | 2500mm ² | 2500mm ² | 125°C/W |
| 1000mm ² | 2500mm ² | 2500mm ² | 125°C/W |
| 225mm ² | 2500mm ² | 2500mm ² | 130°C/W |
| 100mm ² | 2500mm ² | 2500mm ² | 135°C/W |
| 50mm ² | 2500mm ² | 2500mm ² | 150°C/W |

*Device is mounted on topside

APPLICATIONS INFORMATION

For further information, refer to the Junction Temperature Increase (above ambient temperature) vs I_{LOAD} graph in the Typical Performance Characteristics section. This graph provides a fast and simple junction temperature estimation with various V_{OUT} (DAC code) and I_{LOAD} combinations for a typical application.

Boost Start Timer

In general, a 5V brushless DC fan starts at a voltage value higher than the voltage at which it stalls. This behavior is directly attributed to the force necessary to overcome the back EMF of the fan. For example, one fan measured started at 3.5V but operated until its terminal voltage fell below 2.1V. Therefore, users must ensure start-up in the fan before programming the fan voltage to a value lower than the starting voltage. Monitoring the fan's DC current for a stalled condition does not work due to the fan's resistive nature. Fans can sink load current even though they are not rotating. Other approaches include detecting absence of the fan's commutation ripple current and tachometers. In general, these approaches are more complex, require more circuitry, add cost and have to be customized for the specific fan used.

The LTC1695 contains a programmable boost start timer offering three flexible solutions to the user:

- 1.) Enable the boost start timer bit (D6 in the DAC command code). Each time a new output voltage is programmed, the timer forces V_{OUT} to full scale (4.922V nominal with $V_{CC} = 5V$) for 250ms before assuming the programmed output voltage value. This ensures fan start up even if the programmed output voltage is below the fan's start threshold.
- 2.) Users may also choose to use a software timer routine inside the host controller to power the DC fan, at full scale, for a programmed time period before programming V_{OUT} to a lower desired DAC output voltage code.
- 3.) Users may choose a tachometer fan that feedbacks its speed to the SMBus host. If fan stall conditions are detected, the SMBus host re-programs the LTC1695.

Beyond a typical 125°C LTC1695 junction temperature, the boost start timer (if activated) maintains V_{OUT} at full

scale (V_{FS}) until junction temperature decreases to approximately 105°C. This extended timer period is an attempt to cool down the system and the LTC1695 by running the fan at full speed. In most cases, such elevated ambient temperatures require the fan to run at full speed anyway. The remaining LTC1695's functionality remains unchanged.

Thermal Shutdown, Overcurrent

The LTC1695 shuts down the P-channel linear regulator if die temperature exceeds 155°C typically. The thermal shutdown circuitry employs about 30°C of hysteresis. As previously mentioned, the LTC1695 sets bit 6 (THE) in the SMBus data byte register HIGH during thermal shutdown conditions. During a fault condition, the LTC1695's SMBus logic continues to operate so that the SMBus host can read back the fault status data.

During an overload or short-circuit fault condition, the LTC1695's current-limit detector sets bit 7 (OCF) in the SMBus data byte register HIGH and actively limits output current to 390mA typically. This protects the LTC1695's P-channel pass transistor. Under dead short conditions with $V_{OUT} = 0V$, the LTC1695 also clamps the output current. However, the increased power dissipation ($5V \cdot 390mA = 1.95W$) eventually forces the LTC1695 into thermal shutdown. The LTC1695 will then thermally oscillate until the fault condition is removed.

During recovery from thermal shutdown (typically 125°C), the LTC1695 automatically activates the boost start timer, programming the fan voltage to full scale for 250ms (T_{BST_ST}), before switching to the user programmed output voltage value. This again eliminates fan start-up problems if the thermal shutdown fault occurred while the fan was previously operating at an output voltage below the fan's starting voltage. In addition, as discussed, the boost start timer will keep V_{OUT} at V_{FS} for an extended time period beyond T_{BST_ST} until the LTC1695's junction temperature drops below 105°C.

The LTC1695's protection features protect itself, the fan, and more importantly alerts the SMBus host to any system thermal management fault conditions.

APPLICATIONS INFORMATION

DC FAN SELECTION

The LTC1695, in the 5-lead SOT-23 package, caters mainly to 5V brushless DC fans, in spot cooling and notebook computer applications, that consume less than 1W maximum. These applications typically require fan footprints on the order of 4000mm³ to 20000mm³. Such fan sizes are common and commercially available. Examples of these miniature fans are the “Ultra-thin DC fan” and “Extra-mini DC fan” from SUNON Inc. Models in these series range from 17mm to 40mm in size, weigh from 4 grams to 10 grams and provides airflow densities from 0.65 CFM to 6 CFM.

Users must consider parameters like physical size (L • W • H), airflow (CFM), power dissipation (W) and acoustically generated noise (dBA) when choosing a fan. Users must also evaluate the fan’s I-V characteristics versus fan speed and the start/stall characteristics of the fan. Other factors include mechanical considerations such as low cost sleeve bearings or ball bearings that have better long term reliability. Finally, users must consider if the fan requires any input protection features such as reverse-voltage protection. All of these factors affect the fan’s cost.

Table 3 lists some 5V fan manufacturer’s contact information.

Table 3. 5V DC Fan Manufacturers

| Manufacturer | Address |
|-----------------------------|--|
| SUNON Inc. | 1075 W. Lambert Rd., Brea, CA 92821 Tel: (714)255-0208 Website: http://www.sunon.com |
| Advanced Technology Company | 1280 Liberty Way, Vista, CA 92083 Tel: (760)727-7430 |
| Nidec America | 152 Will Dr., Canton, MA 02021 Tel: (781)828-6216 Website: http://nidec.com |
| NMB Technologies Inc. | 9730 Independence Ave., Chatsworth, CA 91311 Tel: (818)341-3355 Website: http://www.nmbtech.com |
| Micronel | 1280 Liberty Way, Vista, CA 92083 Tel: (760)727-7400 Website: http://www.micronel.com |

Table 4 lists some 5V brushless DC fans suitable for typical LTC1695 fan speed control applications. Figure 5 shows the measured I-V characteristics of these fans. For a particular fan selection, users must determine the minimum DAC output voltage code below which the fan stalls. Most fans continue to consume current, even in a stalled condition.

Table 4. Some 5V DC Fans’ Characteristics

| Manufacturer | Part Number | Airflow (CFM) | Power (W) | Size (L • W • H)mm ³ |
|--------------|---------------|---------------|-----------|---------------------------------|
| SUNON | KDE0501PFB2-8 | 0.65 | 0.50 | 20 • 20 • 10 |
| ATC | AD0205HB-G51 | 0.80 | 0.45 | 25 • 25 • 10 |
| SUNON | KDE0502PFB2-8 | 1.70 | 0.60 | 25 • 25 • 10 |
| SUNON | KDE0503PFB2-8 | 3.20 | 0.60 | 30 • 30 • 10 |
| SUNON | KDE0535PFB2-8 | 4.80 | 0.70 | 35 • 35 • 10 |
| Micronel | F41MM-005XK-9 | 6.10 | 0.70 | 40 • 40 • 12 |

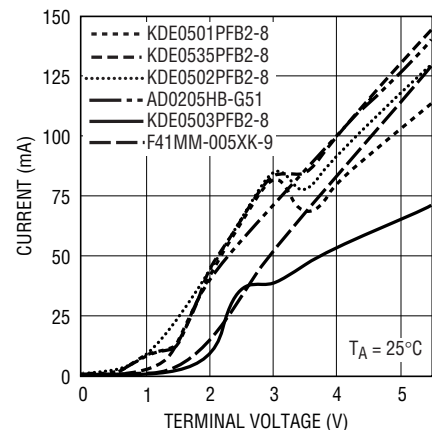

Figure 5. I-V Characteristics of 5V Brushless DC Fan Samples

APPLICATIONS INFORMATION

SMBus Address Byte Table

| Decimal | HEX | SMBus Protocol |
|---------|-----|-------------------------------|
| 232 | E8 | Send Byte to the LTC1695 |
| 233 | E9 | Receive Byte from the LTC1695 |

The LSB of the SMBus address is the write bit. For send byte protocol, W = 0. For Receive byte protocol, W = 1

SMBus Command Byte Table (Send Byte Protocol)

| DECIMAL (D5 to D0) | BINARY MSB LSB | HEX (D6-D7 set to 0) | Nominal $V_{OUT}(V)$ $I_{LOAD} = 1mA$ |
|-----------------------|----------------------|-------------------------|--|
| 0 | X0000000 | 00 | 0.000 |
| 1 | X0000001 | 01 | 0.078 |
| 2 | X0000010 | 02 | 0.156 |
| 3 | X0000011 | 03 | 0.234 |
| 4 | X0000100 | 04 | 0.313 |
| 5 | X0000101 | 05 | 0.391 |
| 6 | X0000110 | 06 | 0.469 |
| 7 | X0000111 | 07 | 0.547 |
| 8 | X0001000 | 08 | 0.625 |
| 9 | X0001001 | 09 | 0.703 |
| 10 | X0001010 | 0A | 0.781 |
| 11 | X0001011 | 0B | 0.859 |
| 12 | X0001100 | 0C | 0.938 |
| 13 | X0001101 | 0D | 1.016 |
| 14 | X0001110 | 0E | 1.094 |
| 15 | X0001111 | 0F | 1.172 |
| 16 | X0010000 | 10 | 1.250 |
| 17 | X0010001 | 11 | 1.328 |
| 18 | X0010010 | 12 | 1.406 |
| 19 | X0010011 | 13 | 1.484 |
| 20 | X0010100 | 14 | 1.563 |
| 21 | X0010101 | 15 | 1.641 |
| 22 | X0010110 | 16 | 1.719 |
| 23 | X0010111 | 17 | 1.797 |
| 24 | X0011000 | 18 | 1.875 |
| 25 | X0011001 | 19 | 1.953 |
| 26 | X0011010 | 1A | 2.031 |
| 27 | X0011011 | 1B | 2.109 |
| 28 | X0011100 | 1C | 2.188 |
| 29 | X0011101 | 1D | 2.266 |
| 30 | X0011110 | 1E | 2.344 |
| 31 | X0011111 | 1F | 2.422 |

D6 = 0 disables the boost start timer.
D7 = X = don't care

SMBus Data Byte Table (Receive Byte Protocol)

| DECIMAL | BINARY MSB LSB | HEX | LTC1695 Status |
|---------|----------------------|-----|-------------------------|
| 0 | 00000000 | 00 | No Fault |
| 128 | 10000000 | 80 | Overcurrent Fault/Clamp |
| 64 | 01000000 | 40 | Thermal Shutdown |

During thermal shutdown, the LTC1695's LDO is shut off.

| DECIMAL (D5 to D0) | BINARY MSB LSB | HEX (D6-D7 set to 0) | Nominal $V_{OUT}(V)$ $I_{LOAD} = 1mA$ |
|-----------------------|----------------------|-------------------------|--|
| 32 | X0100000 | 20 | 2.500 |
| 33 | X0100001 | 21 | 2.578 |
| 34 | X0100010 | 22 | 2.656 |
| 35 | X0100011 | 23 | 2.734 |
| 36 | X0100100 | 24 | 2.813 |
| 37 | X0100101 | 25 | 2.891 |
| 38 | X0100110 | 26 | 2.969 |
| 39 | X0100111 | 27 | 3.047 |
| 40 | X0101000 | 28 | 3.125 |
| 41 | X0101001 | 29 | 3.203 |
| 42 | X0101010 | 2A | 3.281 |
| 43 | X0101011 | 2B | 3.359 |
| 44 | X0101100 | 2C | 3.438 |
| 45 | X0101101 | 2D | 3.516 |
| 46 | X0101110 | 2E | 3.594 |
| 47 | X0101111 | 2F | 3.672 |
| 48 | X0110000 | 30 | 3.750 |
| 49 | X0110001 | 31 | 3.828 |
| 50 | X0110010 | 32 | 3.906 |
| 51 | X0110011 | 33 | 3.984 |
| 52 | X0110100 | 34 | 4.063 |
| 53 | X0110101 | 35 | 4.141 |
| 54 | X0110110 | 36 | 4.219 |
| 55 | X0110111 | 37 | 4.297 |
| 56 | X0111000 | 38 | 4.375 |
| 57 | X0111001 | 39 | 4.453 |
| 58 | X0111010 | 3A | 4.531 |
| 59 | X0111011 | 3B | 4.609 |
| 60 | X0111100 | 3C | 4.688 |
| 61 | X0111101 | 3D | 4.766 |
| 62 | X0111110 | 3E | 4.844 |
| 63 | X0111111 | 3F | 4.922 |

D6 = 0 disables the boost start timer.
D7 = X = don't care

APPLICATIONS INFORMATION

SMBus Command Byte Table (Boost Start Timer Enabled)

| DECIMAL (D5 to D0) | BINARY MSB LSB | HEX (D7 set to 0) | Nominal $V_{OUT}(V)$ $I_{LOAD} = 1mA$ |
|-----------------------|----------------------|----------------------|--|
| 0 | X1000000 | 40 | 0.000 |
| 1 | X1000001 | 41 | 0.078 |
| 2 | X1000010 | 42 | 0.156 |
| 3 | X1000011 | 43 | 0.234 |
| 4 | X1000100 | 44 | 0.313 |
| 5 | X1000101 | 45 | 0.391 |
| 6 | X1000110 | 46 | 0.469 |
| 7 | X1000111 | 47 | 0.547 |
| 8 | X1001000 | 48 | 0.625 |
| 9 | X1001001 | 49 | 0.703 |
| 10 | X1001010 | 4A | 0.781 |
| 11 | X1001011 | 4B | 0.859 |
| 12 | X1001100 | 4C | 0.938 |
| 13 | X1001101 | 4D | 1.016 |
| 14 | X1001110 | 4E | 1.094 |
| 15 | X1001111 | 4F | 1.172 |
| 16 | X1010000 | 50 | 1.250 |
| 17 | X1010001 | 51 | 1.328 |
| 18 | X1010010 | 52 | 1.406 |
| 19 | X1010011 | 53 | 1.484 |
| 20 | X1010100 | 54 | 1.563 |
| 21 | X1010101 | 55 | 1.641 |
| 22 | X1010110 | 56 | 1.719 |
| 23 | X1010111 | 57 | 1.797 |
| 24 | X1011000 | 58 | 1.875 |
| 25 | X1011001 | 59 | 1.953 |
| 26 | X1011010 | 5A | 2.031 |
| 27 | X1011011 | 5B | 2.109 |
| 28 | X1011100 | 5C | 2.188 |
| 29 | X1011101 | 5D | 2.266 |
| 30 | X1011110 | 5E | 2.344 |
| 31 | X1011111 | 5F | 2.422 |

D6 = 1 enables the boost start timer.
D7 = X = don't care

| DECIMAL (D5 to D0) | BINARY MSB LSB | HEX (D7 set to 0) | Nominal $V_{OUT}(V)$ $I_{LOAD} = 1mA$ |
|-----------------------|----------------------|----------------------|--|
| 32 | X1100000 | 60 | 2.500 |
| 33 | X1100001 | 61 | 2.578 |
| 34 | X1100010 | 62 | 2.656 |
| 35 | X1100011 | 63 | 2.734 |
| 36 | X1100100 | 64 | 2.813 |
| 37 | X1100101 | 65 | 2.891 |
| 38 | X1100110 | 66 | 2.969 |
| 39 | X1100111 | 67 | 3.047 |
| 40 | X1101000 | 68 | 3.125 |
| 41 | X1101001 | 69 | 3.203 |
| 42 | X1101010 | 6A | 3.281 |
| 43 | X1101011 | 6B | 3.359 |
| 44 | X1101100 | 6C | 3.438 |
| 45 | X1101101 | 6D | 3.516 |
| 46 | X1101110 | 6E | 3.594 |
| 47 | X1101111 | 6F | 3.672 |
| 48 | X1110000 | 70 | 3.750 |
| 49 | X1110001 | 71 | 3.828 |
| 50 | X1110010 | 72 | 3.906 |
| 51 | X1110011 | 73 | 3.984 |
| 52 | X1110100 | 74 | 4.063 |
| 53 | X1110101 | 75 | 4.141 |
| 54 | X1110110 | 76 | 4.219 |
| 55 | X1110111 | 77 | 4.297 |
| 56 | X1111000 | 78 | 4.375 |
| 57 | X1111001 | 79 | 4.453 |
| 58 | X1111010 | 7A | 4.531 |
| 59 | X1111011 | 7B | 4.609 |
| 60 | X1111100 | 7C | 4.688 |
| 61 | X1111101 | 7D | 4.766 |
| 62 | X1111110 | 7E | 4.844 |
| 63 | X1111111 | 7F | 4.922 |

D6 = 1 enables the boost start timer.
D7 = X = don't care

PACKAGE DESCRIPTION

Dimensions in inches (millimeters) unless otherwise noted.

S5 Package
5-Lead Plastic SOT-23
 (LTC DWG # 05-08-1633)

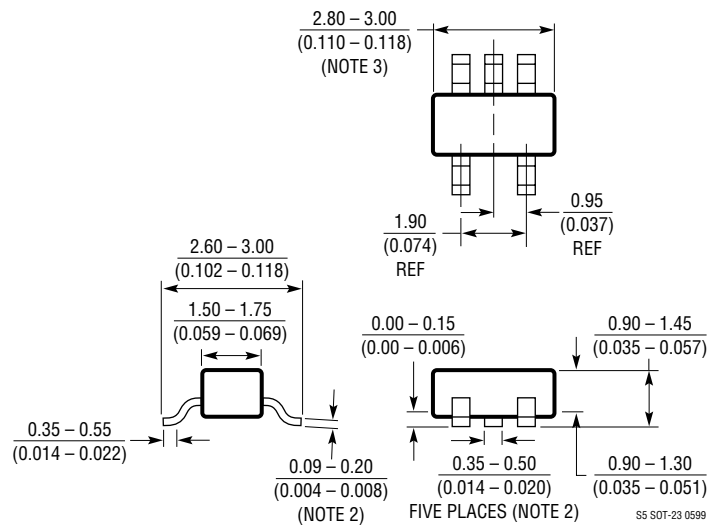
**NOTE:**

1. DIMENSIONS ARE IN MILLIMETERS
2. DIMENSIONS ARE INCLUSIVE OF PLATING
3. DIMENSIONS ARE EXCLUSIVE OF MOLD FLASH AND METAL BURR
4. MOLD FLASH SHALL NOT EXCEED 0.254mm
5. PACKAGE EIAJ REFERENCE IS SC-74A (EIAJ)

TYPICAL APPLICATION

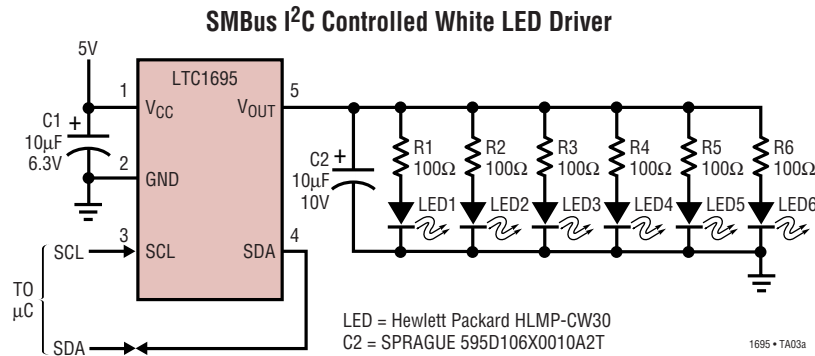

Output Voltage vs LED Current

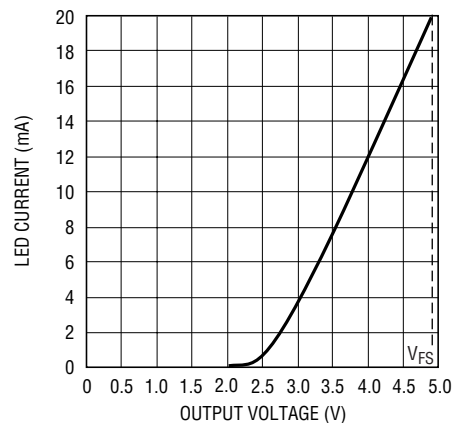

RELATED PARTS

| PART NUMBER | DESCRIPTION | COMMENTS |
|-------------------|---|---|
| LT1120 | 125mA Low Dropout PNP Linear Regulator with 40µA Quiescent Current | 0.6V Dropout Voltage at 125mA |
| LT1121 | 150mA Low Dropout PNP Linear Regulator with 30µA Quiescent Current | 0.5V Dropout Voltage at 150mA, S08/SOT-223 package |
| LTC1380/LTC1393 | Single-Ended 8-Channel/Differential 4-Channel Analog Mux with SMBus Interface | Low R _{ON} : 35Ω Single-Ended/70Ω Differential, Expandable to 32 Single or 16 Differential Channels |
| LTC1427-50 | Micropower, 10-Bit Current Output DAC with SMBus Interface | Precision 50µA ± 2.5% Tolerance Over Temperature, 4 Selectable SMBus Addresses, DAC Powers up at Zero or Midscale |
| LT1521 | 300mA Low Dropout PNP Linear Regulator with 12µA Quiescent Current | 0.5V Dropout Voltage at 150mA, S08/SOT-223 Package |
| LTC1623 | Dual High Side Switch Controller with SMBus Interface | 8 Selectable Addresses/16-Channel Capability |
| LTC1663 | SMBus Interface 10-Bit Rail-to-Rail Micropower DAC | DNL < 0.75LBS Max, 5-Lead SOT-23 Package |
| LTC1694/LTC1694-1 | SMBus Accelerator | Improved SMBus/I ² C Rise Time, Ensures Data Integrity with Multiple SMBus/I ² C Devices |
| LT1761 | 100mA, Low Noise, LDO Micropower Regulator | 0.3V Dropout Voltage at 100mA, SOT-23 Package |
| LT1762 | 150mA, Low Noise, LDO Micropower Regulator | 0.3V Dropout Voltage at 150mA, MSOP Package |
| LT1786F | SMBus Controlled CCFL Switching Regulator | 1.25A, 200kHz, Floating or Grounded Lamp Configurations |