

Dual Adjustable 5-Bit VID High Efficiency, 2-Phase Current Mode Synchronous Buck DC/DC Controller

FEATURES

- **Out-of-Phase Controllers Reduce Input Capacitance and Power Supply Induced Noise**
- **OPTI-LOOP® Compensation Minimizes C_{OUT}**
- **Power Good Output Monitors Both Outputs**
- **5-Bit Mobile VID Control, V_{OUT}: 0.9V to 2.0V**
- **Dual N-Channel MOSFET Synchronous Drive**
- **±1% Output Voltage Accuracy**
- **DC Programmed Fixed Frequency 150kHz to 300kHz**
- **Wide V_{IN} Range: 3.5V to 36V Operation**
- **Very Low Dropout Operation: 99% Duty Cycle**
- **Adjustable Soft-Start Current Ramping**
- **Foldback Output Current Limiting**
- **Latched Short-Circuit Shutdown with Defeat Option**
- **Output Overvoltage Protection**
- **Remote Output Voltage Sense**
- **Low Shutdown Current: 20µA**
- **5V and 3.3V Standby Regulators**
- **Selectable Constant Frequency, Burst Mode® and Continuous Operation**

APPLICATIONS

- Notebook and Palmtop Computers, PDAs
- Portable Instruments

DESCRIPTION

The LTC[®]1708 is a dual adjustable 5-bit VID programmable step-down switching regulator controller that drives all N-Channel power MOSFET stages. A constant frequency current mode architecture allows adjustment of the frequency up to 300kHz. Power loss and noise due to the ESR of the input capacitance are minimized by operating the two main controller output stages out of phase.

OPTI-LOOP compensation allows the transient response to be optimized over a wide range of output capacitance and ESR values. The precision 0.8V reference is compatible with future microprocessor generations, and a wide 3.5V to 30V (36V maximum) input supply range that encompasses all battery chemistries. A power good output indicates when the output voltages are within 7.5% of their programmed value.

A RUN/SS pin for each controller provides both soft-start and an optional timed, short-circuit shutdown. Other protection features include: internal foldback current limiting and an output overvoltage crowbar. The forced continuous control pin (FCB) can be used to inhibit Burst Mode operation or to regulate a third, flyback output.

LT, LTC and LT are registered trademarks of Linear Technology Corporation.
 Burst Mode and OPTI-LOOP are registered trademarks of Linear Technology Corporation.

TYPICAL APPLICATION

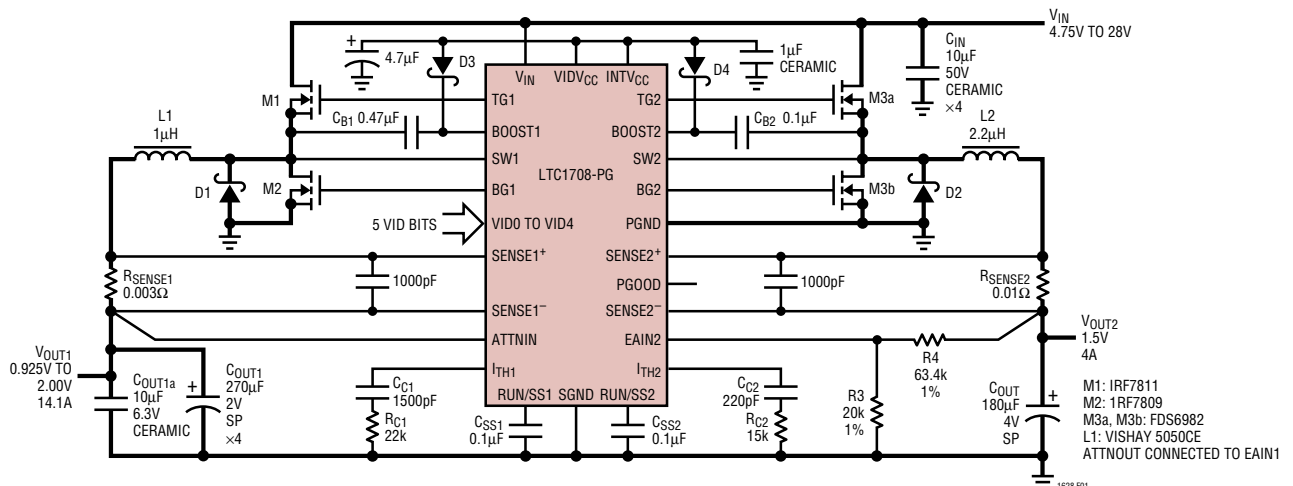

Figure 1. High Efficiency VID Controlled, 2-Output Step-Down Converter

ABSOLUTE MAXIMUM RATINGS

(Note 1)

| | |
|---|----------------------------------|
| Input Supply Voltage (V_{IN}) | 36V to -0.3V |
| Topside Driver Voltages (BOOST1, BOOST2) | 42V to -0.3V |
| Switch Voltage (SW1, SW2) | 36V to -5V |
| INTV _{CC} , EXT _{CC} , RUN/SS1, RUN/SS2, (BOOST1-SW1), (BOOST2-SW2), | 7V to -0.3V |
| SENSE1 ⁺ , SENSE2 ⁺ , SENSE1 ⁻ , SENSE2 ⁻ Voltages | (1.1)INTV _{CC} to -0.3V |
| FREQSET, STBYMD, FCB, VIDV _{CC} , VID0-4, PGOOD Voltages | 7V to -0.3V |
| I _{TH1} , I _{TH2} , EAIN1, EAIN2, ATTNIN, ATTNOUT Voltages | 2.7V to -0.3V |
| Peak Output Current <10 μ s (TG1, TG2, BG1, BG2) ... | 3A |
| INTV _{CC} Peak Output Current | 50mA |
| Operating Ambient Temperature Range (Note 2) | -40°C to 85°C |
| Junction Temperature (Note 3) | 125°C |
| Storage Temperature Range | -65°C to 150°C |
| Lead Temperature (Soldering, 10 sec) | 300°C |

PACKAGE/ORDER INFORMATION

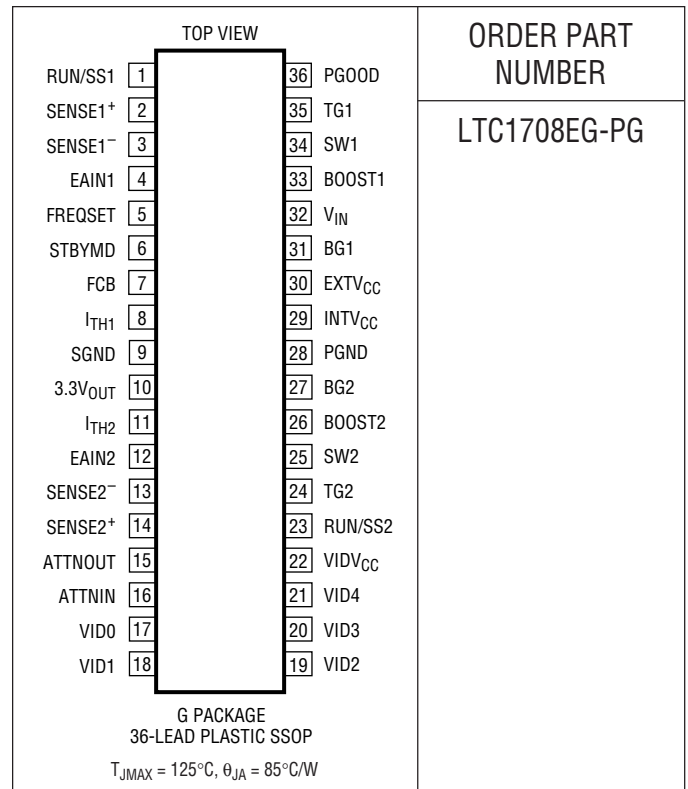

ORDER PART NUMBER

LTC1708EG-PG

Consult LTC Marketing for parts specified with wider operating temperature ranges.

ELECTRICAL CHARACTERISTICS

The ● denotes the specifications which apply over the full operating temperature range, otherwise specifications are at $T_A = 25^\circ\text{C}$. $V_{IN} = 15\text{V}$, $V_{RUN/SS1, 2} = 5\text{V}$ unless otherwise noted.

| SYMBOL | PARAMETER | CONDITIONS | MIN | TYP | MAX | UNITS |
|---------------------------|--|--|---------|------------------|-------------|-------------------------------|
| Main Control Loops | | | | | | |
| $V_{EAIN1, 2}$ | Regulated Feedback Voltage at EAIN Pin | (Note 4); I _{TH1, 2} Voltage = 1.2V | ● 0.792 | 0.800 | 0.808 | V |
| $I_{EAIN1, 2}$ | Feedback Current | (Note 4) | | -5 | -50 | nA |
| $V_{REFLNREG}$ | Reference Voltage Line Regulation | $V_{IN} = 3.6\text{V}$ to 30V (Note 4) | | 0.002 | 0.02 | %/V |
| $V_{LOADREG}$ | Output Voltage Load Regulation | (Note 4) Measured in Servo Loop; I _{TH1, 2} Voltage = 1.2V to 0.7V Measured in Servo Loop; I _{TH1, 2} Voltage = 1.2V to 2.0V | ● ● | 0.1 -0.1 | 0.5 -0.5 | % % |
| $g_{m1, 2}$ | Transconductance Amplifier g_m | I _{TH1, 2} = 1.2V; Sink/Source 5 μ A; (Note 4) | | 1.3 | | mmho |
| $g_{mOL1, 2}$ | Transconductance Amplifier GBW | I _{TH1, 2} = 1.2V; ($g_m \cdot Z_L$, No Ext Load) (Note 4) | | 3 | | MHz |
| I_Q | Input DC Supply Current | (Note 5) EXTV _{CC} Tied to GND; VID Inputs Open Circuit Normal Mode Standby Shutdown | | 850 125 20 | | μ A μ A μ A |
| V_{FCB} | Forced Continuous Threshold | | ● 0.760 | 0.800 | 0.840 | V |
| I_{FCB} | Forced Continuous Current | $V_{FCB} = 0.85\text{V}$ | | -0.3 | -0.18 | -0.1 μ A |
| $V_{BINHIBIT}$ | Burst Inhibit Threshold | Measured at FCB pin | | 4.3 | 4.8 | V |
| UVLO | Undervoltage Lockout | V_{IN} Ramping Down | | 3.5 | 4 | V |

1708f

ELECTRICAL CHARACTERISTICS

The ● denotes the specifications which apply over the full operating temperature range, otherwise specifications are at $T_A = 25^\circ\text{C}$. $V_{IN} = 15\text{V}$, $V_{RUN/SS1, 2} = 5\text{V}$ unless otherwise noted.

| SYMBOL | PARAMETER | CONDITIONS | MIN | TYP | MAX | UNITS |
|---|--|---|----------|-------------|----------|---------------|
| V_{OV} | Output Overvoltage Threshold | Measured at EAIN1, 2 | 0.84 | 0.86 | 0.88 | V |
| I_{SENSE} | Sense Pins Total Source Current | (Each Channel); $V_{SENSE1-, 2-} = V_{SENSE1+, 2+} = 0\text{V}$ | -85 | -60 | | μA |
| $V_{STBYMD MS}$ | Master Shutdown Threshold | V_{STBYMD} Ramping Down | 0.4 | 0.6 | | V |
| $V_{STBYMD KA}$ | Keep-Alive Power On-Threshold | V_{STBYMD} Ramping Up, $RUN_{SS1, 2} = 0\text{V}$ | | 1.5 | 2 | V |
| DF_{MAX} | Maximum Duty Factor | In Dropout | 98 | 99.4 | | % |
| $I_{RUN/SS1, 2}$ | Soft-Start Charge Current | $V_{RUN/SS1, 2} = 1.9\text{V}$ | 0.5 | 1.2 | | μA |
| $V_{RUN/SS1, 2 ON}$ | RUN/SS Pin ON Threshold | $V_{RUN/SS1, 2}$ Rising | 1.0 | 1.5 | 1.9 | V |
| $V_{RUN/SS1, 2 LT}$ | RUN/SS Pin Latchoff Threshold | $V_{RUN/SS1, 2}$ Rising from 3V | | 4.1 | 4.5 | V |
| $I_{SCL1, 2}$ | RUN/SS Discharge Current | Soft Short Condition $E_{AIN1, 2} = 0.5\text{V}$; $V_{RUN/SS1, 2} = 4.5\text{V}$ | 0.5 | 2 | 4 | μA |
| I_{SDLHO} | Shutdown Latch Disable Current | $E_{AIN1, 2} = 0.5\text{V}$ | | 1.6 | 5 | μA |
| $V_{SENSE(MAX)}$ | Maximum Current Sense Threshold | $V_{EAIN1, 2} = 0.7\text{V}$; $V_{SENSE1, 2} = 5\text{V}$ $V_{EAIN1, 2} = 0.7\text{V}$; $V_{SENSE1, 2} = 5\text{V}$ | 65 62 | 75 75 | 85 88 | mV mV |
| $TG1, 2 t_r$ | TG Transition Time: Rise Time | $C_{LOAD} = 3300\text{pF}$ (Note 10) | | 50 | 90 | ns |
| $TG1, 2 t_f$ | TG Transition Time: Fall Time | $C_{LOAD} = 3300\text{pF}$ (Note 10) | | 50 | 90 | ns |
| $BG1, 2 t_r$ | BG Transition Time: Rise Time | $C_{LOAD} = 3300\text{pF}$ (Note 10) | | 40 | 90 | ns |
| $BG1, 2 t_f$ | BG Transition Time: Fall Time | $C_{LOAD} = 3300\text{pF}$ (Note 10) | | 40 | 80 | ns |
| $TG/BG t_{1D}$ | Top Gate Off to Bottom Gate On Delay Synchronous Switch-On Delay Time | $C_{LOAD} = 3300\text{pF}$ Each Driver (Note 10) | | 90 | | ns |
| $BG/TG t_{2D}$ | Bottom Gate Off to Top Gate On Delay Top Switch-On Delay Time | $C_{LOAD} = 3300\text{pF}$ Each Driver (Note 10) | | 90 | | ns |
| $t_{ON(MIN)}$ | Minimum On-Time | Tested with a Square Wave (Notes 6, 10) | | 160 | 200 | ns |
| INTV_{CC} Linear Regulator | | | | | | |
| V_{INTVCC} | Internal V_{CC} Voltage | $6\text{V} < V_{IN} < 30\text{V}$, $V_{EXTVCC} = 4\text{V}$ | 4.8 | 5.0 | 5.2 | V |
| $V_{LDO INT}$ | INTV _{CC} Load Regulation | $I_{CC} = 0$ to 20mA, $V_{EXTVCC} = 4\text{V}$ | | 0.2 | 1.0 | % |
| $V_{LDO EXT}$ | EXTV _{CC} Voltage Drop | $I_{CC} = 20\text{mA}$, $V_{EXTVCC} = 5\text{V}$ | | 120 | 240 | mV |
| V_{EXTVCC} | EXTV _{CC} Switchover Voltage | $I_{CC} = 20\text{mA}$, EXTV _{CC} Ramping Positive | 4.5 | 4.7 | | V |
| V_{LDOHYS} | EXTV _{CC} Hysteresis | | | 0.2 | | V |
| Oscillator | | | | | | |
| f_{OSC} | Oscillator Frequency | $V_{FREQSET} = \text{Open}$ (Note 7) | 190 | 220 | 250 | kHz |
| f_{LOW} | Lowest Frequency | $V_{FREQSET} = 0\text{V}$ | 120 | 140 | 170 | kHz |
| f_{HIGH} | Highest Frequency | $V_{FREQSET} = 2.4\text{V}$ | 280 | 310 | 350 | kHz |
| $I_{FREQSET}$ | FREQSET Input Current | $V_{FREQSET} = 0\text{V}$ | | -2 | -1 | μA |
| 3.3V Linear Regulator | | | | | | |
| $V_{3.3OUT}$ | 3.3V Regulator Output Voltage | No Load | 3.25 | 3.35 | 3.45 | V |
| $V_{3.3IL}$ | 3.3V Regulator Load Regulation | $I_{3.3} = 0$ to 10mA | | 0.5 | 2 | % |
| $V_{3.3VL}$ | 3.3V Regulator Line Regulation | $6\text{V} < V_{IN} < 30\text{V}$ | | 0.05 | 0.2 | % |
| PGOOD Output | | | | | | |
| V_{PGL} | PGOOD Voltage Low | $I_{PGOOD} = 2\text{mA}$ | | 0.1 | 0.3 | V |
| I_{PGOOD} | PGOOD Leakage Current | $V_{PGOOD} = 5\text{V}$ | | | 1 | μA |
| V_{PG} | PGOOD Trip Level | Relative to the 0.8V Regulated Feedback Voltage $E_{AIN1, 2}$ Ramping Negative from 0.8V $E_{AIN1, 2}$ Ramping Positive from 0.8V | -10 5 | -7.5 7.5 | -5 10 | % % |

ELECTRICAL CHARACTERISTICS

The ● denotes the specifications which apply over the full operating temperature range, otherwise specifications are at $T_A = 25^\circ\text{C}$. $V_{IN} = 15\text{V}$, $V_{RUN/SS1, 2} = 5\text{V}$ unless otherwise noted.

| SYMBOL | PARAMETER | CONDITIONS | MIN | TYP | MAX | UNITS |
|-----------------------|-----------------------------------|--|-------|------|------|------------------|
| VID Parameters | | | | | | |
| $V_{IDV_{CC}}$ | VID Operating Supply Voltage | | 2.7 | | 5.5 | V |
| $I_{VIDV_{CC}}$ | VID Supply Current | $V_{IDV_{CC}} = 3.3\text{V}$ (Note 8) | | 0.01 | 5 | μA |
| $R_{FBOUT1/SENSE1}$ | Resistance Between ATTNIN/ATTNOUT | | | 10 | 5 | $\text{k}\Omega$ |
| R_{RATIO} | Resistor Ratio Accuracy | Programmed from 0.925V to 2.00V | -0.35 | | 0.25 | % |
| $R_{PULL-UP}$ | VID0 to VID4 Pull-Up Resistance | (Note 9) $V_{DIODE} = 0.7\text{V}$ | | 40 | | $\text{k}\Omega$ |
| V_{IDT} | VID Voltage Threshold | | 0.4 | 1.0 | 1.6 | V |
| $I_{VIDLEAK}$ | VID Input Leakage Current | (Note 9) $V_{IDV_{CC}} < V_{IDV_{CC}} < 7\text{V}$ | | 0.1 | 1 | μA |
| $V_{PULL-UP}$ | VID Pull-Up Voltage | $V_{IDV_{CC}} = 3\text{V}$ | 2.5 | 2.8 | 3.1 | V |

Note 1: Absolute Maximum Ratings are those values beyond which the life of a device may be impaired.

Note 2: The LTC1708EG-PG is guaranteed to meet performance specifications from 0°C to 70°C . Specifications over the -40°C to 85°C operating temperature range are assured by design, characterization and correlation with statistical process controls.

Note 3: T_J is calculated from the ambient temperature T_A and power dissipation P_D according to the following formulas:

$$T_J = T_A + (P_D \cdot 85^\circ\text{C/W})$$

Note 4: The LTC1708-PG is tested in a feedback loop that serves $V_{ITH1, 2}$ to a specified voltage and measures the resultant $E_{AIN1, 2}$.

Note 5: The supply current is higher due to the gate charge being delivered at the switching frequency. See Applications Information.

Note 6: The minimum on-time condition corresponds to the on inductor peak-to-peak ripple current $\geq 40\%$ of I_{MAX} (see minimum on-time considerations in the Applications Information section).

Note 7: $V_{FREQSET}$ pin internally tied to 1.19V reference through a large resistance.

Note 8: With all five VID inputs floating (or tied to $V_{IDV_{CC}}$) the $V_{IDV_{CC}}$ current is typically $< 1\mu\text{A}$. However, the $V_{IDV_{CC}}$ current will rise and be approximately equal to the number of grounded VID input pins times $(V_{IDV_{CC}} - 0.6\text{V})/40\text{k}$. (See the Applications Information section.)

Note 9: Each built-in pull-up resistor attached to the VID inputs also has a series diode to allow input voltages higher than the $V_{IDV_{CC}}$ supply without damage or clamping. (See Applications Information section.)

Note 10: Rise and fall times are measured at 20% to 80% levels. Delay and nonoverlap times are measured using 50% levels.

TYPICAL PERFORMANCE CHARACTERISTICS

Efficiency vs Output Current and Mode (Figure 13)

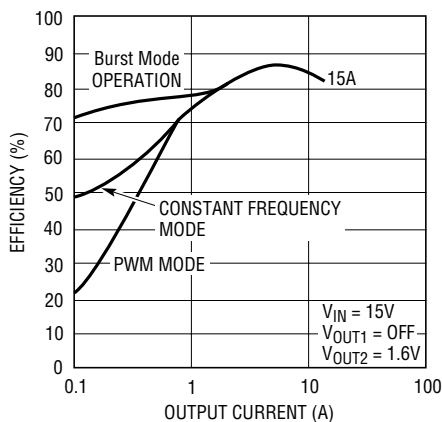

1708 G01

Efficiency vs Output Current (Figure 13)

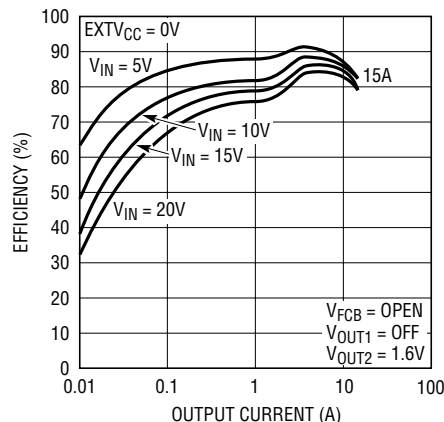

1708 G02

Efficiency vs Input Voltage (Figure 13)

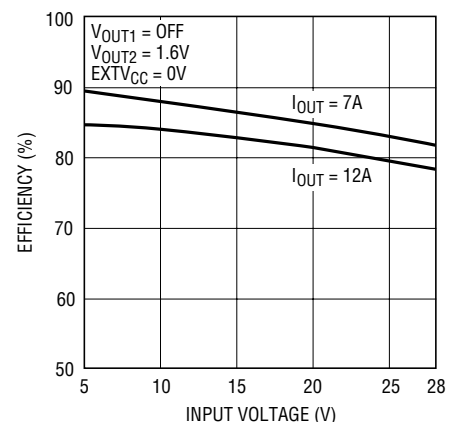

1708 G03

TYPICAL PERFORMANCE CHARACTERISTICS

Supply Current vs Input Voltage and Mode (Figure 13)

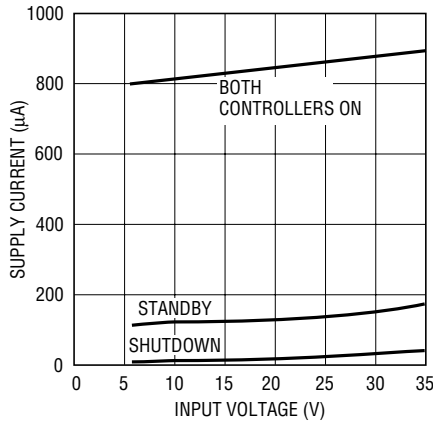

1708 G04

EXTV_{CC} Voltage Drop

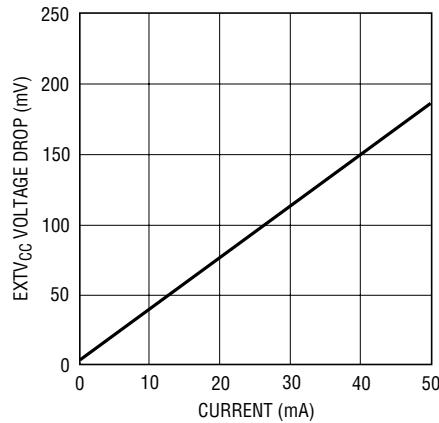

1708 G05

INTV_{CC} and EXTV_{CC} Switch Voltage vs Temperature

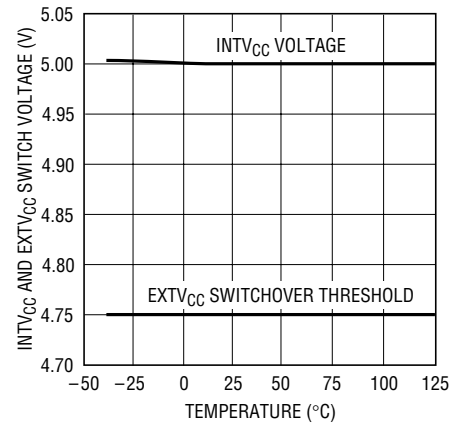

1708 G06

Internal 5V LDO Line Reg

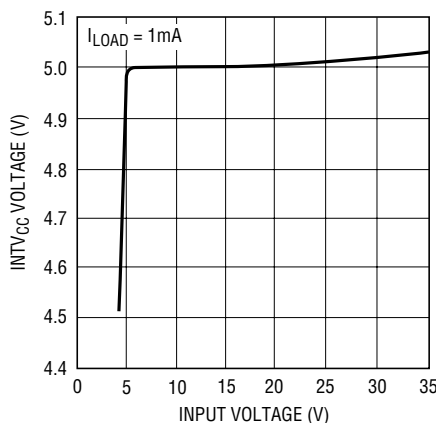

1708 G07

Maximum Current Sense Threshold vs Duty Factor

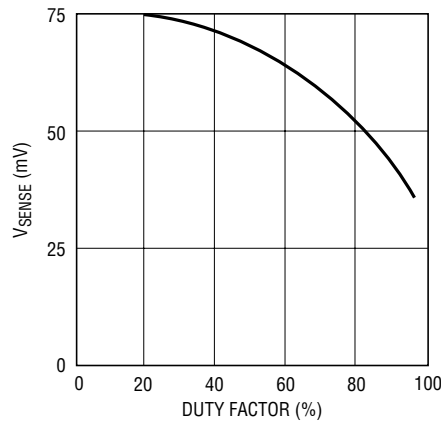

1708 G08

Maximum Current Sense Threshold vs Percent of Nominal Output Voltage (Foldback)

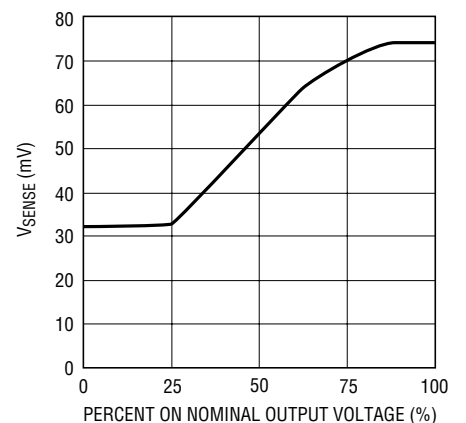

1708 G09

Maximum Current Sense Threshold vs V_{RUN/SS} (Soft-Start)

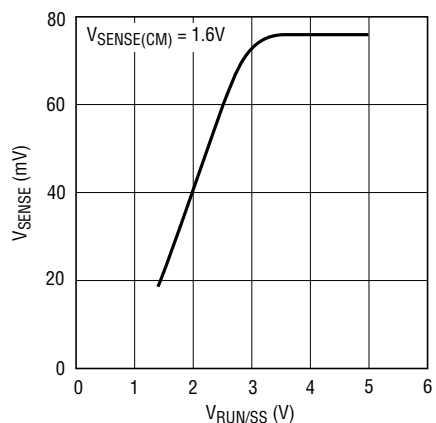

1708 G10

Maximum Current Sense Threshold vs Sense Common Mode Voltage

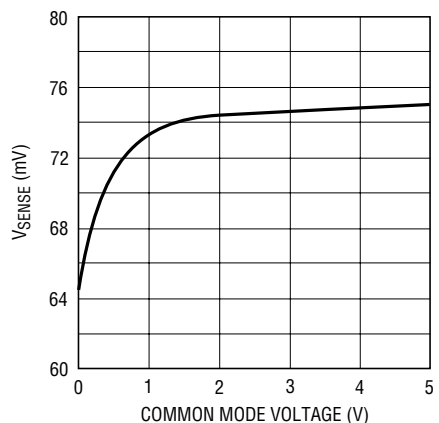

1708 G11

Current Sense Threshold vs I_{TH} Voltage

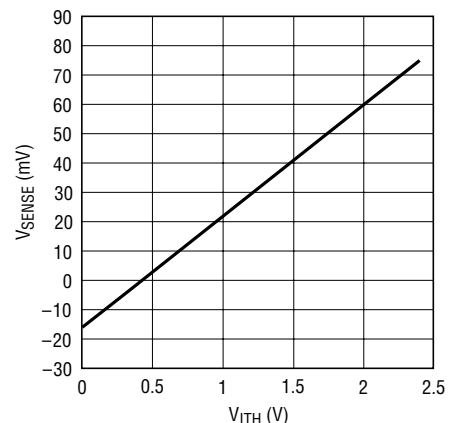

1708 G12

TYPICAL PERFORMANCE CHARACTERISTICS

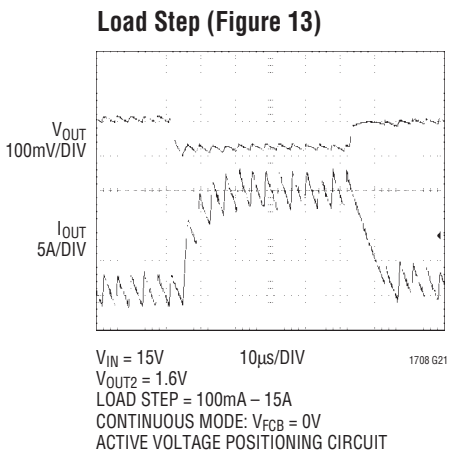
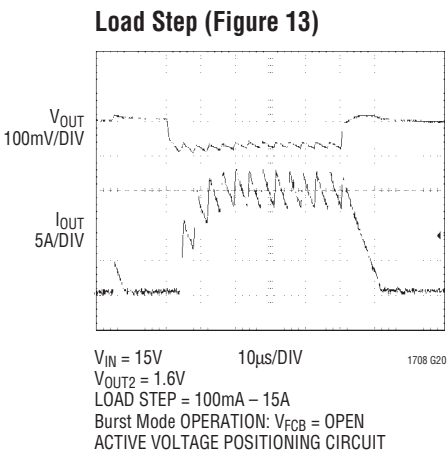
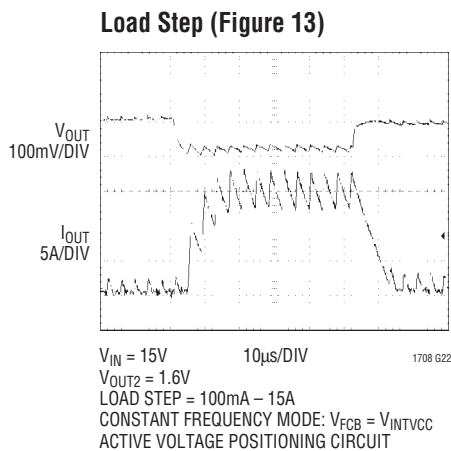
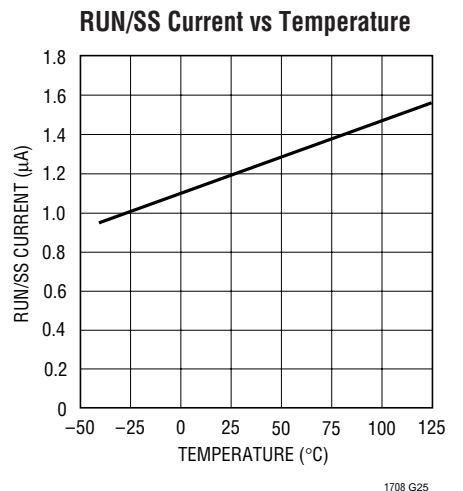
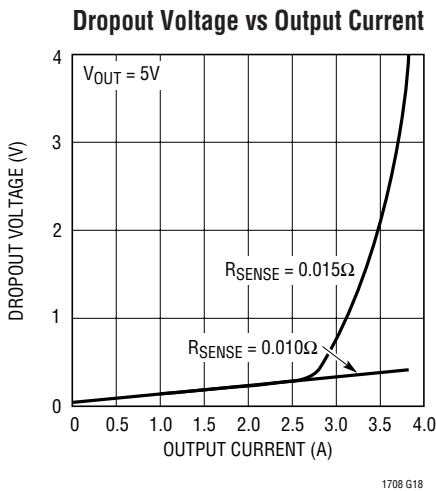
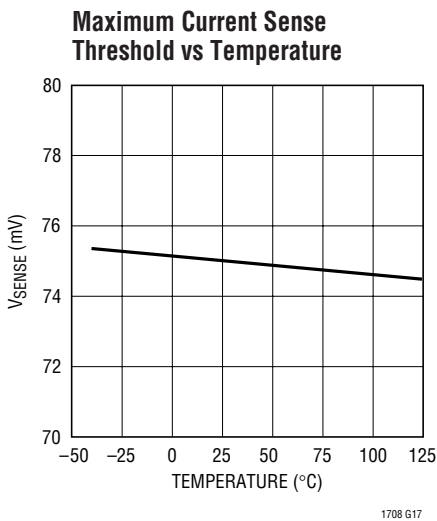
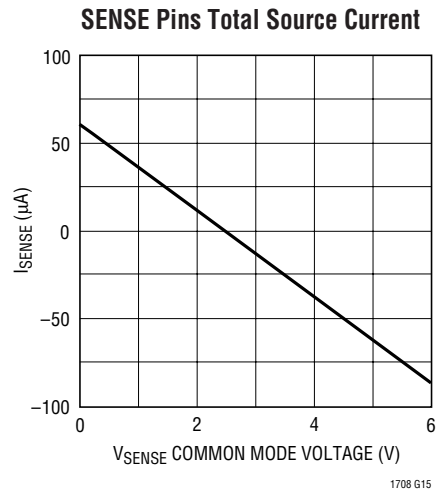
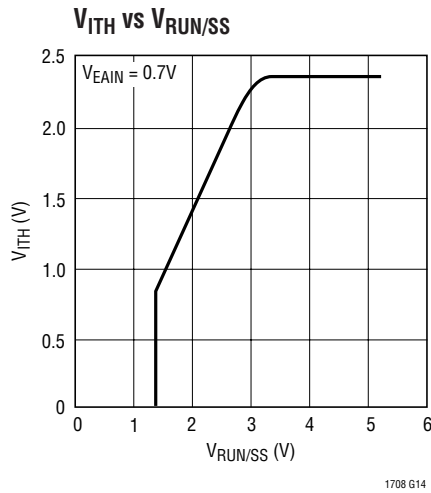
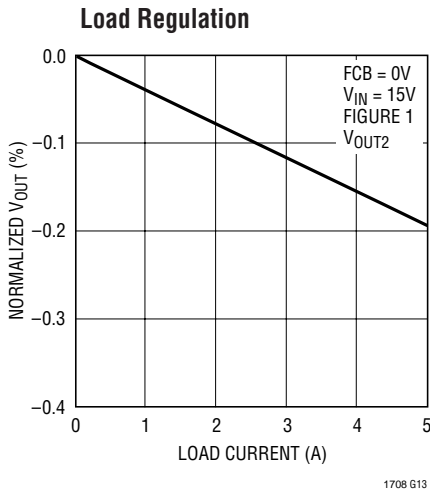

TYPICAL PERFORMANCE CHARACTERISTICS

Soft-Start Up (Figure 13)

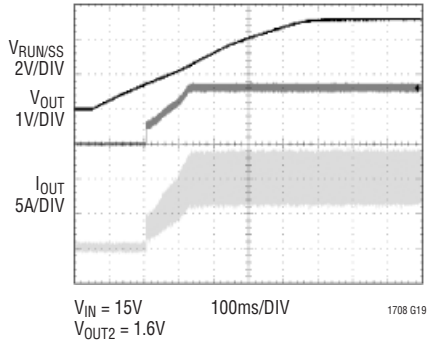

Burst Mode Operation (Figure 13)

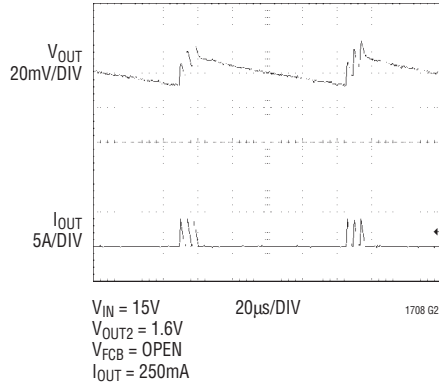

Constant Frequency (Burst Inhibit) Operation (Figure 13)

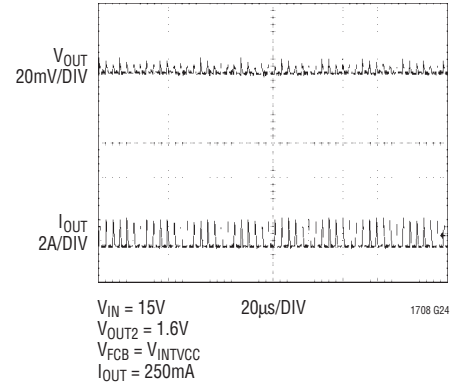

Current Sense Input Current vs Temperature

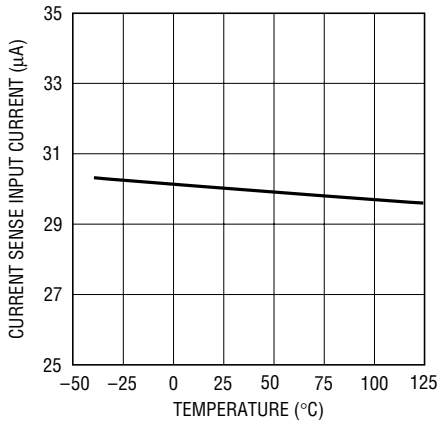

EXTV_{CC} Switch Resistance vs Temperature

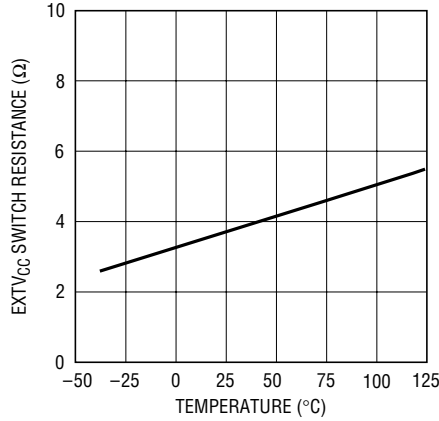

Oscillator Frequency vs Temperature

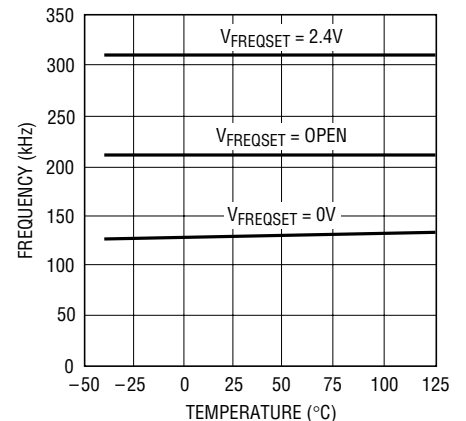

Undervoltage Lockout vs Temperature

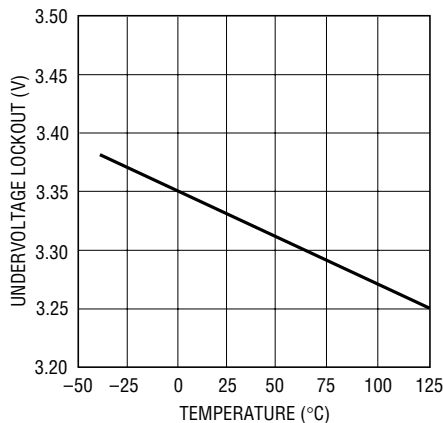

Shutdown Latch Thresholds vs Temperature

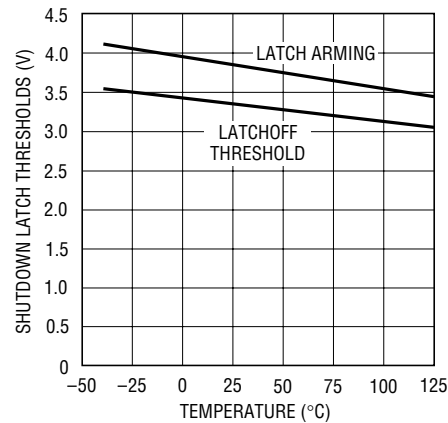

PIN FUNCTIONS

RUN/SS1, RUN/SS2 (Pins 1, 23): Combination of soft-start, run control inputs and short-circuit detection timers. A capacitor to ground at each of these pins sets the ramp time to full output current. Forcing either of these pins back below 1.0V causes the IC to shut down the circuitry required for that particular controller. Latchoff overvoltage protection is also invoked via this pin as described in the Applications Information section.

SENSE1⁺, SENSE2⁺ (Pins 2, 14): The (+) Input to the Differential Current Comparators. The I_{th} pin voltage and built-in offsets between the SENSE⁻ and SENSE⁺ pins in conjunction with R_{SENSE} sets the current trip threshold.

SENSE1⁻, SENSE2⁻ (Pins 3, 13): The (-) Input to the Differential Current Comparators.

EAIN1, EAIN2 (Pins 4, 12): Receives the remotely sensed feedback voltage for each controller from a resistive divider across the output. The VID section may be used for one resistive divider.

FREQSET (Pin 5): Frequency Control Input to the Oscillator. This pin can be left open, tied to ground, tied to $INTV_{CC}$ or driven by an external voltage source. This pin can also be used with an external phase detector to build a true phase-locked loop.

STBYMD (Pin 6): Control pin that determines which circuitry remains active when the controllers are shut down and/or provides a common control point to shut down both controllers. See the Operation section for details.

FCB (Pin 7): Forced Continuous Control Input. This input acts on both controllers and is normally used to regulate a secondary winding using a resistive divider. An applied input voltage below 0.8V will force continuous synchronous operation on both controllers. Do not leave this pin floating.

I_{TH1} , I_{TH2} (Pins 8, 11): Error Amplifier Output and Switching Regulator Compensation Point. Each associated channels' current comparator trip point increases with this control voltage.

SGND (Pin 9): Small-Signal Ground. Common to both controllers, this pin must be routed separately from high current grounds to the common (-) terminals of the C_{OUT} capacitors.

3.3V_{OUT} (Pin 10): Output of a linear regulator capable of supplying 10mA DC with peak currents as high as 50mA.

ATTNOUT (Pin 15): Divided down output voltage feeding the EAIN pin of the regulator. The VID inputs program a resistive divider between ATTNIN and SGND. ATTNOUT is the tap point on the divider. The voltage on ATTNOUT is 0.8V when the output is in regulation. This pin can be bypassed to SGND with 50pF.

ATTNIN (Pin 16): Receives the remotely sensed feedback voltage from the output.

VID0 to VID4 (Pins 17 to 21): Digital inputs for controlling the output voltage from 0.925V to 2.0V. Table 1 specifies the output voltage for the 32 combinations of digital inputs. The LSB (VID0) represents 50mV increments in the upper voltage range (2.00V to 1.30V) and 25mV increments in the lower voltage range (1.275V to 0.925V). Logic Low = GND, Logic High = $VIDV_{CC}$ or Float.

VIDV_{CC} (Pin 22): VID Input Supply Voltage. Range from 2.7V to 5.5V. Typically this pin is tied to $INTV_{CC}$.

PGND (Pin 28): Driver Power Ground. Connects to the sources of bottom (synchronous) N-channel MOSFETs, anode of the Schottky rectifier and the (-) terminal(s) of C_{IN} .

INTV_{CC} (Pin 29): Output of the Internal 5V Linear Low Dropout Regulator and the $EXTV_{CC}$ Switch. The driver and control circuits are powered from this voltage source. Must be decoupled to power ground with a minimum of 4.7 μ F tantalum or other low ESR capacitor. The $INTV_{CC}$ regulator standby function is determined by the STBYMD pin.

EXTV_{CC} (Pin 30): External Power Input to an Internal Switch Connected to $INTV_{CC}$. This switch closes and supplies V_{CC} power, bypassing the internal low dropout regulator, whenever $EXTV_{CC}$ is higher than 4.7V. See $EXTV_{CC}$ connection in Applications Information section. Do not exceed 7V on this pin.

BG1, BG2 (Pins 31, 27): High Current Gate Drives for Bottom (Synchronous) N-Channel MOSFETs. Voltage swing at these pins is from ground to $INTV_{CC}$.

V_{IN} (Pin 32): Main Supply Pin. A bypass capacitor should be tied between this pin and the signal ground pin.

PIN FUNCTIONS

BOOST1, BOOST2 (Pins 33, 26): Bootstrapped Supplies to the Topside Floating Drivers. Capacitors are connected between the boost and switch pins and Schottky diodes are tied between the boost and INTV_{CC} pins. Voltage swing at the boost pins is from INTV_{CC} to (V_{IN} + INTV_{CC}).

SW1, SW2 (Pins 34, 25): Switch Node Connections to Inductors. Voltage swing at these pins is from a Schottky diode (external) voltage drop below ground to V_{IN}.

TG1, TG2 (Pins 35, 24): High Current Gate Drives for Top N-Channel MOSFETs. These are the outputs of floating drivers with a voltage swing equal to INTV_{CC} - 0.5V superimposed on the switch node voltage SW.

PGOOD (Pin 36): Open-Drain Logic Output. PGOOD is pulled to ground when the voltage at either EAIN pin is not within 7.5% of the setpoint.

FUNCTIONAL DIAGRAM

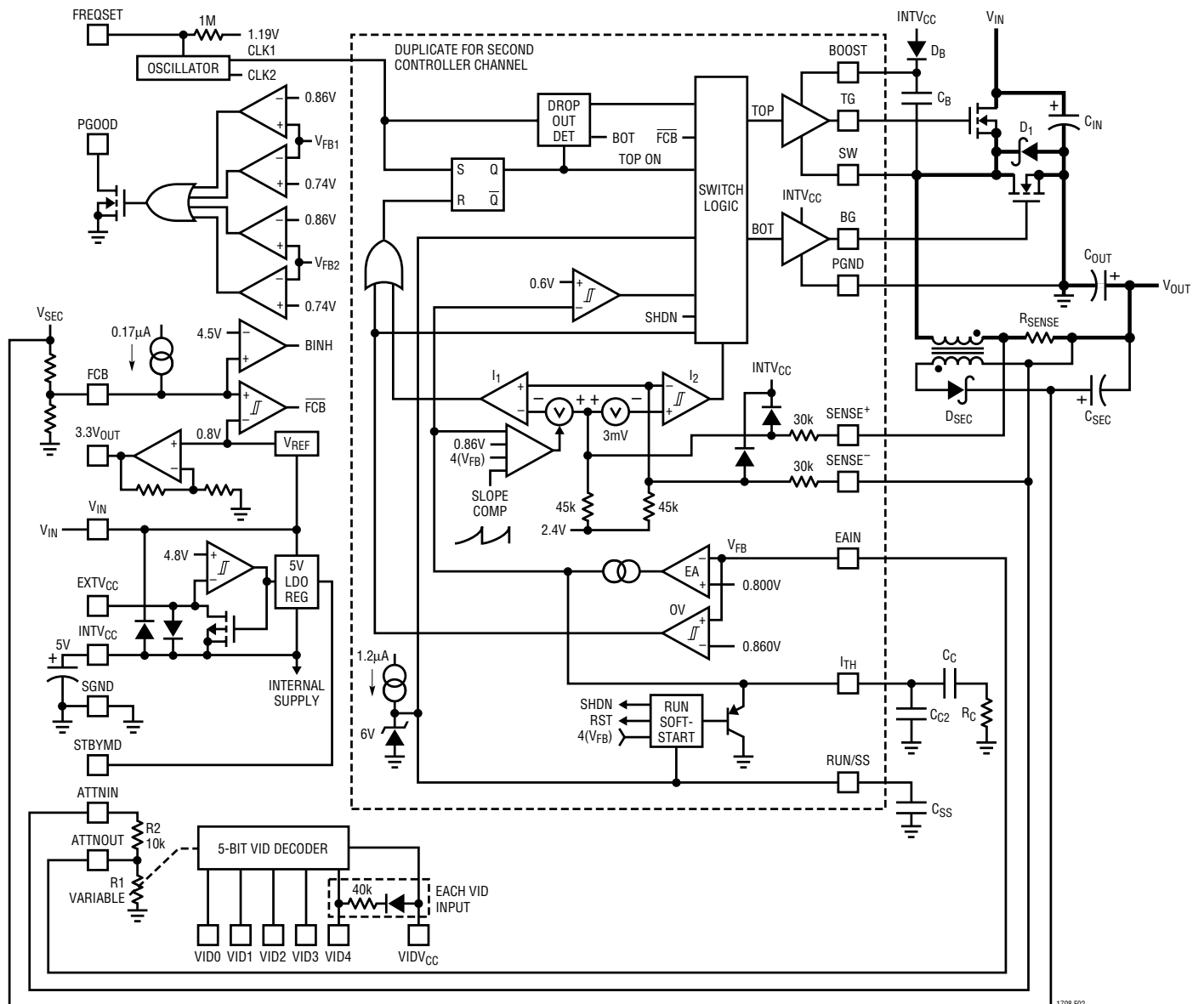

Figure 2

1708 F02

OPERATION (Refer to Functional Diagram)

Main Control Loop

The LTC1708 uses a constant frequency, current mode step-down architecture with the two controller channels operating 180 degrees out of phase. During normal operation, each top MOSFET is turned on when the clock for that channel sets the RS latch, and turned off when the main current comparator, I_1 , resets the RS latch. The peak inductor current at which I_1 resets the RS latch is controlled by the voltage on the I_{TH} pin, which is the output of each error amplifier EA. The EAIN pin receives the voltage feedback signal, which is compared to the internal reference voltage by the EA. When the load current increases, it causes a slight decrease in EAIN relative to the 0.8V reference, which in turn causes the I_{TH} voltage to increase until the average inductor current matches the new load current. After the top MOSFET has turned off, the bottom MOSFET is turned on until either the inductor current starts to reverse, as indicated by current comparator I_2 , or the beginning of the next cycle.

The top MOSFET drivers are biased from floating bootstrap capacitor C_B , which normally is recharged during each off cycle through an external diode when the top MOSFET turns off. As V_{IN} decreases to a voltage close to V_{OUT} , the loop may enter dropout and attempt to turn on the top MOSFET continuously. The dropout detector detects this and forces the top MOSFET off for about 500ns every tenth cycle to allow C_B to recharge.

The main control loop is shut down by pulling the RUN/SS pin low. Releasing RUN/SS allows an internal 1.2 μ A current source to charge soft-start capacitor C_{SS} . When C_{SS} reaches 1.5V, the main control loop is enabled with the I_{TH} voltage clamped at approximately 30% of its maximum value. As C_{SS} continues to charge, the I_{TH} pin voltage is gradually released allowing normal, full-current operation. When both RUN/SS1 and RUN/SS2 are low, all LTC1708 controller functions are shut down, and the STBYMD pin determines if the standby 5V and 3.3V regulators are kept alive.

Low Current Operation

The FCB pin is a multifunction pin providing two functions: 1) to provide regulation for a secondary winding by temporarily forcing continuous PWM operation on

controller 1 and 2) select between *two* modes of low current operation. When the FCB pin voltage is below 0.8V, the controller forces continuous PWM current mode operation. In this mode, the top and bottom MOSFETs are alternately turned on to maintain the output voltage independent of direction of inductor current. When the FCB pin is below $V_{INTVCC} - 2V$ but greater than 0.8V, the controller enters Burst Mode operation. Burst Mode operation sets a minimum output current level before inhibiting the top switch and turns off the synchronous MOSFET(s) when the inductor current goes negative. This combination of requirements will, at low currents, force the I_{TH} pin below a voltage threshold that will temporarily inhibit turn-on of both output MOSFETs until the output voltage drops. There is 60mV of hysteresis in the burst comparator B tied to the I_{TH} pin. This hysteresis produces output signals to the MOSFETs that turn them on for several cycles, followed by a variable “sleep” interval depending upon the load current. The resultant output voltage ripple is held to a very small value by having the hysteretic comparator after the error amplifier gain block.

Constant Frequency Operation

When the FCB pin is tied to $INTV_{CC}$, Burst Mode operation is disabled and the forced minimum output current requirement is removed. This provides constant frequency, discontinuous (preventing reverse inductor current) current operation over the widest possible output current range. This constant frequency operation is not as efficient as Burst Mode operation, but does provide a lower noise, constant frequency operating mode down to approximately 1% of designed maximum output current.

Continuous Current (PWM) Operation

Tying the FCB pin to ground will force continuous current operation. This is the least efficient operating mode, but may be desirable in certain applications. The output can source or sink current in this mode. When sinking current while in forced continuous operation, current will be forced back into the main power supply potentially boosting the input supply to dangerous voltage levels—**BEWARE!**

OPERATION (Refer to Functional Diagram)

Frequency Setting

The FREQSET pin provides frequency adjustment of the internal oscillator from approximately 140kHz to 310kHz. This input is nominally biased through an internal resistor to the 1.19V reference, setting the oscillator frequency to approximately 220kHz. This pin can be driven from an external AC or DC signal source to control the instantaneous frequency of the oscillator.

INTV_{CC}/EXTV_{CC} Power

Power for the top and bottom MOSFET drivers and most other internal circuitry is derived from the INTV_{CC} pin. When the EXTV_{CC} pin is left open, an internal 5V low dropout linear regulator supplies INTV_{CC} power. If EXTV_{CC} is taken above 4.7V, the 5V regulator is turned off and an internal switch is turned on connecting EXTV_{CC} to INTV_{CC}. This allows the INTV_{CC} power to be derived from a high efficiency external source such as the output of the regulator itself or a secondary winding, as described in the Applications Information.

Standby Mode Pin

The STBYMD pin is a three-state input that controls common circuitry within the IC as follows: When the STBYMD pin is held at ground, both controller RUN/SS pins are pulled to ground providing a single control pin to shut down both controllers. When the pin is left open, the internal RUN/SS currents are enabled to charge the RUN/SS capacitor(s), allowing the turn-on of either controller and activating necessary common internal biasing. When the STBYMD pin is taken above 2V, both internal linear regulators are turned on independent of the state on the RUN/SS pins of the two switching regulator controllers, providing an output power source for “wake-up” circuitry. Decouple the pin with a small capacitor (0.01μF) to ground if the pin is not connected to a DC potential.

Output Overvoltage Protection

An overvoltage comparator, OV, guards against transient overshoots (>7.5%) as well as other more serious conditions that may overvoltage the output. In this case, the top MOSFET is turned off and the bottom MOSFET is turned on until the overvoltage condition is cleared.

VID Control

Logic inputs VID0 to VID4 program an internal resistive divider. The output voltage can be programmed in 50mV and 25mV increments from 0.925V to 2.0V (see Table 1). These logic input pins are internally pulled up to the VIDV_{CC} pin using separate internal series resistor/diode paths. The diodes provide electrical isolation when the logic pins are externally pulled up to a higher voltage supply than VIDV_{CC}.

Power Good (PGOOD)

The PGOOD pin is connected to an open drain of an internal MOSFET. The MOSFET turns on when the outputs are not both within $\pm 7.5\%$ of their nominal output levels as determined by their feedback dividers. When both outputs are within $\pm 7.5\%$ of their nominal values, the MOSFET is turned off within 10μs and the pin is pulled up by an external source

Foldback Current, Short-Circuit Detection and Short-Circuit Latchoff

The RUN/SS capacitors are used initially to limit the inrush current of each switching regulator. After the controller has been started and been given adequate time to charge up the output capacitors and provide full load current, the RUN/SS capacitor is used in a short-circuit time-out circuit. If the output voltage falls to less than 70% of its nominal output voltage, the RUN/SS capacitor begins discharging on the assumption that the output is in an overcurrent and/or short-circuit condition. If the condition lasts for a long enough period as determined by the size of the RUN/SS capacitor, both controllers will be shut down until the RUN/SS pin's voltages are recycled. This built-in latchoff can be overridden by providing a >5μA pull-up at a compliance of 5V to the RUN/SS pin(s). This current shortens the soft-start period but also prevents net discharge of the RUN/SS capacitor(s) during an overcurrent and/or short-circuit condition. Foldback current limiting is also activated when the output voltage falls below 70% of its nominal level whether or not the short-circuit latchoff circuit is enabled. Even if a short is present and the short-circuit latchoff is not enabled, a safe, low output current is provided due to internal current foldback and actual power

OPERATION (Refer to Functional Diagram)

wasted is low due to the efficient nature of the current mode switching regulator.

THEORY AND BENEFITS OF 2-PHASE OPERATION

The LTC1708 dual high efficiency DC/DC controller, like the LTC1628, brings the considerable benefits of 2-phase operation to portable applications for the first time. Notebook computers, PDAs, handheld terminals and automotive electronics will all benefit from the lower input filtering requirement, reduced electromagnetic interference (EMI) and increased efficiency associated with 2-phase operation.

Why the need for 2-phase operation? Up until the LTC1628, constant-frequency dual switching regulators operated both channels in phase (i.e., single-phase operation). This means that both switches turned on at the same time, causing current pulses of up to twice the amplitude of those for one regulator to be drawn from the input capacitor and battery. These large amplitude current pulses increased the total RMS current flowing from the input capacitor, requiring the use of more expensive input capacitors and increasing both EMI and losses in the input capacitor and battery.

With 2-phase operation, the two channels of the dual-switching regulator are operated 180 degrees out of phase. This effectively interleaves the current pulses drawn by the switches, greatly reducing the overlap time where they add together. *The result is a significant reduction in total RMS input current, which in turn allows less*

expensive input capacitors to be used, reduces shielding requirements for EMI and improves real world operating efficiency.

Figure 3 compares the input waveforms for a representative single-phase dual switching regulator to the new LTC1628 2-phase dual switching regulator. An actual measurement of the RMS input current under these conditions shows that 2-phase operation dropped the input current from $2.53A_{RMS}$ to $1.55A_{RMS}$. While this is an impressive reduction in itself, remember that the power losses are proportional to I_{RMS}^2 , meaning that the actual power wasted is reduced by a factor of 2.66. The reduced input ripple voltage also means less power is lost in the input power path, which could include batteries, switches, trace/connector resistances and protection circuitry. Improvements in both conducted and radiated EMI also directly accrue as a result of the reduced RMS input current and voltage.

Of course, the improvement afforded by 2-phase operation is a function of the dual switching regulator's relative duty cycles which, in turn, are dependent upon the input voltage V_{IN} (Duty Cycle = V_{OUT}/V_{IN}). Figure 4 shows how the RMS input current varies for single-phase and 2-phase operation for 3.3V and 5V regulators over a wide input voltage range.

It can readily be seen that the advantages of 2-phase operation are not just limited to a narrow operating range, but in fact extend over a wide region. A good rule of thumb

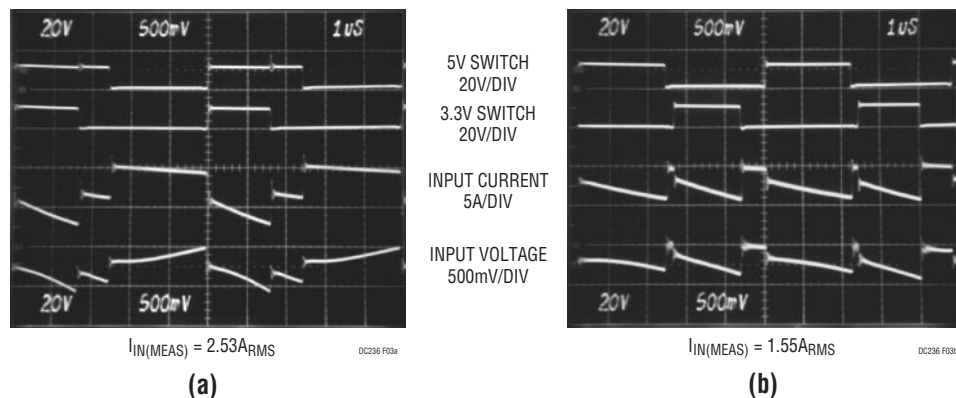

Figure 3. Input Waveforms Comparing Single-Phase (a) and 2-Phase (b) Operation for Dual Switching Regulators Converting 12V to 5V and 3.3V at 3A Each. The Reduced Input Ripple with the LTC1628 2-Phase Regulator Allows Less Expensive Input Capacitors, Reduces Shielding Requirements for EMI and Improves Efficiency

OPERATION (Refer to Functional Diagram)

for most applications is that 2-phase operation will reduce the input capacitor requirement to that for just one channel operating at maximum current and 50% duty cycle.

A final question: If 2-phase operation offers such an advantage over single-phase operation for dual switching regulators, why hasn't it been done before? The answer is that, while simple in concept, it is hard to implement. Constant-frequency current mode switching regulators require an oscillator derived "slope compensation" signal to allow stable operation of each regulator at over 50% duty cycle. This signal is relatively easy to derive in single-phase dual switching regulators, but required the development of a new and proprietary technique to allow 2-phase operation. In addition, isolation between the two channels becomes more critical with 2-phase operation because switch transitions in one channel could potentially disrupt the operation of the other channel.

The LTC1708 is proof that these hurdles have been surmounted. The new device offers unique advantages for the ever-expanding number of high efficiency power supplies required in portable electronics.

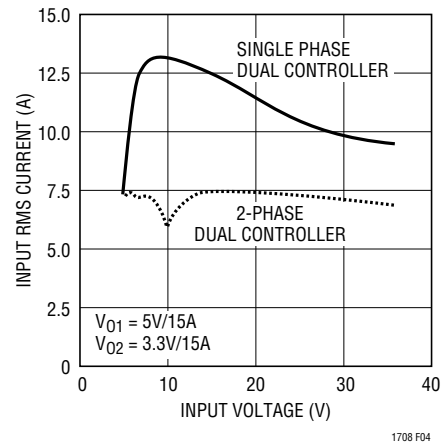

Figure 4. RMS Input Current Comparison

APPLICATIONS INFORMATION

Figure 1 on the first page is a basic LTC1708 application circuit. External component selection is driven by the load requirement, and begins with the selection of R_{SENSE} . Once R_{SENSE} is known, L can be chosen. Next, the power MOSFETs and D1 are selected. Finally, C_{IN} and C_{OUT} are selected. The circuit shown in Figure 1 can be configured for operation up to an input voltage of 28V (limited by the external MOSFETs).

R_{SENSE} Selection For Output Current

R_{SENSE} is chosen based on the required output current. The LTC1708 current comparator has a maximum threshold of $75\text{mV}/R_{SENSE}$ and an input common mode range of SGND to $1.1(\text{INTV}_{CC})$. The current comparator threshold sets the peak of the inductor current, yielding a maximum average output current I_{MAX} equal to the peak value less half the peak-to-peak ripple current, ΔI_L .

Allowing a margin for variations in the LTC1708 and external component values yields:

$$R_{SENSE} = \frac{50\text{mV}}{I_{MAX}}$$

When using the controller in very low dropout conditions, the maximum output current level will be reduced due to the internal compensation required to meet stability criterion for buck regulators operating at greater than 50% duty factor. A curve is provided to estimate this reduction in peak output current level depending upon the operating duty factor.

Selection of Operating Frequency

The LTC1708 uses a constant frequency architecture with the frequency determined by an internal oscillator capacitor. This internal capacitor is charged by a fixed current plus an additional current that is proportional to the voltage applied to the FREQSET pin.

A graph for the voltage applied to the FREQSET pin vs frequency is given in Figure 5. As the operating frequency is increased the gate charge losses will be higher, reducing efficiency (see Efficiency Considerations). The maximum switching frequency is approximately 310kHz.

APPLICATIONS INFORMATION

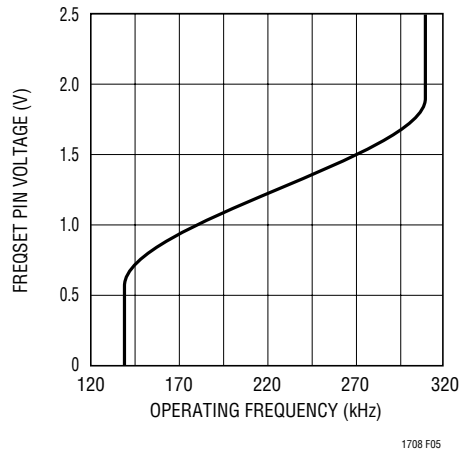

Figure 5. FREQSET Pin Voltage vs Frequency

Inductor Value Calculation

The operating frequency and inductor selection are inter-related in that higher operating frequencies allow the use of smaller inductor and capacitor values. So why would anyone ever choose to operate at lower frequencies with larger components? The answer is efficiency. A higher frequency generally results in lower efficiency because of MOSFET gate charge losses. In addition to this basic trade-off, the effect of inductor value on ripple current and low current operation must also be considered.

The inductor value has a direct effect on ripple current. The inductor ripple current ΔI_L decreases with higher inductance or frequency and increases with higher V_{IN} :

$$\Delta I_L = \frac{1}{(f)(L)} V_{OUT} \left(1 - \frac{V_{OUT}}{V_{IN}} \right)$$

Accepting larger values of ΔI_L allows the use of low inductances, but results in higher output voltage ripple and greater core losses. A reasonable starting point for setting ripple current is $\Delta I_L = 0.3(I_{MAX})$. Remember, the maximum ΔI_L occurs at the maximum input voltage.

The inductor value also has secondary effects. The transition to Burst Mode operation begins when the average inductor current required results in a peak current below 25% of the current limit determined by R_{SENSE} . Lower inductor values (higher ΔI_L) will cause this to occur at lower load currents, which can cause a dip in efficiency in

the upper range of low current operation. In Burst Mode operation, lower inductance values will cause the burst frequency to decrease.

Inductor Core Selection

Once the value for L is known, the type of inductor must be selected. High efficiency converters generally cannot afford the core loss found in low cost powdered iron cores, forcing the use of more expensive ferrite, molypermalloy, or Kool M μ ® cores. Actual core loss is independent of core size for a fixed inductor value, but it is very dependent on inductance selected. As inductance increases, core losses go down. Unfortunately, increased inductance requires more turns of wire and therefore copper losses will increase.

Ferrite designs have very low core loss and are preferred at high switching frequencies, so design goals can concentrate on copper loss and preventing saturation. Ferrite core material saturates “hard,” which means that inductance collapses abruptly when the peak design current is exceeded. This results in an abrupt increase in inductor ripple current and consequent output voltage ripple. Do not allow the core to saturate!

Molypermalloy (from Magnetics, Inc.) is a very good, low loss core material for toroids, but it is more expensive than ferrite. A reasonable compromise from the same manufacturer is Kool M μ . Toroids are very space efficient, especially when you can use several layers of wire. Because they generally lack a bobbin, mounting is more difficult. However, designs for surface mount are available that do not increase the height significantly.

Power MOSFET and D1 Selection

Two external power MOSFETs must be selected for each controller with the LTC1708: One N-channel MOSFET for each top (main) switch, and one N-channel MOSFET for each bottom (synchronous) switch.

The peak-to-peak drive levels are set by the $INTV_{CC}$ voltage. This voltage is typically 5V during start-up (see $EXTV_{CC}$ Pin Connection). Consequently, logic-level threshold MOSFETs must be used in most applications. The only exception is if low input voltage is expected ($V_{IN} < 5V$);

Kool M μ is a registered trademark of Magnetics, Inc.

APPLICATIONS INFORMATION

then, sub-logic level threshold MOSFETs ($V_{GS(TH)} < 3V$) should be used. Pay close attention to the BV_{DSS} specification for the MOSFETs as well; most of the logic level MOSFETs are limited to 30V or less.

Selection criteria for the power MOSFETs include the “on” resistance $R_{SD(ON)}$, input capacitance, input voltage and maximum output current.

MOSFET input capacitance is a combination of several components but can be taken from the typical “gate charge” curve included on most data sheets (Figure 6). The curve is generated by forcing a constant input current into the gate of a common source, current source loaded stage and then plotting the gate voltage versus time. The initial slope is the effect of the gate-to-source and the gate-to-drain capacitance. The flat portion of the curve is the result of the Miller capacitance effect of the drain-to-source capacitance as the drain drops the voltage across the current source load. The upper sloping line is due to the drain-to-gate accumulation capacitance and the gate-to-source capacitance. The Miller charge (the increase in coulombs on the horizontal axis from a to b while the curve is flat) is specified for a given V_{DS} drain voltage, but can be adjusted for different V_{DS} voltages by multiplying by the ratio of the application V_{DS} to the curve specified V_{DS} values. A way to estimate the C_{MILLER} term is to take the change in gate charge from points a and b on a manufacturer's data sheet and divide by the stated V_{DS} voltage specified. C_{MILLER} is the most important selection criteria for determining the transition loss term in the top MOSFET but is not directly specified on MOSFET data sheets. C_{RSS} and C_{OS} are specified sometimes but definitions of these parameters are not included.

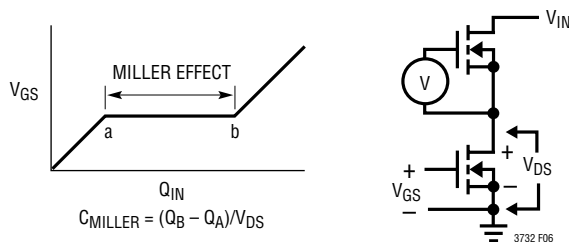

Figure 6. Gate Charge Characteristic

When the controller is operating in continuous mode the duty cycles for the top and bottom MOSFETs are given by:

$$\text{Main Switch Duty Cycle} = \frac{V_{OUT}}{V_{IN}}$$

$$\text{Synchronous Switch Duty Cycle} = \left(\frac{V_{IN} - V_{OUT}}{V_{IN}} \right)$$

The power dissipation for the main and synchronous MOSFETs at maximum output current are given by:

$$P_{MAIN} = \frac{V_{OUT}}{V_{IN}} \left(\frac{I_{MAX}}{N} \right)^2 (1 + \delta) R_{DS(ON)} +$$

$$V_{IN}^2 \frac{I_{MAX}}{2N} (R_{DR}) (C_{MILLER}) \cdot$$

$$\left[\frac{1}{V_{CC} - V_{TH}} + \frac{1}{V_{TH}} \right] (f)$$

$$P_{SYNC} = \frac{V_{IN} - V_{OUT}}{V_{IN}} \left(\frac{I_{MAX}}{N} \right)^2 (1 + \delta) R_{DS(ON)}$$

where N is the number of output stages, δ is the temperature dependency of $R_{DS(ON)}$, R_{DR} is the effective top driver resistance (approximately 4Ω at $V_{GS} = V_{MILLER}$), V_{IN} is the drain potential *and* the change in drain potential in the particular application. V_{TH} is the data sheet specified typical gate threshold voltage specified in the power MOSFET data sheet at the operating drain current. C_{MILLER} is the calculated capacitance using the gate charge curve from the MOSFET data sheet and the technique described above.

The term $(1+\delta)$ is generally given for a MOSFET in the form of a normalized $R_{DS(ON)}$ vs Temperature curve, but $\delta = 0.005/^{\circ}C$ can be used as an approximation for low voltage MOSFETs.

The Schottky diode D1 shown in Figure 1 conducts during the dead-time between the conduction of the two power MOSFETs. This prevents the body diode of the bottom MOSFET from turning on, storing charge during the dead-time and requiring a reverse recovery period that could cost as much as 3% in efficiency at high V_{IN} . A 1A to 3A Schottky is generally a good compromise for both regions of operation due to the relatively small average current. Larger diodes result in additional transition losses due to their larger junction capacitance.

APPLICATIONS INFORMATION

C_{IN} and C_{OUT} Selection

The selection of C_{IN} is simplified by the multiphase architecture and its impact on the worst-case RMS current drawn through the input network (battery/fuse/capacitor). It can be shown that the worst case RMS current occurs when only one controller is operating. The controller with the highest $(V_{OUT})(I_{OUT})$ product needs to be used in the formula below to determine the maximum RMS current requirement. Increasing the output current, drawn from the other out-of-phase controller, will actually decrease the input RMS ripple current from this maximum value (see Figure 4). The out-of-phase technique typically reduces the input capacitor's RMS ripple current by a factor of 30% to 70% when compared to a single phase power supply solution.

The type of input capacitor, value and ESR rating have efficiency effects that need to be considered in the selection process. The capacitance value chosen should be sufficient to store adequate charge to keep high peak battery currents down. 20 μ F to 40 μ F is usually sufficient for a 25W output supply operating at 200kHz. The ESR of the capacitor is important for capacitor power dissipation as well as overall battery efficiency. All of the power (RMS ripple current • ESR) not only heats up the capacitor but wastes power from the battery.

Medium voltage (20V to 35V) ceramic, tantalum, OS-CON and switcher-rated electrolytic capacitors can be used as input capacitors, but each has drawbacks: ceramic voltage coefficients are very high and may have audible piezoelectric effects; tantalums need to be surge-rated; OS-CONS suffer from higher inductance, larger case size and limited surface-mount applicability; electrolytics' higher ESR and dryout possibility require several to be used. Multiphase systems allow the lowest amount of capacitance overall. As little as one 22 μ F or two to three 10 μ F ceramic capacitors are an ideal choice in a 20W to 35W power supply due to their extremely low ESR. Even though the capacitance at 20V is substantially below their rating at zero-bias, very low ESR loss makes ceramics an ideal candidate for highest efficiency battery operated systems. Also consider parallel ceramic and high quality electrolytic capacitors as an effective means of achieving ESR and bulk capacitance goals.

In continuous mode, the source current of the top N-channel MOSFET is a square wave of duty cycle V_{OUT}/V_{IN} . To prevent large voltage transients, a low ESR input capacitor sized for the maximum RMS current of one channel must be used. The maximum RMS capacitor current is given by:

$$C_{IN} \text{ Required } I_{RMS} \approx I_{MAX} \frac{[V_{OUT}(V_{IN} - V_{OUT})]^{1/2}}{V_{IN}}$$

This formula has a maximum at $V_{IN} = 2V_{OUT}$, where $I_{RMS} = I_{OUT}/2$. This simple worst case condition is commonly used for design because even significant deviations do not offer much relief. Note that capacitor manufacturer's ripple current ratings are often based on only 2000 hours of life. This makes it advisable to further derate the capacitor, or to choose a capacitor rated at a higher temperature than required. Several capacitors may also be paralleled to meet size or height requirements in the design. Always consult the manufacturer if there is any question.

The benefit of the LTC1708 multiphase can be calculated by using the equation above for the higher power controller and then calculating the loss that would have resulted if both controller channels switch on at the same time. The total RMS power lost is lower when both controllers are operating due to the interleaving of current pulses through the input capacitor's ESR. This is why the input capacitor's requirement calculated above for the worst-case controller is adequate for the dual controller design. Remember that input protection fuse resistance, battery resistance and PC board trace resistance losses are also reduced due to the reduced peak currents in a multiphase system. *The overall benefit of a multiphase design will only be fully realized when the source impedance of the power supply/battery is included in the efficiency testing.* The drains of the two top MOSFETS should be placed within 1cm of each other and share a common $C_{IN}(s)$. Separating the drains and C_{IN} may produce undesirable voltage and current resonances at V_{IN} .

The selection of C_{OUT} is driven by the required effective series resistance (ESR). Typically once the ESR requirement is satisfied the capacitance is adequate for filtering. The output ripple (ΔV_{OUT}) is determined by:

APPLICATIONS INFORMATION

$$\Delta V_{OUT} \approx \Delta I_L \left(ESR + \frac{1}{8fC_{OUT}} \right)$$

Where f = operating frequency, C_{OUT} = output capacitance, and ΔI_L = ripple current in the inductor. The output ripple is highest at maximum input voltage since ΔI_L increases with input voltage. With $\Delta I_L = 0.3I_{OUT(MAX)}$ the output ripple will typically be less than 50mV at max V_{IN} assuming:

$$C_{OUT} \text{ Recommended } ESR < 2 R_{SENSE}$$

$$\text{and } C_{OUT} > 1/(8fR_{SENSE})$$

The first condition relates to the ripple current into the ESR of the output capacitance while the second term guarantees that the output capacitance does not significantly discharge during the operating frequency period due to ripple current. The choice of using smaller output capacitance increases the ripple voltage due to the discharging term but can be compensated for by using capacitors of very low ESR to maintain the ripple voltage at or below 50mV. The I_{TH} pin OPTI-LOOP compensation components can be optimized to provide stable, high performance transient response regardless of the output capacitors selected.

Manufacturers such as Nichicon, United Chemicon and Sanyo can be considered for high performance through-hole capacitors. The OS-CON semiconductor dielectric capacitor available from Sanyo has the lowest (ESR)(size) product of any aluminum electrolytic at a somewhat higher price. An additional ceramic capacitor in parallel with OS-CON capacitors is recommended to reduce the inductance effects.

In surface mount applications multiple capacitors may need to be used in parallel to meet the ESR, RMS current handling and load step requirements of the application. Aluminum electrolytic, dry tantalum and special polymer capacitors are available in surface mount packages. Special polymer surface mount capacitors offer very low ESR but have lower storage capacity per unit volume than other capacitor types. These capacitors offer a very cost-effective output capacitor solution and are an ideal choice when combined with a controller having high loop bandwidth. Tantalum capacitors offer the highest capacitance density

and are often used as output capacitors for switching regulators having controlled soft-start. Several excellent surge-tested choices are the AVX TPS, AVX TPSV or the KEMET T510 series of surface mount tantalums, available in case heights ranging from 2mm to 4mm. Aluminum electrolytic capacitors can be used in cost-driven applications providing that consideration is given to ripple current ratings, temperature and long term reliability. A typical application will require several to many aluminum electrolytic capacitors in parallel. A combination of the above mentioned capacitors will often result in maximizing performance and minimizing overall cost. Other capacitor types include Nichicon PL series, NEC Neocap, Panasonic SP and Sprague 595D series. Consult manufacturers for other specific recommendations.

INTV_{CC} Regulator

An internal P-channel low dropout regulator produces 5V at the INTV_{CC} pin from the V_{IN} supply pin. INTV_{CC} powers the drivers and internal circuitry within the LTC1708. The INTV_{CC} pin regulator can supply a peak current of 50mA and must be bypassed to ground with a minimum of 4.7 μ F tantalum, 10 μ F special polymer, or low ESR type electrolytic capacitor. A 1 μ F ceramic capacitor placed directly adjacent to the INTV_{CC} and PGND IC pins is highly recommended. Good bypassing is necessary to supply the high transient currents required by the MOSFET gate drivers and to prevent interaction between channels.

Higher input voltage applications in which large MOSFETs are being driven at high frequencies may cause the maximum junction temperature rating for the LTC1708 to be exceeded. The system supply current is normally dominated by the gate charge current. Additional external loading of the INTV_{CC} and 3.3V linear regulators also needs to be taken into account for the power dissipation calculations. The total INTV_{CC} current can be supplied by either the 5V internal linear regulator or by the EXTV_{CC} input pin. When the voltage applied to the EXTV_{CC} pin is less than 4.7V, all of the INTV_{CC} current is supplied by the internal 5V linear regulator. Power dissipation for the IC in this case is highest: $(V_{IN})(I_{INTVCC})$, and overall efficiency is lowered. The gate charge current is dependent on operating frequency as discussed in the Efficiency Considerations section. The junction temperature can be esti-

APPLICATIONS INFORMATION

Topside MOSFET Driver Supply (C_B , D_B)

External bootstrap capacitors C_B connected to the BOOST pins supply the gate drive voltages for the topside MOSFETs. Capacitor C_B in the functional diagram is charged through external diode D_B from $INTV_{CC}$ when the SW pin is low. When one of the topside MOSFETs is to be turned on, the driver places the C_B voltage across the gate-source of the desired MOSFET. This enhances the MOSFET and turns on the topside switch. The switch node voltage, SW, rises to V_{IN} and the BOOST pin follows. With the topside MOSFET on, the boost voltage is above the input supply: $V_{BOOST} = V_{IN} + V_{INTVCC}$. The value of the boost capacitor C_B needs to be 100 times that of the total input capacitance of the topside MOSFET(s). The reverse breakdown of the external Schottky diode must be greater than $V_{IN(MAX)}$. When adjusting the gate drive level, the final arbiter is the total input current for the regulator. If a change is made and the input current decreases, then the efficiency has improved. If there is no change in input current, then there is no change in efficiency.

Output Voltage Programming

The LTC1708 output voltages are set by the VID logic inputs for the first controller and by an external feedback resistive divider carefully placed across the output capacitor for the second controller. The resultant feedback signal is compared with the internal precision 0.800V voltage reference by the error amplifier. The output voltage is given by the equation:

$$V_{OUT} = 0.8V \left(1 + \frac{R2}{R1} \right)$$

The output voltage of the first controller is digitally set to levels between 0.925V and 2.00V using the voltage identification (VID) inputs VID0 to VID4. The internal 5-bit DAC configured as a precision resistive voltage divider sets the output voltage in 50mV or 25mV increments according to Table 1.

The VID codes (00000-11110) are engineered to be compatible with Intel Mobile Pentium® II and Pentium III processor specifications for output voltages from 0.925V to 2.00V.

The LSB (VID0) represents 50mV increments in the upper voltage range (1.30V to 2.00V) and 25mV increments in the lower voltage range (0.925V to 1.275V). The MSB is VID4. When all bits are low, or grounded, the output voltage is 2.00V.

Table 1. VID Output Voltage Programming

| VID4 | VID3 | VID2 | VID1 | VID0 | V_{OUT} (V) |
|------|------|------|------|------|---------------|
| 0 | 0 | 0 | 0 | 0 | 2.000V |
| 0 | 0 | 0 | 0 | 1 | 1.950V |
| 0 | 0 | 0 | 1 | 0 | 1.900V |
| 0 | 0 | 0 | 1 | 1 | 1.850V |
| 0 | 0 | 1 | 0 | 0 | 1.800V |
| 0 | 0 | 1 | 0 | 1 | 1.750V |
| 0 | 0 | 1 | 1 | 0 | 1.700V |
| 0 | 0 | 1 | 1 | 1 | 1.650V |
| 0 | 1 | 0 | 0 | 0 | 1.600V |
| 0 | 1 | 0 | 0 | 1 | 1.550V |
| 0 | 1 | 0 | 1 | 0 | 1.500V |
| 0 | 1 | 0 | 1 | 1 | 1.450V |
| 0 | 1 | 1 | 0 | 0 | 1.400V |
| 0 | 1 | 1 | 0 | 1 | 1.350V |
| 0 | 1 | 1 | 1 | 0 | 1.300V |
| 0 | 1 | 1 | 1 | 1 | * |
| 1 | 0 | 0 | 0 | 0 | 1.275V |
| 1 | 0 | 0 | 0 | 1 | 1.250V |
| 1 | 0 | 0 | 1 | 0 | 1.225V |
| 1 | 0 | 0 | 1 | 1 | 1.200V |
| 1 | 0 | 1 | 0 | 0 | 1.175V |
| 1 | 0 | 1 | 0 | 1 | 1.150V |
| 1 | 0 | 1 | 1 | 0 | 1.125V |
| 1 | 0 | 1 | 1 | 1 | 1.100V |
| 1 | 1 | 0 | 0 | 0 | 1.075V |
| 1 | 1 | 0 | 0 | 1 | 1.050V |
| 1 | 1 | 0 | 1 | 0 | 1.025V |
| 1 | 1 | 0 | 1 | 1 | 1.000V |
| 1 | 1 | 1 | 0 | 0 | 0.975V |
| 1 | 1 | 1 | 0 | 1 | 0.950V |
| 1 | 1 | 1 | 1 | 0 | 0.925V |
| 1 | 1 | 1 | 1 | 1 | ** |

Note: *, ** represent codes without a defined output voltage as specified in Intel specifications. The LTC1708 interprets these codes as valid inputs and produces output voltages as follows: [01111] = 1.250V, [11111] = 0.900V.

APPLICATIONS INFORMATION

Between the ATTNOUT pin and ground is a variable resistor, R1, whose value is controlled by the five input pins (VID0 to VID4). Another resistor, R2, between the ATTNIN and the ATTNOUT pins completes the resistive divider. The output voltage is thus set by the ratio of (R1 + R2) to R1.

The LTC1708 has remote sense capability. The top of the internal resistive divider is connected to ATTNIN, and it is referenced to the SGND pin. This allows a Kelvin connection for remotely sensing the output voltage directly across the load, eliminating any PC board trace resistance errors.

Each VID digital input is pulled up by a 40k resistor in series with a diode from VIDV_{CC}. Therefore, it must be grounded to get a digital low input, and can be either floated or connected to VIDV_{CC} to get a digital high input. The series diode is used to prevent the digital inputs from being damaged or clamped if they are driven higher than VIDV_{CC}. The digital inputs accept CMOS voltage levels.

VIDV_{CC} is the supply voltage for the VID section. It is normally connected to INTV_{CC} but can be driven from other sources such as a 3.3V supply. If it is driven from another source, that source MUST be in the range of 2.7V to 5.5V and MUST be alive prior to enabling the LTC1708.

SENSE+/SENSE- Pins

The common mode input range of the current comparator sense pins is from 0V to (1.1)INTV_{CC}. Continuous linear operation is guaranteed throughout this range allowing output voltage setting from 0.8V to 7.7V, depending upon the voltage applied to EXTV_{CC}. A differential NPN input stage is biased with internal resistors from an internal 2.4V source as shown in the Functional Diagram. This requires that current either be sourced or sunk from the SENSE pins depending on the output voltage. If the output voltage is below 2.4V current will flow out of both SENSE pins to the main output. The output can be easily preloaded by the V_{OUT} resistive divider to compensate for the current comparator's negative input bias current. The maximum current flowing out of each pair of SENSE pins is:

$$I_{\text{SENSE}^+} + I_{\text{SENSE}^-} = (2.4V - V_{\text{OUT}})/24k$$

Since V_{EAIN} is servoed to the 0.8V reference voltage, we can choose R1 in Figure 8 to have a maximum value to absorb this current.

$$R1_{(\text{MAX})} = 24k \left(\frac{0.8V}{2.4V - V_{\text{OUT}}} \right)$$

for V_{OUT} < 2.4V

Regulating an output voltage of 1.8V, the maximum value of R1 should be 32K. Note that for an output voltage above 2.4V, R1 has no maximum value necessary to absorb the sense currents; however, R1 is still bounded by the V_{EAIN} feedback current.

Soft-Start/Run Function

The RUN/SS1 and RUN/SS2 pins are multipurpose pins that provide a soft-start function and a means to shut down the LTC1708. Soft-start reduces the input power source's surge currents by gradually increasing the controller's current limit (proportional to V_{ITH}). This pin can also be used for power supply sequencing.

An internal 1.2μA current source charges up the C_{SS} capacitor. When the voltage on RUN/SS1 (RUN/SS2) reaches 1.5V, the particular controller is permitted to start operating. As the voltage on RUN/SS increases from 1.5V to 3.0V, the internal current limit is increased from 25mV/R_{SENSE} to 75mV/R_{SENSE}. The output current limit ramps up slowly, taking an additional 1.25s/μF to reach full current. The output current thus ramps up slowly, reducing the starting surge current required from the input power supply. If RUN/SS has been pulled all the way to ground there is a delay before starting of approximately:

$$t_{\text{DELAY}} = \frac{1.5V}{1.2\mu A} C_{\text{SS}} = (1.25s / \mu F) C_{\text{SS}}$$

$$t_{\text{IRAMP}} = \frac{3V - 1.5V}{1.2\mu A} C_{\text{SS}} = (1.25s / \mu F) C_{\text{SS}}$$

By pulling both RUN/SS pins below 1V and/or pulling the STBYMD pin below 0.2V, the LTC1708 is put into low current shutdown (I_Q = 20μA). The RUN/SS pins can be driven directly from logic as shown in Figure 8. Diode D1 in Figure 8 reduces the start delay but allows C_{SS} to ramp up slowly providing the soft-start function. Each RUN/SS pin has an internal 6V zener clamp (See Functional Diagram).

APPLICATIONS INFORMATION

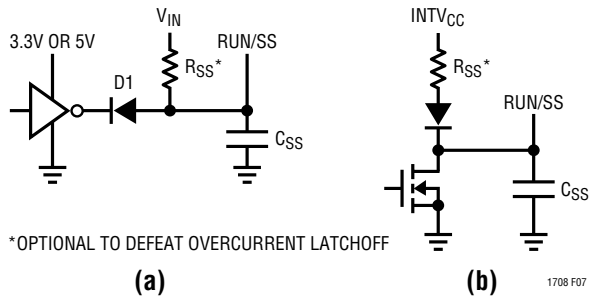

Figure 8. RUN/SS Pin Interfacing

Fault Conditions: Overcurrent Latchoff

The RUN/SS pins also provide the ability to latch off the controller(s) when an overcurrent condition is detected. The RUN/SS capacitor, C_{SS} , is used initially to turn on and limit the inrush current. After the controller has been started and been given adequate time to charge up the output capacitor and provide full load current, the RUN/SS capacitor is used for a short-circuit timer. If the regulator's output voltage falls to less than 70% of its nominal value after C_{SS} reaches 4.1V, C_{SS} begins discharging on the assumption that the output is in an overcurrent condition. If the condition lasts for a long enough period as determined by the size of the C_{SS} and the specified discharge current, the controller will be shut down until the RUN/SS pin voltage is recycled. If the overload occurs during start-up, the time can be approximated by:

$$t_{L01} \approx [C_{SS}(4.1 - 1.5 + 4.1 - 3.5)] / (1.2\mu A) \\ = 2.7 \cdot 10^6 (C_{SS})$$

If the overload occurs after start-up the voltage on C_{SS} will begin discharging from the zener clamp voltage:

$$t_{L02} \approx [C_{SS}(6 - 3.5)] / (1.2\mu A) = 2.1 \cdot 10^6 (C_{SS})$$

This built-in overcurrent latchoff can be overridden by providing a pull-up resistor to the RUN/SS pin as shown in Figure 8. This resistance shortens the soft-start period and prevents the discharge of the RUN/SS capacitor during an over current condition. Tying this pull-up resistor to V_{IN} as in Figure 8a, defeats overcurrent latchoff. Diode-connecting this pull-up resistor to $INTV_{CC}$, as in Figure 8b, eliminates any extra supply current during controller shutdown while eliminating the $INTV_{CC}$ loading from preventing controller start-up.

Why should you defeat overcurrent latchoff? During the prototyping stage of a design, there may be a problem with noise pickup or poor layout causing the protection circuit to latch off. Defeating this feature will easily allow troubleshooting of the circuit and PCB layout. The internal short-circuit and foldback current limiting still remains active, thereby protecting the power supply system from failure. After the design is complete, a decision can be made whether to enable the latchoff feature.

The value of the soft-start capacitor C_{SS} may need to be scaled with output voltage, output capacitance and load current characteristics. The minimum soft-start capacitance is given by:

$$C_{SS} > (C_{OUT})(V_{OUT})(10^{-4})(R_{SENSE})$$

The minimum recommended soft-start capacitor of $C_{SS} = 0.1\mu F$ will be sufficient for most applications.

Fault Conditions: Current Limit and Current Foldback

The LTC1708 current comparator has a maximum sense voltage of 75mV resulting in a maximum MOSFET current of $75mV/R_{SENSE}$. The maximum value of current limit generally occurs with the largest V_{IN} at the highest ambient temperature, conditions that cause the highest power dissipation in the top MOSFET.

The LTC1708 includes current foldback to help further limit load current when the output is shorted to ground. The foldback circuit is active even when the overload shutdown latch described above is overridden. If the output falls below 70% of its nominal output level, then the maximum sense voltage is progressively lowered from 75mV to 25mV. Under short-circuit conditions with very low duty cycles, the LTC1708 will begin cycle skipping in order to limit the short-circuit current. In this situation the bottom MOSFET will be dissipating most of the power but less than in normal operation. The short-circuit ripple current is determined by the minimum on-time $t_{ON(MIN)}$ of the LTC1708 (less than 200ns), the input voltage and inductor value:

$$\Delta I_{L(SC)} = t_{ON(MIN)} (V_{IN}/L)$$

The resulting short-circuit current is:

$$I_{SC} = \frac{25mV}{R_{SENSE}} + \frac{1}{2} \Delta I_{L(SC)}$$

APPLICATIONS INFORMATION

Fault Conditions: Overvoltage Protection (Crowbar)

The overvoltage crowbar is designed to blow a system input fuse when the output voltage of the regulator rises much higher than nominal levels. The crowbar causes huge currents to flow, that blow the fuse to protect against a shorted top MOSFET if the short occurs while the controller is operating.

A comparator monitors the output for overvoltage conditions. The comparator (OV) detects overvoltage faults greater than 7.5% above the nominal output voltage. When this condition is sensed, the top MOSFET is turned off and the bottom MOSFET is turned on until the overvoltage condition is cleared. The output of this comparator is only latched by the overvoltage condition itself and will therefore allow a switching regulator system having a poor PC layout to function while the design is being debugged. The bottom MOSFET remains on continuously for as long as the OV condition persists; if V_{OUT} returns to a safe level, normal operation automatically resumes. A shorted top MOSFET will result in a high current condition which will open the system fuse. The switching regulator will regulate properly with a leaky top MOSFET by altering the duty cycle to accommodate the leakage.

The Standby Mode (STBYMD) Pin Function

The Standby Mode (STBYMD) pin provides several choices for start-up and standby operational modes. If the pin is pulled to ground, the RUN/SS pins for both controllers are internally pulled to ground, preventing start-up and thereby providing a single control pin for turning off both controllers at once. If the pin is left open or decoupled with a capacitor to ground, the RUN/SS pins are each internally provided with a starting current enabling external control for turning on each controller independently. If the pin is provided with a current of $>3\mu\text{A}$ at a voltage greater than 2V, both internal linear regulators (INTV_{CC} and 3.3V) will be on even when both controllers are shut down. In this mode, the onboard 3.3V and 5V linear regulators can provide power to keep-alive functions such as a keyboard controller. This pin can also be used as a latching “on” and/or latching “off” power switch if so designed.

Frequency of Operation

The LTC1708 has an internal voltage controlled oscillator. The frequency of this oscillator can be varied over a 2 to 1 range. The pin is internally self-biased at 1.19V, resulting in a free-running frequency of approximately 220kHz. The FREQSET pin can be grounded to lower this frequency to approximately 140kHz or tied to the INTV_{CC} pin to yield approximately 310kHz. The FREQSET pin may be driven with a voltage from 0 to INTV_{CC} to fix or modulate the oscillator frequency as shown in Figure 5.

Minimum On-Time Considerations

Minimum on-time $t_{ON(MIN)}$ is the smallest time duration that the LTC1708 is capable of turning on the top MOSFET. It is determined by internal timing delays and the gate charge required to turn on the top MOSFET. Low duty cycle applications may approach this minimum on-time limit and care should be taken to ensure that

$$t_{ON(MIN)} < \frac{V_{OUT}}{V_{IN}(f)}$$

If the duty cycle falls below what can be accommodated by the minimum on-time, the LTC1708 will begin to skip cycles. The output voltage will continue to be regulated, but the ripple voltage and current will increase.

The minimum on-time for the LTC1708 is generally less than 200ns. However, as the peak sense voltage decreases the minimum on-time gradually increases up to about 300ns. This is of particular concern in forced continuous applications with low ripple current at light loads. If the duty cycle drops below the minimum on-time limit in this situation, a significant amount of cycle skipping can occur with correspondingly larger current and voltage ripple.

FCB Pin Operation

The FCB pin can be used to regulate a secondary winding or as a logic level input. Continuous operation is forced when the FCB pin drops below 0.8V. During continuous mode, current flows continuously in the transformer primary. The secondary winding(s) draw current only when the bottom, synchronous switch is on. When primary load

APPLICATIONS INFORMATION

currents are low and/or the V_{IN}/V_{OUT} ratio is low, the synchronous switch may not be on for a sufficient amount of time to transfer power from the output capacitor to the secondary load. Forced continuous operation will support secondary windings providing there is sufficient synchronous switch duty factor. Thus, the FCB input pin removes the requirement that power must be drawn from the inductor primary in order to extract power from the auxiliary windings. With the loop in continuous mode, the auxiliary outputs may nominally be loaded without regard to the primary output load.

The secondary output voltage V_{SEC} is normally set as shown in Figure 6a by the turns ratio N of the transformer:

$$V_{SEC} \cong (N + 1) V_{OUT}$$

However, if the controller goes into Burst Mode operation and halts switching due to a light primary load current, then V_{SEC} will droop. An external resistive divider from V_{SEC} to the FCB pin sets a minimum voltage $V_{SEC(MIN)}$:

$$V_{SEC(MIN)} \approx 0.8V \left(1 + \frac{R_6}{R_5} \right)$$

If V_{SEC} drops below this level, the FCB voltage forces temporary continuous switching operation until V_{SEC} is again above its minimum.

In order to prevent erratic operation if no external connections are made to the FCB pin, the FCB pin has a $0.18\mu A$ internal current source pulling the pin high. Include this current when choosing resistor values R_5 and R_6 .

The following table summarizes the possible states available on the FCB pin:

Table 2

| FCB Pin | Condition |
|--------------------------|--|
| 0V to 0.75V | Forced Continuous (Current Reversal Allowed—Burst Inhibited) |
| $0.85V < V_{FCB} < 4.3V$ | Minimum Peak Current Induces Burst Mode Operation No Current Reversal Allowed |
| Feedback Resistors | Regulating a Secondary Winding |
| $>4.8V$ | Burst Mode Operation Disabled Constant Frequency Mode Enabled No Current Reversal Allowed No Minimum Peak Current |

Voltage Positioning

Voltage positioning can be used to minimize peak-to-peak output voltage excursion under worst-case transient loading conditions. The open-loop DC gain of the control loop is reduced depending upon the maximum load step specifications. Voltage positioning can easily be added to the LTC1708 by loading the I_{TH} pin with a resistive divider having a Thevenin equivalent voltage source equal to the midpoint operating voltage of the error amplifier, or $1.2V$ (see Figure 9).

The resistive load reduces the DC loop gain while maintaining the linear control range of the error amplifier. The worst-case peak-to-peak output voltage deviation due to transient loading can theoretically be reduced to half or alternatively the amount of output capacitance can be reduced for a particular application. A complete explanation is included in Design Solutions 10 or the LTC1736 data sheet. (See www.linear.com)

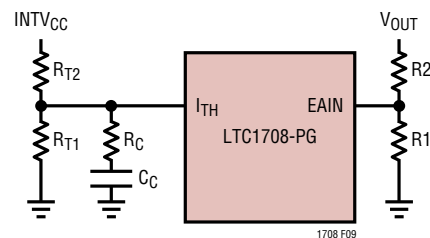

Figure 9. Active Voltage Positioning Applied to the LTC1708

Efficiency Considerations

The percent efficiency of a switching regulator is equal to the output power divided by the input power times 100%. It is often useful to analyze individual losses to determine what is limiting the efficiency and which change would produce the most improvement. Percent efficiency can be expressed as:

$$\% \text{Efficiency} = 100\% - (L_1 + L_2 + L_3 + \dots)$$

where L_1 , L_2 , etc. are the individual losses as a percentage of input power.

Although all dissipative elements in the circuit produce losses, four main sources usually account for most of the losses in LTC1708 circuits: 1) LTC1708 V_{IN} current (including loading on the 3.3V internal regulator), 2) $INTV_{CC}$

APPLICATIONS INFORMATION

regulator current, 3) I^2R losses, 4) Topside MOSFET transition losses.

1. The V_{IN} current has two components: the first is the DC supply current given in the Electrical Characteristics table, which excludes MOSFET driver and control currents; the second is the current drawn from the 3.3V linear regulator output. V_{IN} current typically results in a small (<0.1%) loss.

2. $INTV_{CC}$ current is the sum of the MOSFET driver and control currents. The MOSFET driver current results from switching the gate capacitance of the power MOSFETs. Each time a MOSFET gate is switched from low to high to low again, a packet of charge dQ moves from $INTV_{CC}$ to ground. The resulting dQ/dt is a current out of $INTV_{CC}$ that is typically much larger than the control circuit current. In continuous mode, $I_{GATECHG} = f(Q_T + Q_B)$, where Q_T and Q_B are the gate charges of the topside and bottom side MOSFETs.

Supplying $INTV_{CC}$ power through the $EXTV_{CC}$ switch input from an output-derived source will scale the V_{IN} current required for the driver and control circuits by a factor of (Duty Cycle)/(Efficiency). For example, in a 20V to 5V application, 10mA of $INTV_{CC}$ current results in approximately 2.5mA of V_{IN} current. This reduces the mid-current loss from 10% or more (if the driver was powered directly from V_{IN}) to only a few percent.

3. I^2R losses are predicted from the DC resistances of the fuse (if used), MOSFET, inductor, current sense resistor, and input and output capacitor ESR. In continuous mode the average output current flows through L and R_{SENSE} , but is “chopped” between the topside MOSFET and the synchronous MOSFET. If the two MOSFETs have approximately the same $R_{DS(ON)}$, then the resistance of one MOSFET can simply be summed with the resistances of L , R_{SENSE} and ESR to obtain I^2R losses. For example, if each $R_{DS(ON)} = 10m\Omega$, $R_L = 5m\Omega$, $R_{SENSE} = 3m\Omega$ and $R_{ESR} = 10m\Omega$ (sum of both input and output capacitance losses), then the total resistance is 28m Ω . This results in losses ranging from 3% to 8% as the output current increases from 5A to 15A for a 5V output, or an 8% to 20% loss for a 1.6V output. Efficiency varies as the inverse square of V_{OUT} for the same external components and output power level. The combined effects of increasingly lower output voltages and higher currents required by

high performance digital systems is not doubling but quadrupling the importance of loss terms in the switching regulator system!

4. Transition losses apply only to the topside MOSFET(s), and become significant only when operating at high input voltages (typically 15V or greater). Transition losses can be estimated from:

$$\text{Transition Loss} = (1.7) V_{IN}^2 I_{O(MAX)} C_{RSS} f$$

Other “hidden” losses such as copper trace and internal battery resistances can account for an additional 5% to 10% efficiency degradation in portable systems. It is very important to include these “system” level losses during the design phase. The internal battery and fuse resistance losses can be minimized by making sure that C_{IN} has adequate charge storage and very low ESR at the switching frequency. A 25W supply will typically require a minimum of 20 μ F to 40 μ F of capacitance having a maximum of 20m Ω to 50m Ω of ESR. The LTC1708 2-phase architecture typically halves this input capacitance requirement over competing solutions. Other losses including Schottky conduction losses during dead-time and inductor core losses generally account for less than 2% total additional loss.

Checking Transient Response

The regulator loop response can be checked by looking at the load current transient response. Switching regulators take several cycles to respond to a step in DC (resistive) load current. When a load step occurs, V_{OUT} shifts by an amount equal to ΔI_{LOAD} (ESR), where ESR is the effective series resistance of C_{OUT} . ΔI_{LOAD} also begins to charge or discharge C_{OUT} generating the feedback error signal that forces the regulator to adapt to the current change and return V_{OUT} to its steady-state value. During this recovery time V_{OUT} can be monitored for excessive overshoot or ringing, which would indicate a stability problem. OPTI-LOOP compensation allows the transient response to be optimized over a wide range of output capacitance and ESR values. *The availability of the I_{TH} pin not only allows optimization of control loop behavior but also provides a DC coupled and AC filtered closed loop response test point. The DC step, rise time and settling at this test point truly reflects the closed loop response.* Assuming a

APPLICATIONS INFORMATION

predominantly second order system, phase margin and/or damping factor can be estimated using the percentage of overshoot seen at this pin. The bandwidth can also be estimated by examining the rise time at the pin. The I_{TH} external components shown in the Figure 1 circuit will provide an adequate starting point for most applications.

The I_{TH} series R_C - C_C filter sets the dominant pole-zero loop compensation. The values can be modified slightly (from 0.5 to 2 times their suggested values) to optimize transient response once the final PC layout is done and the particular output capacitor type and value have been determined. The output capacitors need to be selected because the various types and values determine the loop gain and phase. An output current pulse of 20% to 100% of full-load current having a rise time of $1\mu\text{s}$ to $10\mu\text{s}$ will produce output voltage and I_{TH} pin waveforms that will give a sense of the overall loop stability without breaking the feedback loop. The initial output voltage step resulting from the step change in output current may not be within the bandwidth of the feedback loop, so this signal cannot be used to determine phase margin. This is why it is better to look at the I_{TH} pin signal which is in the feedback loop and is the filtered and compensated control loop response. The gain of the loop will be increased by increasing R_C and the bandwidth of the loop will be increased by decreasing C_C . If R_C is increased by the same factor that C_C is decreased, the zero frequency will be kept the same, thereby keeping the phase the same in the most critical frequency range of the feedback loop. The output voltage settling behavior is related to the stability of the closed-loop system and will demonstrate the actual overall supply performance.

A second, more severe transient is caused by switching in loads with large ($>1\mu\text{F}$) supply bypass capacitors. The discharged bypass capacitors are effectively put in parallel with C_{OUT} , causing a rapid drop in V_{OUT} . No regulator can alter its delivery of current quickly enough to prevent this sudden step change in output voltage if the load switch resistance is low and it is driven quickly. If the ratio of C_{LOAD} to C_{OUT} is greater than 1:50, the switch rise time should be controlled so that the load rise time is limited to approximately $25 \cdot C_{LOAD}$. Thus a $10\mu\text{F}$ capacitor would

require a $250\mu\text{s}$ rise time, limiting the charging current to about 200mA.

Automotive Considerations: Plugging into the Cigarette Lighter

As battery-powered devices go mobile, there is a natural interest in plugging into the cigarette lighter in order to conserve or even recharge battery packs during operation. But before you connect, be advised: you are plugging into the supply from hell. The main power line in an automobile is the source of a number of nasty potential transients, including load-dump, reverse-battery and double-battery.

Load-dump is the result of a loose battery cable. When the cable breaks connection, the field collapse in the alternator can cause a positive spike as high as 60V which takes several hundred milliseconds to decay. Reverse-battery is just what it says, while double-battery is a consequence of tow-truck operators finding that a 24V jump start cranks cold engines faster than 12V.

The network shown in Figure 10 is the most straight forward approach to protect a DC/DC converter from the ravages of an automotive power line. The series diode prevents current from flowing during reverse-battery, while the transient suppressor clamps the input voltage during load-dump. Note that the transient suppressor should not conduct during double-battery operation, but must still clamp the input voltage below breakdown of the converter. Although the LTC1708 has a maximum input voltage of 36V, most applications will be limited to 30V by the MOSFET BVDSS.

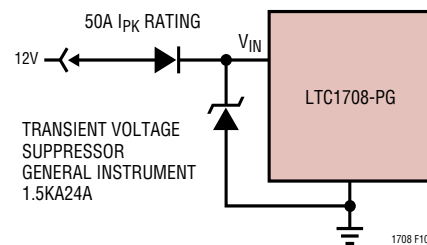

Figure 10. Automotive Application Protection

APPLICATIONS INFORMATION

Design Example

As a design example for one channel, assume $V_{IN} = 12V$ (nominal), $V_{IN} = 22V$ (max), $V_{OUT} = 1.6V$, $I_{MAX} = 14A$, and $f = 300kHz$, R_{SENSE} can immediately be calculated:

$$R_{SENSE} = 50mV/14A \approx 0.0035\Omega \rightarrow 0.003\Omega$$

Tie the FREQSET pin to the INTV_{CC} pin for 300kHz operation, or use a resistive divider from INTV_{CC} according to Figure 5 to reduce the operating frequency.

Assume a 1 μ H inductor and check the actual value of the ripple current. The following equation is used:

$$\Delta I_L = \frac{V_{OUT}}{(f)(L)} \left(1 - \frac{V_{OUT}}{V_{IN}} \right)$$

The highest value of the ripple current occurs at the maximum input voltage:

$$\Delta I_L = \frac{1.6V}{300kHz(1\mu H)} \left(1 - \frac{1.6V}{22V} \right) = 4.95A$$

The ripple current is 35% of maximum output current.

Increasing the ripple current will also help ensure that the minimum on-time of 200ns is not violated. The minimum on-time occurs at maximum V_{IN} :

$$t_{ON(MIN)} = \frac{V_{OUT}}{V_{IN(MAX)}f} = \frac{1.6V}{22V(300kHz)} = 242ns$$

Since the output voltage is below 2.4V the output resistive divider will need to be sized to not only set the output voltage but also to absorb the SENSE pins current.

$$\begin{aligned} R1_{(MAX)} &= 24k \left(\frac{0.8V}{2.4V - V_{OUT}} \right) \\ &= 24k \left(\frac{0.8V}{2.4V - 1.6V} \right) = 24k \end{aligned}$$

Choosing 1% resistors; $R1 = R2 = 20k$ yields an output voltage of 1.600V. If the VID section of the LTC1708-PG is used, $R1$ will range from a value of 6.6k to 64k. If the forced continuous mode is not selected and the programmed

voltage is less than 1.4V with no external load, it is necessary to preload the output in order to prevent the current comparator input bias current from causing the output voltage to rise above the designed level. A 16k preload resistor will prevent this from happening for all programmed output voltages down to the minimum 0.925V level.

The top driver output resistance at the MOSFET threshold is approximately 4 Ω . The power dissipation on the topside MOSFET can be easily estimated. Choosing a International Rectifier IRF7809/IRF7811 combination results in; $R_{DS(ON)} = 0.012\Omega$, $C_{MILLER} = 4nC/16V = 250pF$. At maximum input voltage with T (estimated) = 50°C:

$$\begin{aligned} P_{MAIN} &= \frac{1.6V}{22V} (14)^2 \left[1 + (0.005)(50^\circ C - 25^\circ C) \right] \\ &\quad (0.012\Omega) + (22)^2 \left(\frac{14A}{2} \right) (4\Omega) (250pF) (300kHz) \\ &= 1.2W \end{aligned}$$

A short-circuit to ground will result in a folded back current of:

$$I_{SC} = \frac{25mV}{0.003\Omega} + \frac{1}{2} \left(\frac{200ns(22V)}{1\mu H} \right) = 10.5A$$

with a typical value of $R_{DS(ON)}$ and $\delta = (0.005/^\circ C)(20) = 0.1$ for an IRF7809. The resulting power dissipated in the bottom MOSFET is:

$$\begin{aligned} P_{SYNC} &= \frac{22V - 1.6V}{22V} (10.5A)^2 (1.1)(0.009\Omega) \\ &= 1W \end{aligned}$$

which is less than full-load conditions.

C_{IN} is chosen for an RMS current rating of at least 5A at temperature assuming only this channel is on. C_{OUT} is chosen with an ESR of 0.01 Ω for low output ripple. The output ripple in continuous mode will be highest at the maximum input voltage. The output voltage ripple due to ESR is approximately:

$$V_{ORIPPLE} = R_{ESR}(\Delta I_L) = 0.01\Omega(4.95A) = 50mV_{P-P}$$

APPLICATIONS INFORMATION

PC Board Layout Checklist

When laying out the printed circuit board, the following checklist should be used to ensure proper operation of the LTC1708. These items are also illustrated graphically in the layout diagram of Figure 11. The Figure 12 illustrates the current waveforms present in the various branches of the 2-phase synchronous regulators operating in the continuous mode. Check the following in your layout:

1. Are the top N-channel MOSFETs M1 and M3 located within 1cm of each other with a common drain connection

at C_{IN} ? Do not attempt to split the input decoupling for the two channels as it can cause a large resonant loop.

2. Are the signal and power grounds kept separate? The combined LTC1708 signal ground pin and the ground return of C_{INTVCC} must return to the combined $C_{OUT}(-)$ terminals. The path formed by the top N-channel MOSFET, Schottky diode and the C_{IN} capacitor should have short leads and PC trace lengths. The output capacitor $(-)$ terminals should be connected as close as possible to the $(-)$ terminals of the input capacitor by placing the

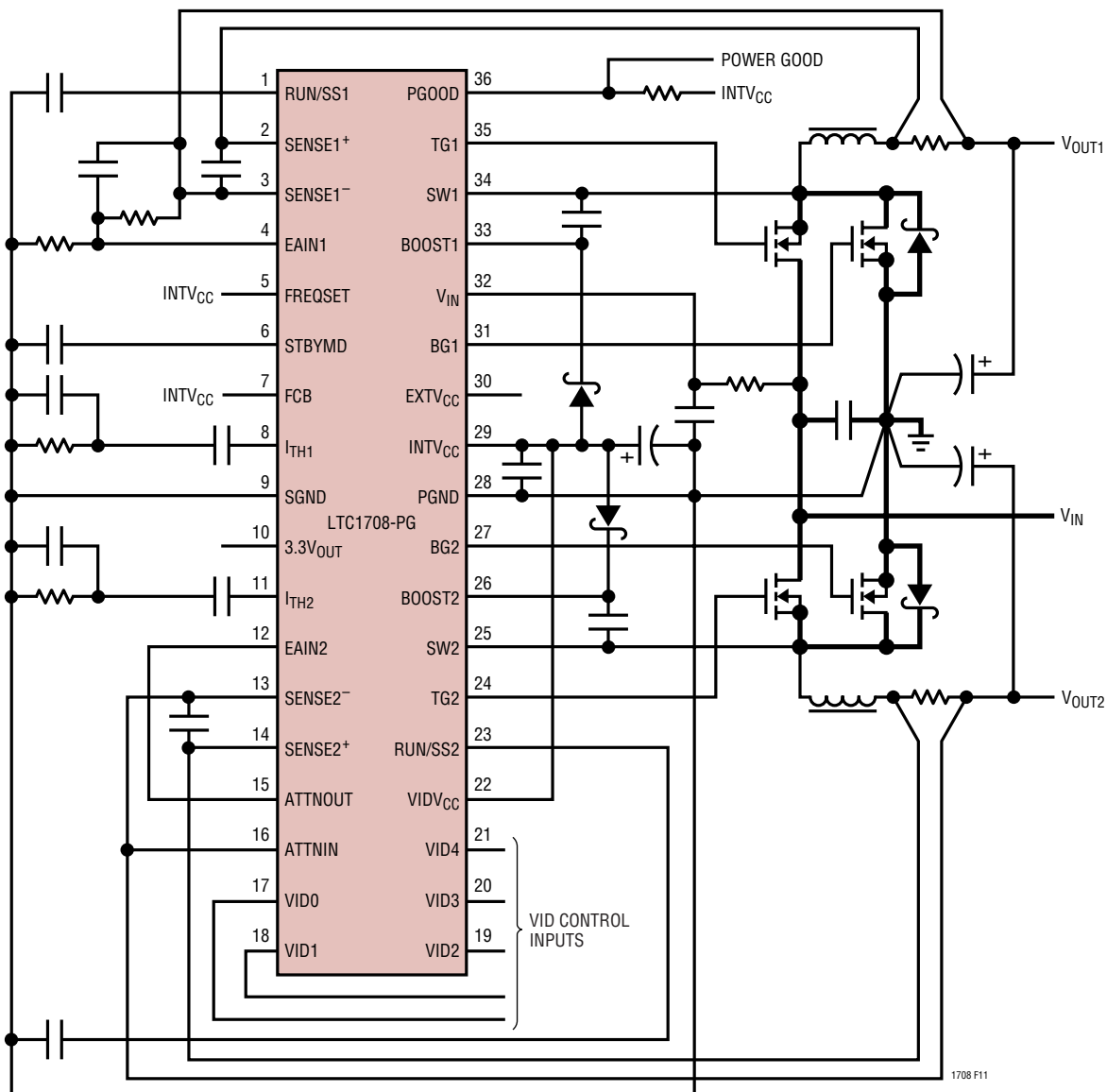

Figure 11. LTC1708 Recommended Printed Circuit Layout Diagram

APPLICATIONS INFORMATION

capacitors next to each other and away from the Schottky loop described above.

3. Do the LTC1708 feedback resistive dividers connect to the (+) terminals of C_{OUT} ? The resistive divider must be connected between the (+) terminal of C_{OUT} and signal ground. The R2 (Figure 8) connection should not be along the high current input feeds from the input capacitor(s).

4. Are the $SENSE^-$ and $SENSE^+$ leads routed together with minimum PC trace spacing? The filter capacitor between $SENSE^+$ and $SENSE^-$ should be as close as possible to the IC. Ensure accurate current sensing with Kelvin connections.

5. Is the $INTV_{CC}$ decoupling capacitor connected close to the IC, between the $INTV_{CC}$ and the power ground pins? This capacitor carries the MOSFET drivers current peaks. An additional $1\mu\text{F}$ ceramic capacitor placed immediately next to the $INTV_{CC}$ and PGND pins can help improve noise performance substantially.

6. Keep the switching nodes (SW1, SW2), top gate nodes (TG1, TG2), and boost nodes (BOOST1, BOOST2) away from sensitive small-signal nodes, especially from the opposites channel's voltage and current sensing feedback pins. All of these nodes have very large and fast moving signals and therefore should be kept on the "output side" of the LTC1708 and occupy minimum PC trace area.

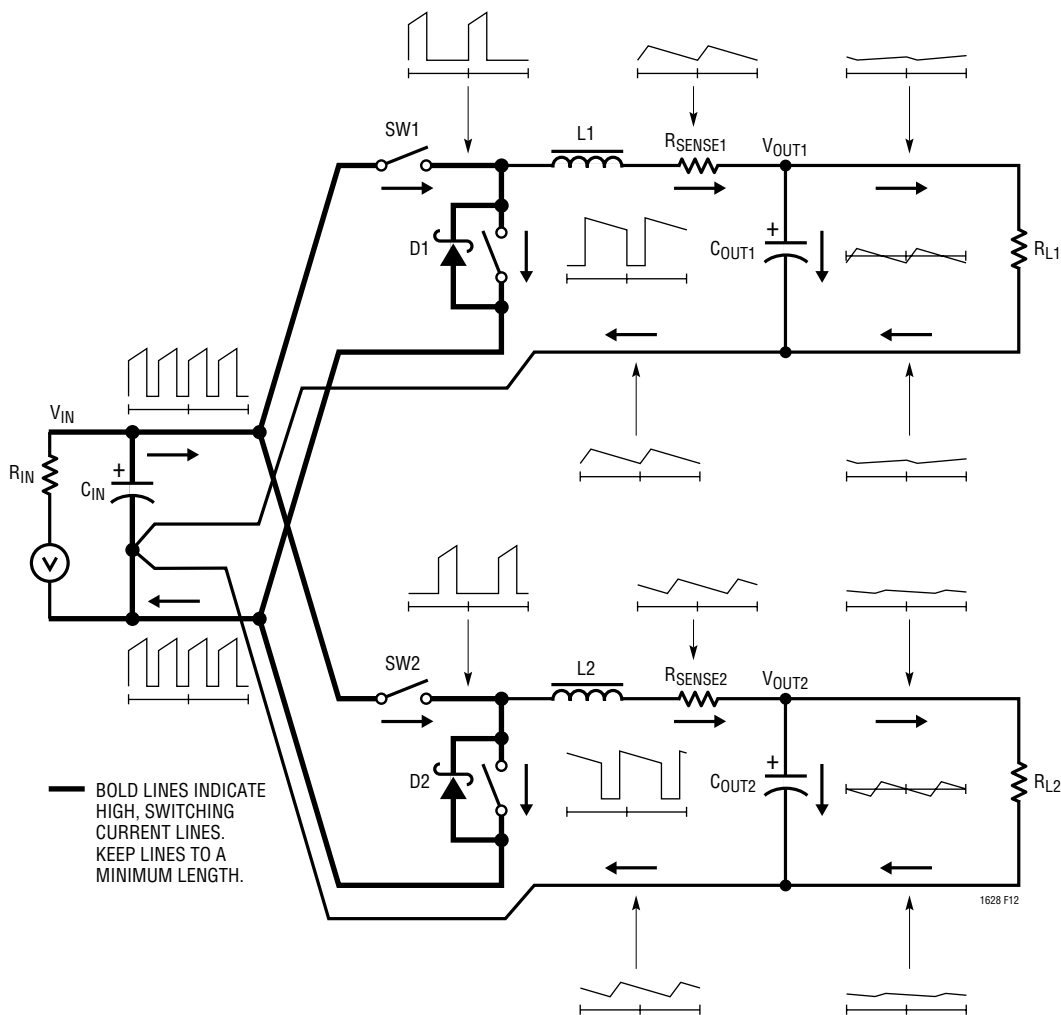

Figure 12. Branch Current Waveforms

APPLICATIONS INFORMATION

7. Use a modified “star ground” technique: a low impedance, large copper area central grounding point on the same side of the PC board as the input and output capacitors with tie-ins for the bottom of the $INTV_{CC}$ decoupling capacitor, the bottom of the voltage feedback resistive divider and the SGND pin of the IC.

PC Board Layout Debugging

Start with one controller on at a time. It is helpful to use a DC-50MHz current probe to monitor the current in the inductor while testing the circuit. Monitor the output switching node (SW pin) to synchronize the oscilloscope to the internal oscillator and probe the actual output voltage as well. Check for proper performance over the operating voltage and current range expected in the application. The frequency of operation should be maintained over the input voltage range down to dropout and until the output load drops below the low current operation threshold—typically 10% to 20% of the maximum designed current level in Burst Mode operation.

The duty cycle percentage should be maintained from cycle to cycle in a well-designed, low noise PCB implementation. Variation in the duty cycle at a subharmonic rate can suggest noise pickup at the current or voltage sensing inputs or inadequate loop compensation. Overcompensation of the loop can be used to tame a poor PC layout if regulator bandwidth optimization is not required. Only after each controller is checked for their individual performance should both controllers be turned on at the same time. A particularly difficult region of operation is when one controller channel is nearing its current comparator trip point when the other channel is turning on its top MOSFET. This occurs around 50% duty cycle on either channel due to the phasing of the internal clocks and may cause minor duty cycle jitter.

Short-circuit testing can be performed to verify proper overcurrent latchoff, or $5\mu\text{A}$ can be provided to the RUN/SS pin(s) by resistors from V_{IN} to prevent the short-circuit latchoff from occurring.

Reduce V_{IN} from its nominal level to verify operation of the regulator in dropout. Check the operation of the undervoltage lockout circuit by further lowering V_{IN} while monitoring the outputs to verify operation.

Investigate whether any problems exist only at higher output currents or only at higher input voltages. If problems coincide with high input voltages and low output currents, look for capacitive coupling between the BOOST, SW, TG, and possibly BG connections and the sensitive voltage and current pins. The capacitor placed across the current sensing pins needs to be placed immediately adjacent to the pins of the IC. This capacitor helps to minimize the effects of differential noise injection due to high frequency capacitive coupling. If problems are encountered with high current output loading at lower input voltages, look for inductive coupling between C_{IN} , Schottky and the top MOSFET components to the sensitive current and voltage sensing traces. In addition, investigate common ground path voltage pickup between these components and the SGND pin of the IC.

An embarrassing problem, which can be missed in an otherwise properly working switching regulator, results when the current sensing leads are hooked up backwards. The output voltage under this improper hookup will still be maintained but the advantages of current mode control will not be realized. Compensation of the voltage loop will be much more sensitive to component selection. This behavior can be investigated by temporarily shorting out the current sensing resistor—don't worry, the regulator will still maintain control of the output voltage.

TYPICAL APPLICATION

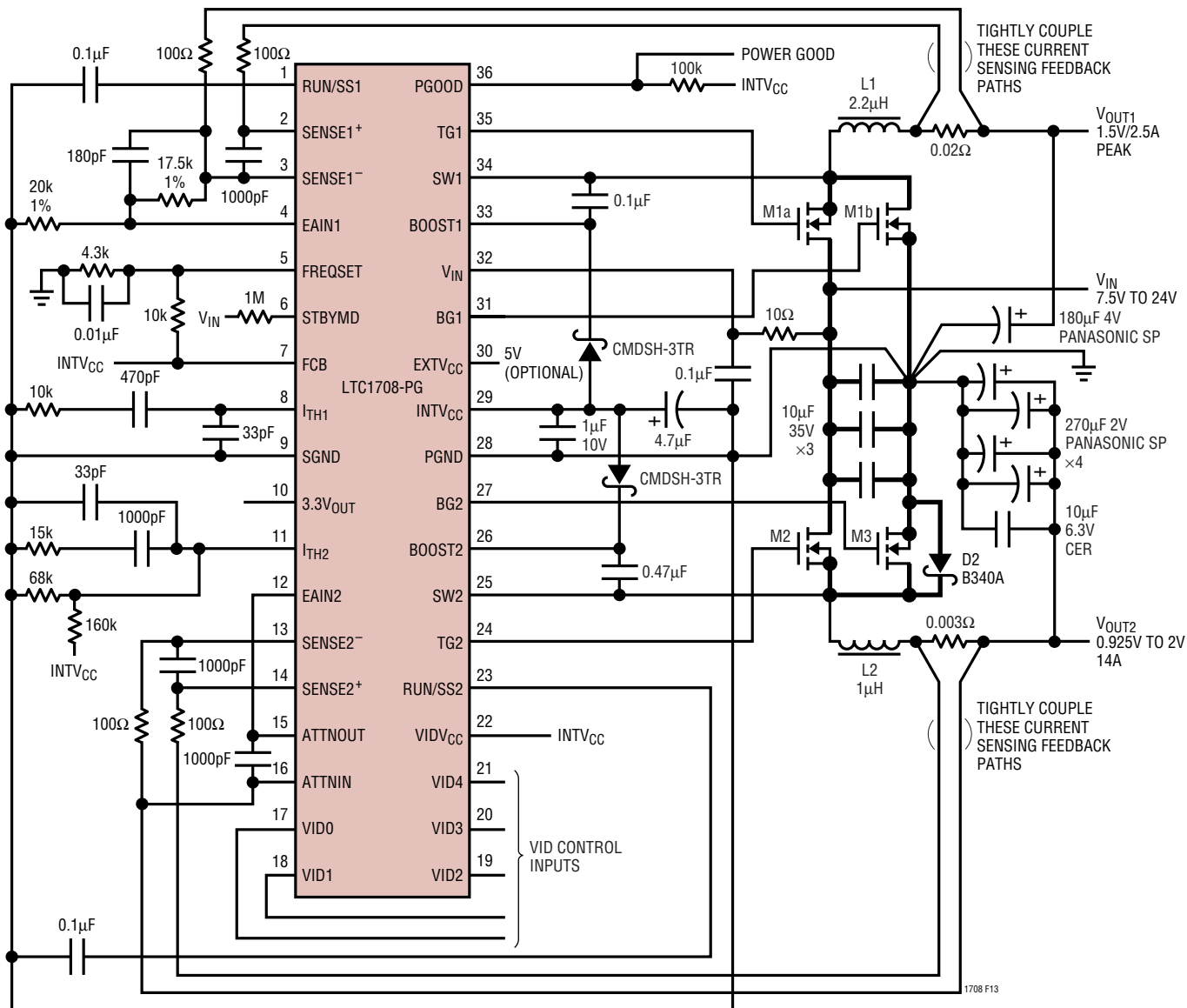

V_{IN}: 12V TO 22V
 V_{OUT1}: 1.5V/2.5A
 V_{OUT2}: 0.925V TO 2V/14A
 SWITCHING FREQUENCY: 250kHz

M1a, M1b: FDS6982S
 M2: IRF7811W
 M3: ZXIRF7811W

L1: 2.2µH
 L2: 1µH

NOTE: ELECTRICAL PATHS DRAWN WITH THICK LINES SHOULD BE KEPT AS SHORT AND WIDE AS POSSIBLE. THESE PATHS WILL RADIATE EMI AT THE SWITCHING FREQUENCY. KEEP THE PATHS' ENCLOSED AREA SMALL.

Figure 13. LTC1708 High Efficiency, Constant Frequency CPU Core/IO Power Supply with Active Voltage Positioning

PACKAGE DESCRIPTION

G Package
36-Lead Plastic SSOP (0.209)
 (LTC DWG # 05-08-1640)

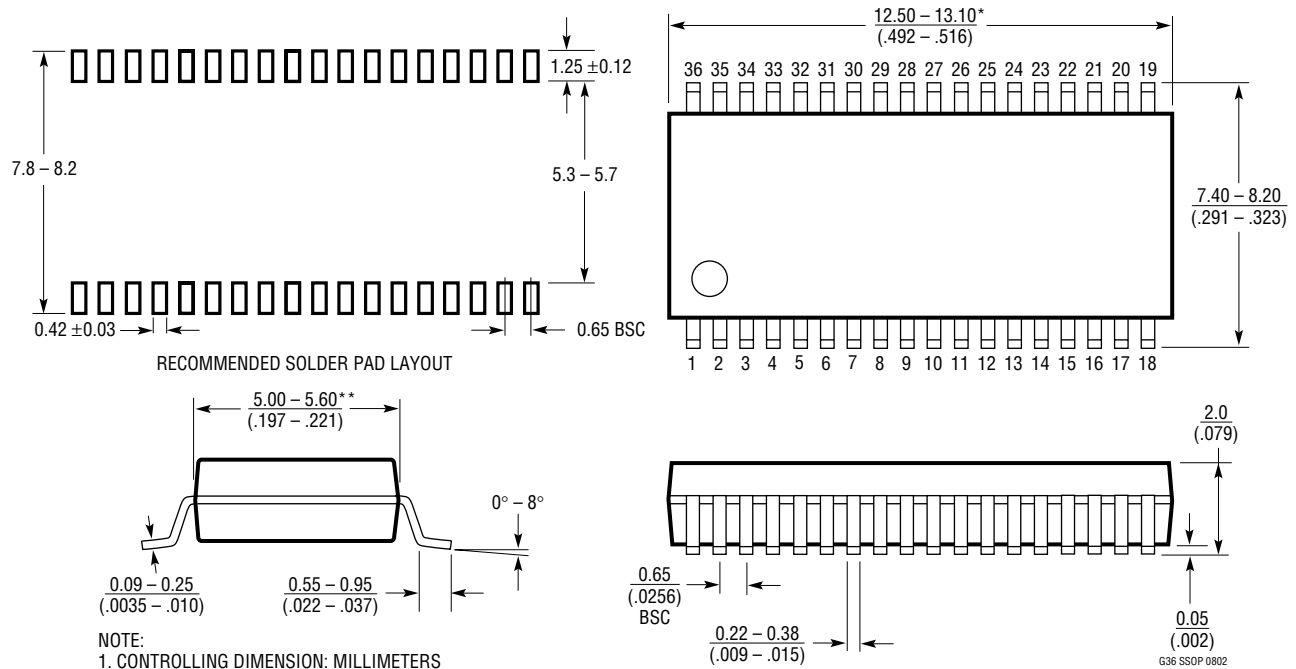

- NOTE:
1. CONTROLLING DIMENSION: MILLIMETERS
 2. DIMENSIONS ARE IN $\frac{\text{MILLIMETERS}}{\text{(INCHES)}}$
 3. DRAWING NOT TO SCALE
- *DIMENSIONS DO NOT INCLUDE MOLD FLASH. MOLD FLASH SHALL NOT EXCEED .152mm (.006") PER SIDE
- **DIMENSIONS DO NOT INCLUDE INTERLEAD FLASH. INTERLEAD FLASH SHALL NOT EXCEED .254mm (.010") PER SIDE

RELATED PARTS

| PART NUMBER | DESCRIPTION | COMMENTS |
|-------------------|--|---|
| LTC1159 | High Efficiency Synchronous Step-Down Switching Regulator Controller | 100% DC, Logic Level MOSFETs, $V_{IN} < 40V$ |
| LTC1430 | High Power Step-Down Synchronous DC/DC Controller in SO-8 | High Efficiency 5V to 3.3V Conversion at Up to 15A |
| LTC1436A-PLL | High Efficiency Low Noise Synchronous Step-Down Switching Regulator | Adaptive Power™ Mode 20-Pin, 24-Pin SSOP |
| LTC1438/LTC1439 | Dual High Efficiency Low Noise Synchronous Step-Down Switching Regulators | POR, Auxiliary Regulator |
| LTC1438-ADJ | Dual Synchronous Controller with Auxiliary Regulator | POR, External Feedback Divider |
| LTC1538-AUX | Dual High Efficiency Low Noise Synchronous Step-Down Switching Regulator | Auxiliary Regulator, 5V Standby |
| LTC1539 | Dual High Efficiency Low Noise Synchronous Step-Down Switching Regulator | 5V Standby, POR, Low-Battery, Aux Regulator |
| LTC1625/LTC1775 | No R_{SENSE} ™ Current Mode Synchronous Step-Down Controller | 97% Efficiency, No Sense Resistor, 16-Pin SSOP |
| LTC1628 | Dual Output, 2-Phase Step-Down Synchronous Current Mode Controller | Optimized Solution Cost, $3.5V \leq V_{IN} \leq 36V$ |
| LTC1629 | 20A to 200A PolyPhase™ Synchronous Current Mode Controller | Expandable from 2-Phase to 12-Phase, Uses All Surface Mount Components, No Heat Sink |
| LTC1702 | No R_{SENSE} 2-Phase Dual Synchronous Step-Down Controller | 550kHz, No Sense Resistor, $V_{IN} \leq 7V$ |
| LTC1703 | No R_{SENSE} 2-Phase Dual Synchronous Step-Down Controller with 5-Bit Mobile VID Control | Mobile Pentium III Processors, 550kHz, $V_{IN} \leq 7V$ |
| LTC1709 | 42A High Efficiency Synchronous Current Mode Controller with 5-Bit Desktop VID Control | Server, Workstation All Surface Mount Solution |
| LTC1735 | High Efficiency Synchronous Step-Down Synchronous Current Mode Controller | Output Fault Protection, 16-Pin SSOP |
| LTC1736 | High Efficiency Synchronous Current Mode Controller with 5-Bit Mobile VID Control | Output Fault Protection, 24-Pin SSOP, Power Good $3.5V \leq V_{IN} \leq 36V$ |
| LTC1778/LTC1778-1 | No R_{SENSE} Current Mode Synchronous Step-Down Controller | Up to 97% Efficiency, $4V \leq V_{IN} \leq 36V$, $0.8V \leq V_{OUT} \leq (0.9)(V_{IN})$, I_{OUT} up to 20A |
| LTC1929 | Single Output, 2-Phase Synchronous Current Mode Controller | Up to 42A, Uses All Surface Mount Components, No Heat Sink |
| LTC1960 | Dual Battery Charger/Selector with SPI Interface | Simultaneous Dual-Battery Discharge Extends Run Time by 10%. Reduces Charging Time by up to 50% |
| LTC3711 | No R_{SENSE} Current Mode Synchronous Step-Down Controller with Digital 5-Bit Interface | Up to 97% Efficiency, Ideal for Pentium III Processors, $0.925V \leq V_{OUT} \leq 2V$, $4V \leq V_{IN} \leq 36V$, I_{OUT} up to 20A |
| LTC3728 | Dual, 550kHz, 2-Phase Synchronous Step-Down Controller | $3.5V \leq V_{IN} \leq 35V$, 99% Duty Cycle, 5mm × 5mm QFN, SSOP-28 |
| LTC3729 | 20A to 200A, 550kHz PolyPhase Synchronous Controller | Expandable from 2-Phase to 12-Phase, Uses all Surface Mount Components, V_{IN} up to 36V, QFN, SSOP-28 |
| LTC3732 | 3-Phase, 5-Bit VID 600kHz Synchronous Buck up to 60A | VRM 9.0, VID, SSOP-36 |

Adaptive Power, No R_{SENSE} and PolyPhase are trademarks of Linear Technology Corporation.