

FEATURES

- 68.5dB SNR
- 90dB SFDR
- Low Power: 347mW/333mW/306mW Total
- Single 1.8V Supply
- DDR LVDS Outputs
- Easy-to-Drive 1.5V_{p-p} Input Range
- 1.25GHz Full Power Bandwidth S/H
- Optional Clock Duty Cycle Stabilizer
- Low Power Sleep and Nap Modes
- Serial SPI Port for Configuration
- Pin-Compatible 14-Bit Versions
- 40-Lead (6mm × 6mm) QFN Package

APPLICATIONS

- Communications
- Cellular Basestations
- Software Defined Radios
- Medical Imaging
- High Definition Video
- Testing and Measurement Instruments

DESCRIPTION

The LTC[®]2152-12/LTC2151-12/LTC2150-12 are a family of 250Mps/210Mps/170Mps 12-bit A/D converters designed for digitizing high frequency, wide dynamic range signals. They are perfect for demanding communications applications with AC performance that includes 68.5dB SNR and 90dB spurious free dynamic range (SFDR). The 1.25GHz input bandwidth allows the ADC to undersample high input frequencies with good performance. The latency is only five clock cycles.

DC specs include $\pm 0.26\text{LSB INL}$ (typ), $\pm 0.16\text{LSB DNL}$ (typ) and no missing codes over temperature. The transition noise is $0.54\text{LSB}_{\text{RMS}}$.

The digital outputs are double-data rate (DDR) LVDS.

The ENC⁺ and ENC⁻ inputs can be driven differentially with a sine wave, PECL, LVDS, TTL, or CMOS inputs. An optional clock duty cycle stabilizer allows high performance at full speed for a wide range of clock duty cycles.

LT, LTC, LTM, Linear Technology and the Linear logo are registered trademarks of Linear Technology Corporation. All other trademarks are the property of their respective owners.

TYPICAL APPLICATION

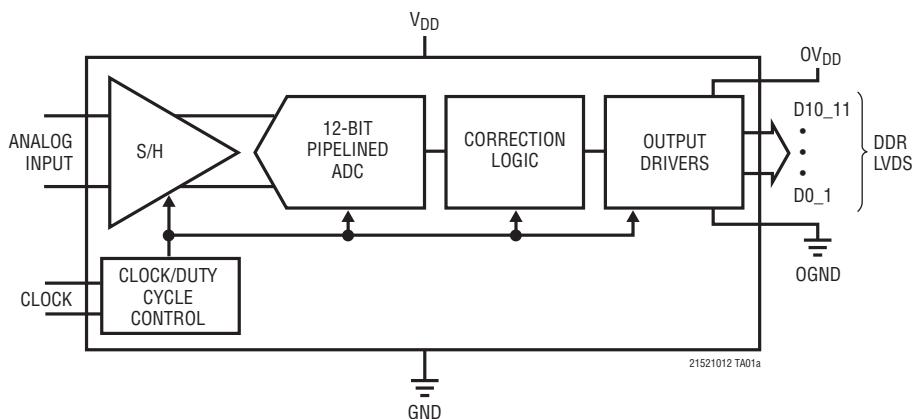

LTC2152-12: 32K Point 2-Tone FFT,
 $f_{\text{IN}} = 71\text{MHz}$ and 69MHz , 250Mps

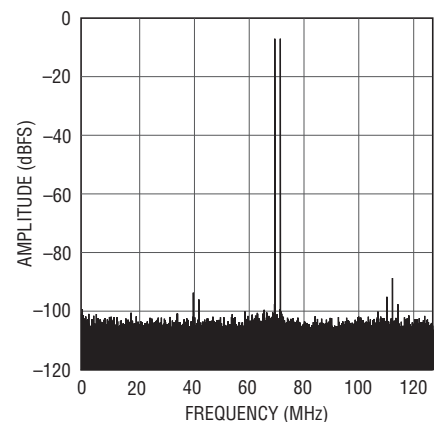

LTC2152-12/ LTC2151-12/LTC2150-12

ABSOLUTE MAXIMUM RATINGS

(Notes 1, 2)

Supply Voltage

V_{DD} , OV_{DD} -0.3V to 2V

Analog Input Voltage

A_{IN}^+ , A_{IN}^- , PAR/SER,

SENSE (Note 3)..... -0.3V to ($V_{DD} + 0.2V$)

Digital Input Voltage

ENC⁺, ENC⁻ (Note 3)..... -0.3V to ($V_{DD} + 0.3V$)

\overline{CS} , SDI, SCK (Note 4)..... -0.3V to 3.9V

SDO (Note 4)..... -0.3V to 3.9V

Digital Output Voltage..... -0.3V to ($OV_{DD} + 0.3V$)

Operating Temperature Range

LTC2152C, LTC2151C, LTC2150C..... 0°C to 70°C

LTC2152I, LTC2151I, LTC2150I -40°C to 85°C

Storage Temperature Range -65°C to 150°C

PIN CONFIGURATION

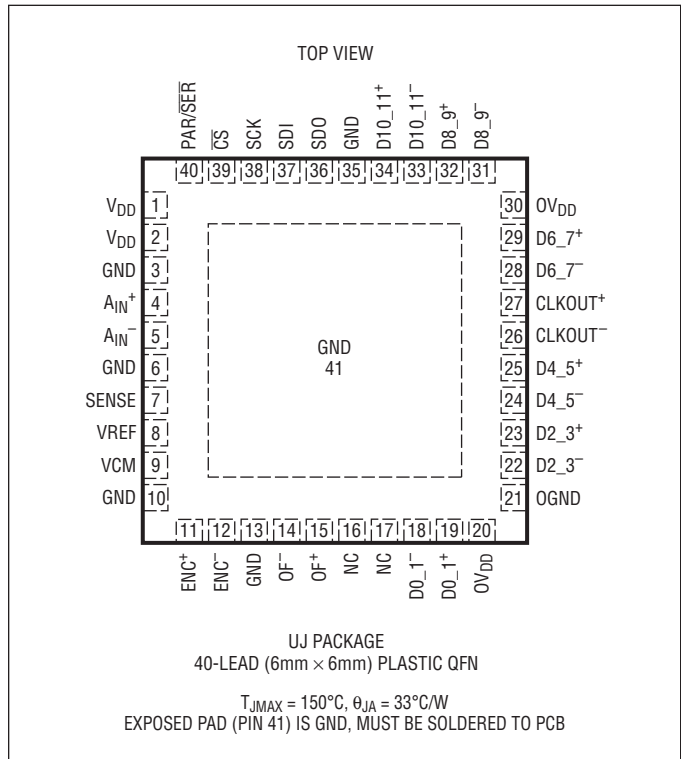

ORDER INFORMATION

LEAD FREE FINISH	TAPE AND REEL	PART MARKING*	PACKAGE DESCRIPTION	TEMPERATURE RANGE
LTC2152CUJ-12#PBF	LTC2152CUJ-12#TRPBF	LTC2152UJ-12	40-Lead (6mm × 6mm) Plastic QFN	0°C to 70°C
LTC2152IUJ-12#PBF	LTC2152IUJ-12#TRPBF	LTC2152UJ-12	40-Lead (6mm × 6mm) Plastic QFN	-40°C to 85°C
LTC2151CUJ-12#PBF	LTC2151CUJ-12#TRPBF	LTC2151UJ-12	40-Lead (6mm × 6mm) Plastic QFN	0°C to 70°C
LTC2151IUJ-12#PBF	LTC2151IUJ-12#TRPBF	LTC2151UJ-12	40-Lead (6mm × 6mm) Plastic QFN	-40°C to 85°C
LTC2150CUJ-12#PBF	LTC2150CUJ-12#TRPBF	LTC2150UJ-12	40-Lead (6mm × 6mm) Plastic QFN	0°C to 70°C
LTC2150IUJ-12#PBF	LTC2150IUJ-12#TRPBF	LTC2150UJ-12	40-Lead (6mm × 6mm) Plastic QFN	-40°C to 85°C

Consult LTC Marketing for parts specified with wider operating temperature ranges. *The temperature grade is identified by a label on the shipping container.

For more information on lead free part marking, go to: <http://www.linear.com/leadfree/>

For more information on tape and reel specifications, go to: <http://www.linear.com/tapeandreeel/>

CONVERTER CHARACTERISTICS The ● denotes the specifications which apply over the full operating temperature range, otherwise specifications are at $T_A = 25^\circ\text{C}$. (Note 5)

PARAMETER	CONDITIONS	LTC2152-12			LTC2151-12			LTC2150-12			UNITS	
		MIN	TYP	MAX	MIN	TYP	MAX	MIN	TYP	MAX		
Resolution (No Missing Codes)		●	12		12		12		12		Bits	
Integral Linearity Error	Differential Analog Input (Note 6)	●	-1.2	±0.26	1.2	-1.2	±0.30	1.2	-1.2	±0.30	1.2	LSB
Differential Linearity Error	Differential Analog Input	●	-0.6	±0.16	0.6	-0.6	±0.16	0.6	-0.6	±0.16	0.6	LSB
Offset Error	(Note 7)	●	-13	±5	13	-13	±5	13	-13	±5	13	mV
Gain Error	External Reference	●	-4	±1	3	-4	±1	3	-4	±1	3	%FS
Offset Drift				±20			±20			±20		μV/°C
Full-Scale Drift	Internal Reference			±30			±30			±30		ppm/°C
	External Reference			±10			±10			±10		ppm/°C
Transition Noise				0.54			0.54			0.54		LSB _{RMS}

ANALOG INPUT The ● denotes the specifications which apply over the full operating temperature range, otherwise specifications are at $T_A = 25^\circ\text{C}$. (Note 5)

SYMBOL	PARAMETER	CONDITIONS	MIN	TYP	MAX	UNITS	
V_{IN}	Analog Input Range ($A_{IN}^+ - A_{IN}^-$)	$1.7V < V_{DD} < 1.9V$		1.5		V_{P-P}	
$V_{IN(CM)}$	Analog Input Common Mode ($A_{IN}^+ + A_{IN}^-$)/2	Differential Analog Input (Note 8)	●	$V_{CM} - 20mV$	V_{CM}	$V_{CM} + 20mV$	V
V_{SENSE}	External Reference Mode	External Reference Mode	●	1.200	1.250	1.300	V
I_{IN1}	Analog Input Leakage Current	$0 < A_{IN}^+, A_{IN}^- < V_{DD}$, No Encode	●	-1	1		μA
I_{IN2}	SENSE Input Leakage Current	$1.2V < SENSE < 1.3V$	●	-1	1		μA
I_{IN3}	PAR/SER Input Leakage Current	$0 < PAR/SER < V_{DD}$	●	-1	1		μA
t_{AP}	Sample-and-Hold Acquisition Delay Time			1			ns
t_{JITTER}	Sample-and-Hold Acquisition Delay Jitter			0.15			ps _{RMS}
CMRR	Analog Input Common Mode Rejection Ratio			75			dB
BW-3B	Full-Power Bandwidth			1250			MHz

DYNAMIC ACCURACY The ● denotes the specifications which apply over the full operating temperature range, otherwise specifications are at $T_A = 25^\circ\text{C}$. $A_{IN} = -1dBFS$. (Note 5)

SYMBOL	PARAMETER	CONDITIONS	LTC2152-12			LTC2151-12			LTC2150-12			UNITS
			MIN	TYP	MAX	MIN	TYP	MAX	MIN	TYP	MAX	
SNR	Signal-to-Noise Ratio	15MHz Input		68.5		68.5		68.5		68.5		dBFS
		70MHz Input		68.4		68.3		68.3		68.3		dBFS
		140MHz Input	●	67.1	68.0	67.1	67.9	67.3	67.8		67.8	
SFDR	Spurious Free Dynamic Range 2nd or 3rd Harmonic	15MHz Input		90.6		90.1		90		90		dBFS
		70MHz Input		88		89		88		88		dBFS
		140MHz Input	●	72	80	74	81	76	80		80	
S/(N+D)	Signal-to-Noise Plus Distortion Ratio	15MHz Input		98		98		98		98		dBFS
		70MHz Input		95		95		95		95		dBFS
		140MHz Input	●	81	85	82	85	83	84		84	
Crosstalk	Crosstalk Between Channels	Up to 315MHz Input		-95		-95		-95		-95		dB

INTERNAL REFERENCE CHARACTERISTICS The ● denotes the specifications which apply over the full operating temperature range, otherwise specifications are at $T_A = 25^\circ\text{C}$. (Note 5)

PARAMETER	CONDITIONS	MIN	TYP	MAX	UNITS
V_{CM} Output Voltage	$I_{OUT} = 0$	0.439 • $V_{DD} - 18\text{mV}$	0.439 • V_{DD}	0.439 • $V_{DD} + 18\text{mV}$	V
V_{CM} Output Temperature Drift			±37		ppm/°C
V_{CM} Output Resistance	$-1\text{mA} < I_{OUT} < 1\text{mA}$		4		Ω
V_{REF} Output Voltage	$I_{OUT} = 0$	1.225	1.250	1.275	V
V_{REF} Output Temperature Drift			±30		ppm/°C
V_{REF} Output Resistance	$-400\mu\text{A} < I_{OUT} < 1\text{mA}$		7		Ω
V_{REF} Line Regulation	$1.7\text{V} < V_{DD} < 1.9\text{V}$		0.6		mV/V

POWER REQUIREMENTS The ● denotes the specifications which apply over the full operating temperature range, otherwise specifications are at $T_A = 25^\circ\text{C}$. (Note 5)

SYMBOL	PARAMETER	CONDITIONS	LTC2152-12			LTC2151-12			LTC2150-12			UNITS	
			MIN	TYP	MAX	MIN	TYP	MAX	MIN	TYP	MAX		
V_{DD}	Analog Supply Voltage	(Note 9)	●	1.7	1.8	1.9	1.7	1.8	1.9	1.7	1.8	1.9	V
OV_{DD}	Output Supply Voltage	LVDS Mode (Note 9)	●	1.7	1.8	1.9	1.7	1.8	1.9	1.7	1.8	1.9	V
I_{VDD}	Analog Supply Current		●	166	185		158	175		145	159		mA
I_{OVDD}	Digital Supply Current	1.75mA LVDS Mode	●	27	32		27	31		25	30		mA
		3.5mA LVDS Mode	●	45	50		44	50		43	48		mA
P_{DISS}	Power Dissipation	1.75mA LVDS Mode	●	347	391		333	371		306	340		mW
		3.5mA LVDS Mode	●	380	423		364	405		338	373		mW
P_{NAP}	Nap Mode Power	Clocked at $f_{S(MAX)}$		105			99			93			mW
P_{SLEEP}	Sleep Mode Power	Clocked at $f_{S(MAX)}$		<2			<2			<2			mW

DIGITAL INPUTS AND OUTPUTS The ● denotes the specifications which apply over the full operating temperature range, otherwise specifications are at $T_A = 25^\circ\text{C}$. (Note 5)

SYMBOL	PARAMETER	CONDITIONS	MIN	TYP	MAX	UNITS	
ENCODE INPUTS (ENC⁺, ENC⁻)							
V_{ID}	Differential Input Voltage	(Note 8)	●	0.2	1	1.9	V
V_{ICM}	Common Mode Input Voltage	Internally Set			1.2		V
		Externally Set (Note 8)	●	1.1		1.5	V
V_{IN}	Input Voltage Range	ENC ⁺ , ENC ⁻ to GND	●	0.2		1.9	V
R_{IN}	Input Resistance	(See Figure 2)			10	kΩ	
C_{IN}	Input Capacitance	(Note 8)			2	pF	
DIGITAL INPUTS (CS, SDI, SCK)							
V_{IH}	High Level Input Voltage	$V_{DD} = 1.8\text{V}$	●	1.3			V
V_{IL}	Low Level Input Voltage	$V_{DD} = 1.8\text{V}$	●			0.6	V
I_{IN}	Input Current	$V_{IN} = 0\text{V}$ to 1.8V	●	-10		10	μA
C_{IN}	Input Capacitance	(Note 8)			3		pF
SDO OUTPUT (Open-Drain Output. Requires 2k Pull-Up Resistor if SDO Is Used)							
R_{OL}	Logic Low Output Resistance to GND	$V_{DD} = 1.8\text{V}$, SDO = 0V			200		Ω
I_{OH}	Logic High Output Leakage Current	SDO = 0V to 3.6V	●	-10		10	μA
C_{OUT}	Output Capacitance	(Note 8)			4		pF

DIGITAL INPUTS AND OUTPUTS The ● denotes the specifications which apply over the full operating temperature range, otherwise specifications are at $T_A = 25^\circ\text{C}$. (Note 5)

SYMBOL	PARAMETER	CONDITIONS		MIN	TYP	MAX	UNITS
DIGITAL DATA OUTPUTS							
V_{OD}	Differential Output Voltage	100 Ω Differential Load, 3.5mA Mode 100 Ω Differential Load, 1.75mA Mode	● ●	247 125	350 175	454 250	mV mV
V_{OS}	Common Mode Output Voltage	100 Ω Differential Load, 3.5mA Mode 100 Ω Differential Load, 1.75mA Mode	● ●	1.125 1.125	1.250 1.250	1.375 1.375	V V
R_{TERM}	On-Chip Termination Resistance	Termination Enabled, $OV_{DD} = 1.8\text{V}$			100		Ω

TIMING CHARACTERISTICS The ● denotes the specifications which apply over the full operating temperature range, otherwise specifications are at $T_A = 25^\circ\text{C}$. (Note 5)

SYMBOL	PARAMETER	CONDITIONS		LTC2152-12			LTC2151-12			LTC2150-12			UNITS
				MIN	TYP	MAX	MIN	TYP	MAX	MIN	TYP	MAX	
f_S	Sampling Frequency	(Note 9)	●	10	250		10	210		10	170		MHz
t_L	ENC Low Time (Note 8)	Duty Cycle Stabilizer Off	●	1.9	2	50	2.26	2.38	50	2.79	2.94	50	ns
		Duty Cycle Stabilizer On	●	1.5	2	50	1.5	2.38	50	1.5	2.94	50	ns
t_H	ENC High Time (Note 8)	Duty Cycle Stabilizer Off	●	1.9	2	50	2.26	2.38	50	2.79	2.94	50	ns
		Duty Cycle Stabilizer On	●	1.5	2	50	1.5	2.38	50	1.5	2.94	50	ns

DIGITAL DATA OUTPUTS

SYMBOL	PARAMETER	CONDITIONS		LTC215X-12			UNITS
				MIN	TYP	MAX	
t_D	ENC to Data Delay	$C_L = 5\text{pF}$	●	1.7	2	2.3	ns
t_C	ENC to CLKOUT Delay	$C_L = 5\text{pF}$	●	1.3	1.6	2	ns
t_{SKEW}	DATA to CLKOUT Skew	$t_D - t_C$	●	0.3	0.4	0.55	ns
	Pipeline Latency			5		5	Cycles

SPI Port Timing (Note 8)

t_{SCK}	SCK Period	Write Mode, $C_{SDO} = 20\text{pF}$		40			ns
		Readback Mode $R_{PULLUP} = 2\text{k}$, $C_{SDO} = 20\text{pF}$		250			ns
t_S	\overline{CS} to SCK Set-Up Time		●	5			ns
t_H	SCK to \overline{CS} Hold Time		●	5			ns
t_{DS}	SDI Set-Up Time		●	5			ns
t_{DH}	SDI Hold Time		●	5			ns
t_{DO}	SCK Falling to SDO Valid	Readback Mode $R_{PULLUP} = 2\text{k}$, $C_{SDO} = 20\text{pF}$	●			125	ns

Note 1: Stresses beyond those listed under Absolute Maximum Ratings may cause permanent damage to the device. Exposure to any Absolute Maximum Rating condition for extended periods may affect device reliability and lifetime.

Note 2: All voltage values are with respect to GND with GND and OGDN shorted (unless otherwise noted).

Note 3: When these pin voltages are taken below GND or above V_{DD} , they will be clamped by internal diodes. This product can handle input currents of greater than 100mA below GND or above V_{DD} without latchup.

Note 4: When these pin voltages are taken below GND they will be clamped by internal diodes. When these pin voltages are taken above V_{DD} they will not be clamped by internal diodes. This product can handle input currents of greater than 100mA below GND without latchup.

Note 5: $V_{DD} = OV_{DD} = 1.8\text{V}$, $f_{SAMPLE} = 250\text{MHz}$ (LTC2152), 210MHz (LTC2151), or 170MHz (LTC2150), LVDS outputs, differential $ENC^+/ENC^- = 2V_{P-P}$ sine wave, input range = $1.5V_{P-P}$ with differential drive, unless otherwise noted.

Note 6: Integral nonlinearity is defined as the deviation of a code from a best fit straight line to the transfer curve. The deviation is measured from the center of the quantization band.

Note 7: Offset error is the offset voltage measured from -0.5LSB when the output code flickers between 0000 0000 0000 and 1111 1111 1111 in 2's complement output mode.

Note 8: Guaranteed by design, not subject to test.

Note 9: Recommended operating conditions.

TYPICAL PERFORMANCE CHARACTERISTICS

LTC2152-12: Integral Nonlinearity (INL)

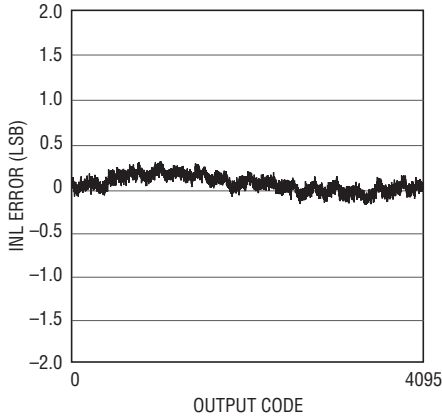

21521012 G01

LTC2152-12: Differential Nonlinearity (DNL)

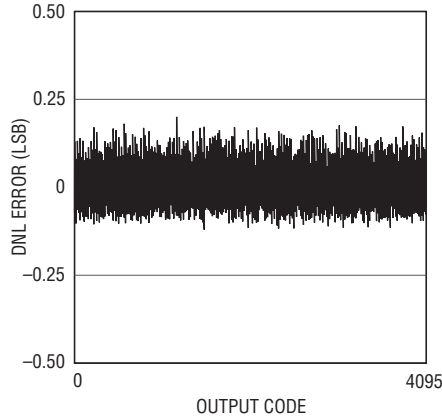

21521012 G02

LTC2152-12: 32K Point FFT, $f_{IN} = 15\text{MHz}$, -1dBFS, 250Mps

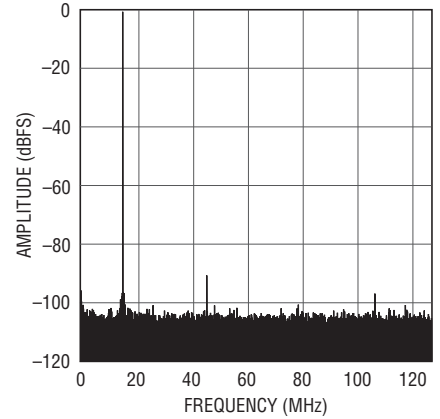

21521012 G03

LTC2152-12: 32K Point FFT, $f_{IN} = 70\text{MHz}$, -1dBFS, 250Mps

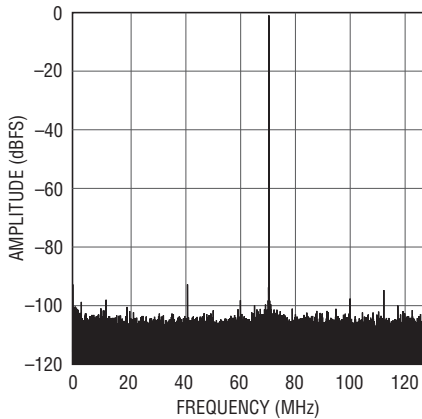

21521012 G04

LTC2152-12: 32K Point FFT, $f_{IN} = 122\text{MHz}$, -1dBFS, 250Mps

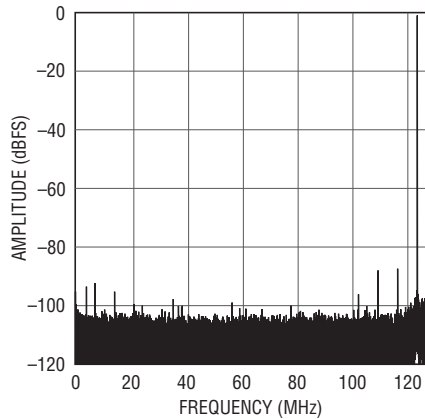

21521012 G05

LTC2152-12: 32K Point FFT, $f_{IN} = 171\text{MHz}$, -1dBFS, 250Mps

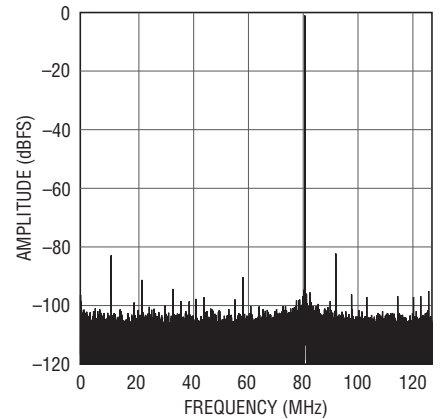

21521012 G06

LTC2152-12: 32K Point FFT, $f_{IN} = 229\text{MHz}$, -1dBFS, 250Mps

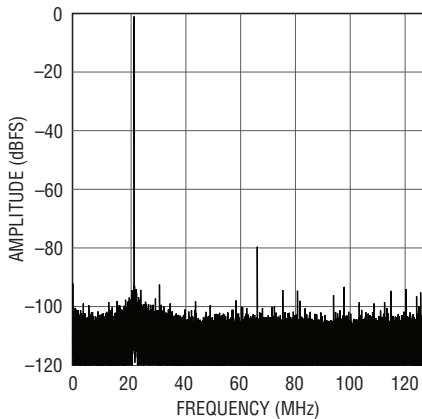

21521012 G07

LTC2152-12: 32K Point FFT, $f_{IN} = 380\text{MHz}$, -1dBFS, 250Mps

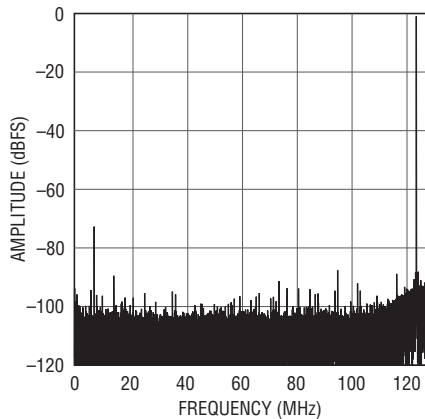

21521012 G08

LTC2152-12: 32K Point FFT, $f_{IN} = 420\text{MHz}$, -1dBFS, 250Mps

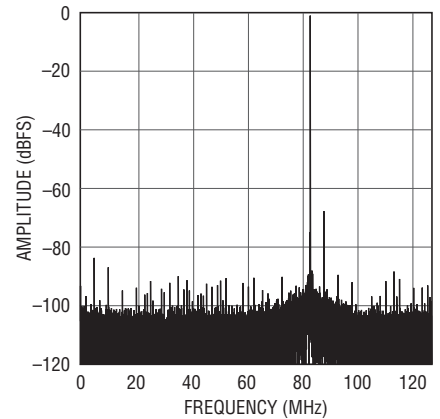

21521012 G09

21521012f

TYPICAL PERFORMANCE CHARACTERISTICS

LTC2152-12: 32K Point FFT,
 $f_{IN} = 567\text{MHz}$, -1dBFS , 250Msps

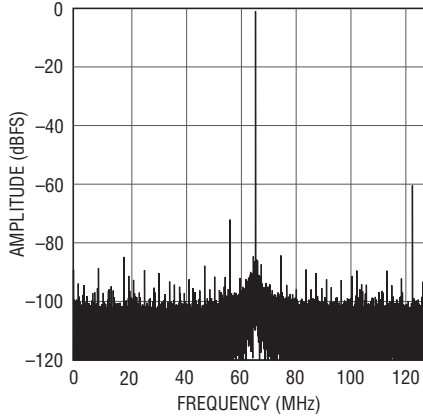

215210 G10

LTC2152-12: 32K Point FFT,
 $f_{IN} = 907\text{MHz}$, -1dBFS , 250Msps

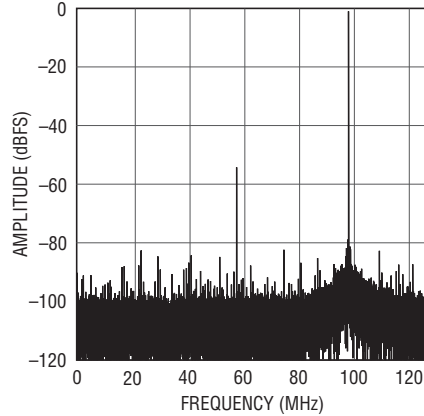

21521012 G11

LTC2152-12: 32K Point 2-Tone FFT,
 $f_{IN} = 71\text{MHz}$ and 69MHz , 250Msps

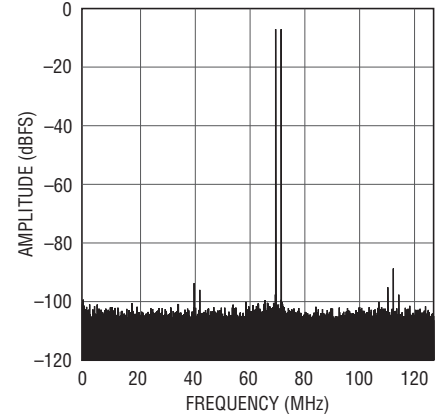

21521012 G12

LTC2152-12: Shorted Input
Histogram

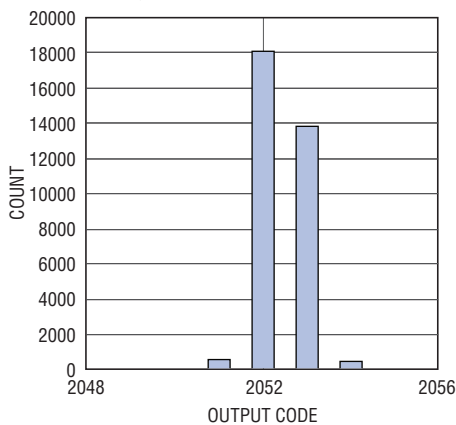

21521012 G13

LTC2152-12: $I_{OVD D}$ vs Sample Rate,
15MHz Sine Wave Input, -1dBFS

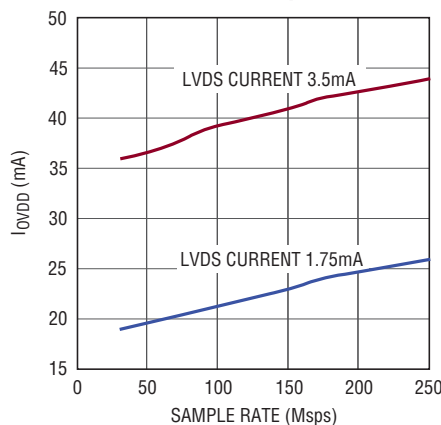

21521012 G14

LTC2152-12: $I_{OVD D}$ vs Sample Rate,
15MHz Sine Wave Input, -1dBFS

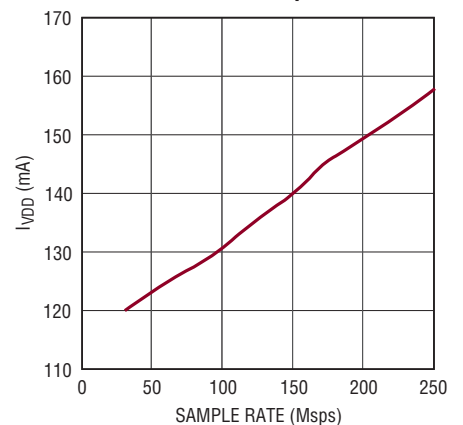

21521012 G15

LTC2152-12: SFDR vs Input Level,
 $f_{IN} = 70\text{MHz}$, 1.5V Range, 250Msps

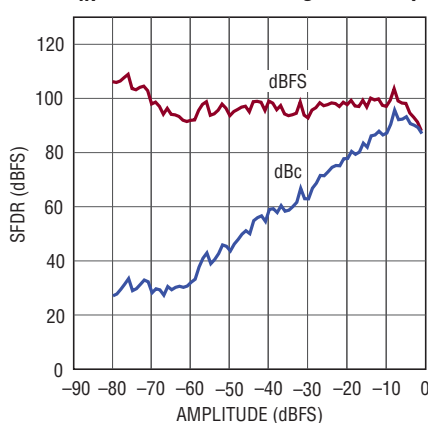

21521012 G16

LTC2152-12: SNR vs Input Level,
 $f_{IN} = 70\text{MHz}$, 1.5V Range, 250Msps

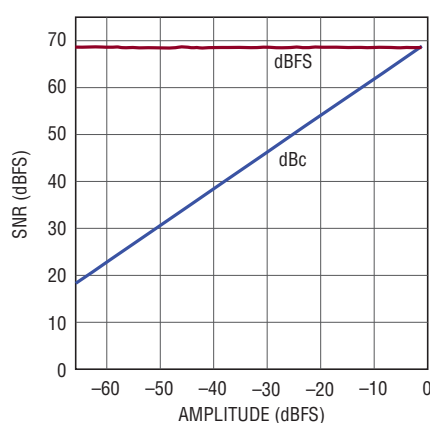

21521012 G17

LTC2152-12: SFDR vs Input
Frequency, -1dBFS , 1.5V Range,
250Msps

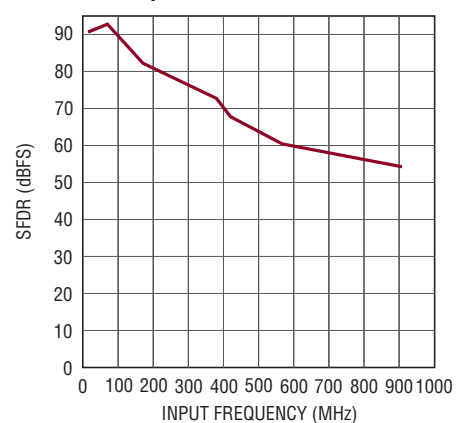

21521012 G18

21521012f

TYPICAL PERFORMANCE CHARACTERISTICS

LTC2152-12: SNR vs Input Frequency, -1dBFS, 1.5V Range, 250Mps

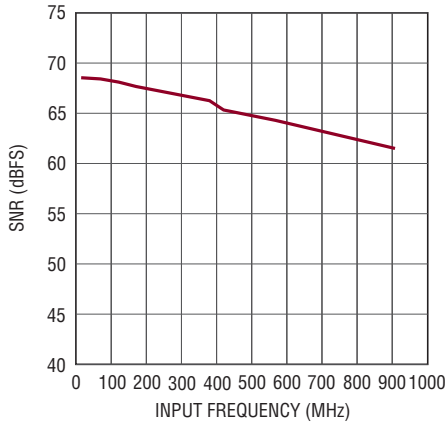

21521012 G19

LTC2152-12: Frequency Response

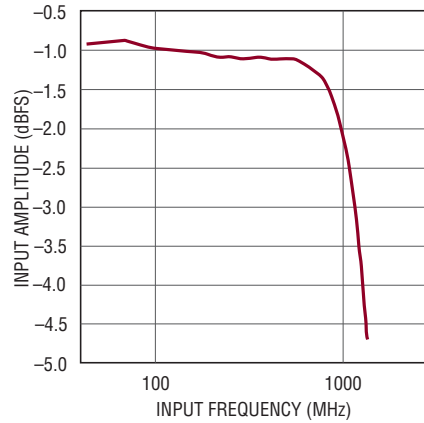

21521012 G20

LTC2151-12: Integral Nonlinearity INL

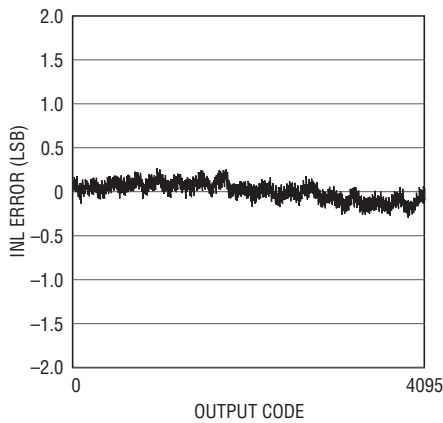

21521012 G21

LTC2151-12: Differential Nonlinearity DNL

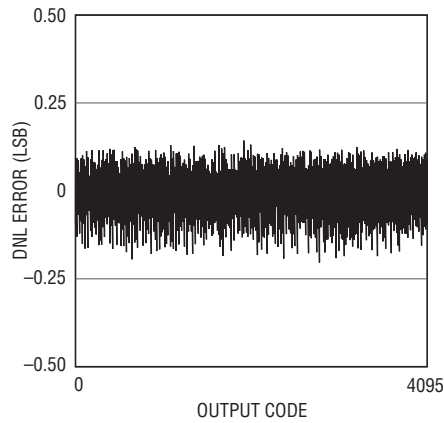

21521012 G22

LTC2151-12: 32K Point FFT, $f_{IN} = 15\text{MHz}$, -1dBFS, 210Mps

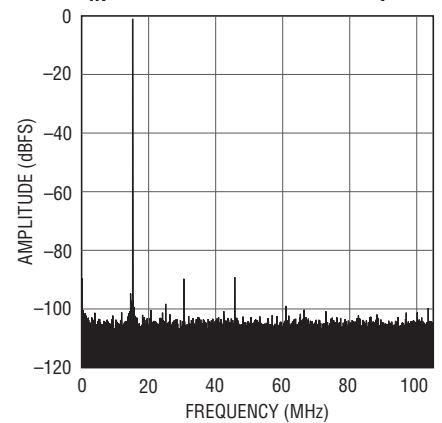

21521012 G23

LTC2151-12: 32K Point FFT, $f_{IN} = 71\text{MHz}$, -1dBFS, 210Mps

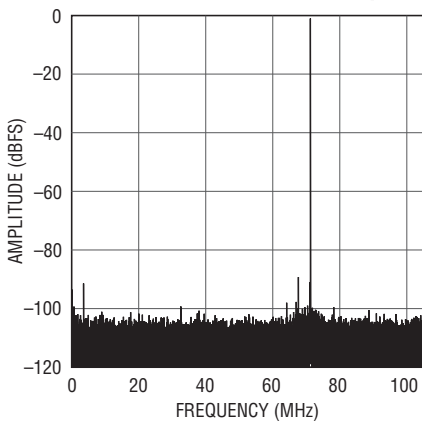

21521012 G24

LTC2151-12: 32K Point FFT, $f_{IN} = 101\text{MHz}$, -1dBFS, 210Mps

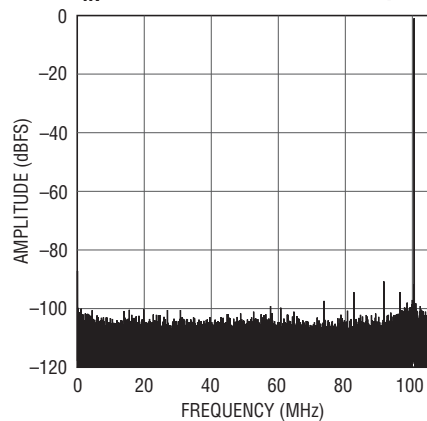

21521012 G25

LTC2151-12: 32K Point FFT, $f_{IN} = 171\text{MHz}$, -1dBFS, 210Mps

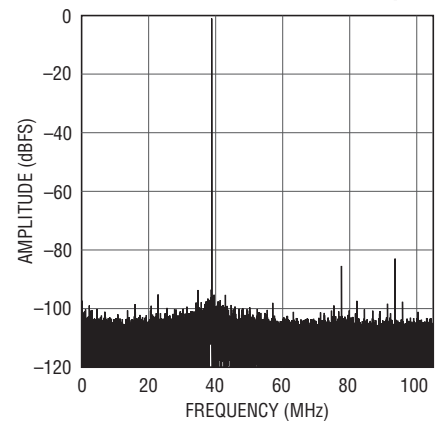

21521012 G26

21521012f

TYPICAL PERFORMANCE CHARACTERISTICS

LTC2151-12: 32K Point FFT,
 $f_{IN} = 227\text{MHz}$, -1dBFS , 210Msps

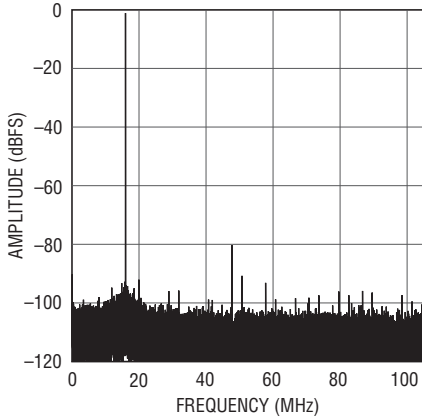

21521012 G27

LTC2151-12: 32K Point FFT,
 $f_{IN} = 379\text{MHz}$, -1dBFS , 210Msps

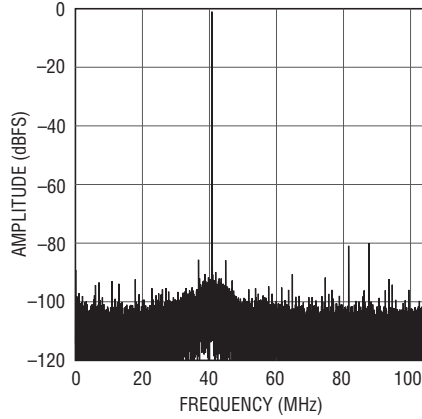

21521012 G28

LTC2151-12: 32K Point FFT,
 $f_{IN} = 417\text{MHz}$, -1dBFS , 210Msps

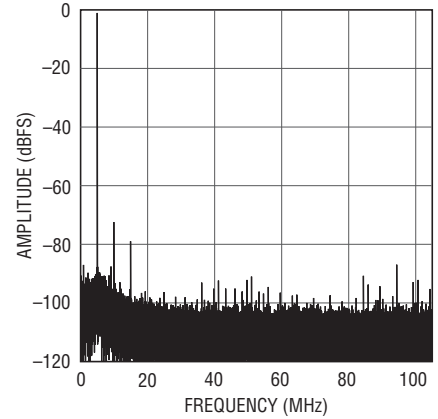

21521012 G29

LTC2151-12: 32K Point FFT,
 $f_{IN} = 567\text{MHz}$, -1dBFS , 210Msps

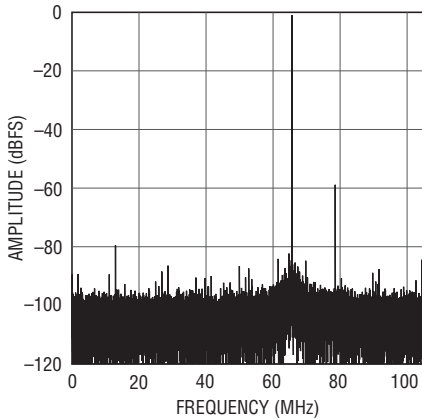

21521012 G30

LTC2151-12: 32K Point FFT,
 $f_{IN} = 907\text{MHz}$, -1dBFS , 210Msps

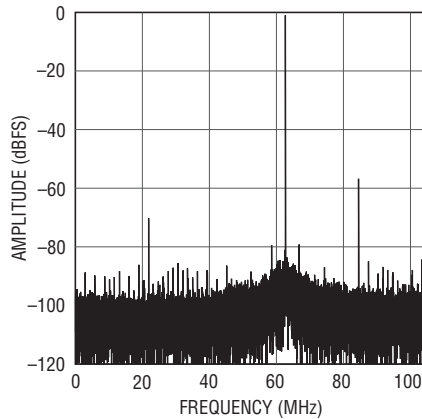

21521012 G31

LTC2151-12: 32K Point 2-Tone FFT,
 $f_{IN} = 71\text{MHz}$ and 69MHz , 210Msps

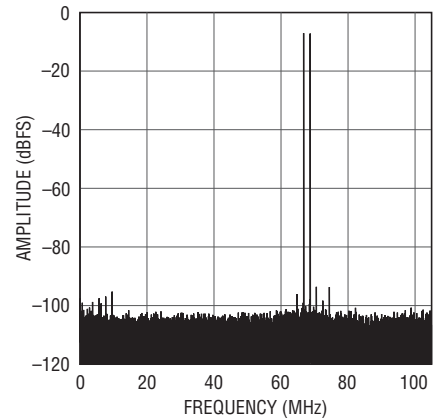

21521012 G32

LTC2151-12: Shorted Input
Histogram

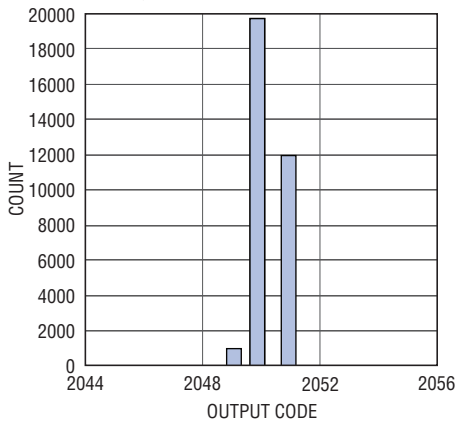

21521012 G33

LTC2151-12: I_{VDD} vs Sample Rate,
15MHz Sine Wave Input, -1dBFS

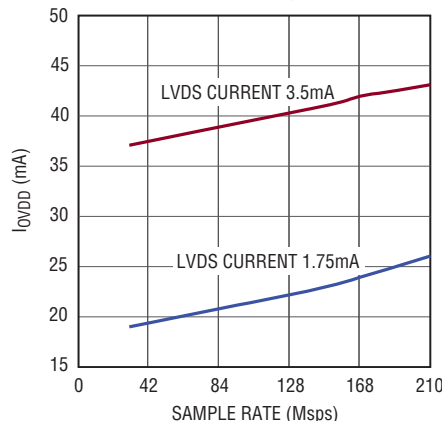

21521012 G34

LTC2151-12: I_{VDD} vs Sample Rate,
15MHz Sine Wave Input, -1dBFS

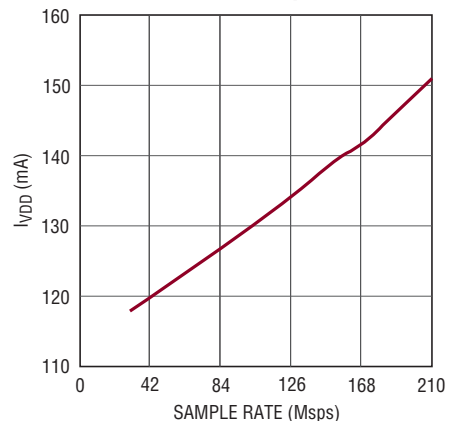

21521012 G35

21521012f

TYPICAL PERFORMANCE CHARACTERISTICS

LTC2151-12: SFDR vs Input Level,
 $f_{IN} = 70\text{MHz}$, 1.5V Range, 210Msps

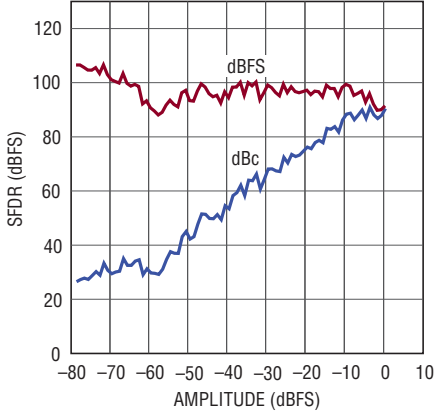

21521012 G36

LTC2151-12: SNR vs Input Level,
 $f_{IN} = 70\text{MHz}$, 1.5V Range, 210Msps

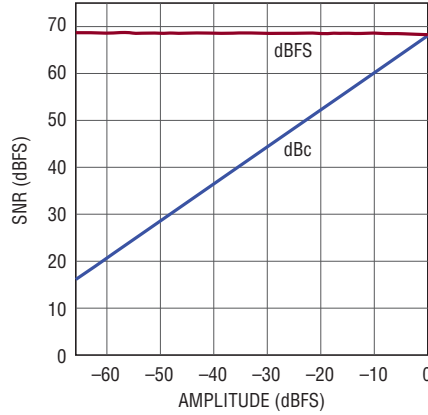

21521012 G37

LTC2151-12: SFDR vs Input Level,
-1dBFS, 1.5V Range, 210Msps

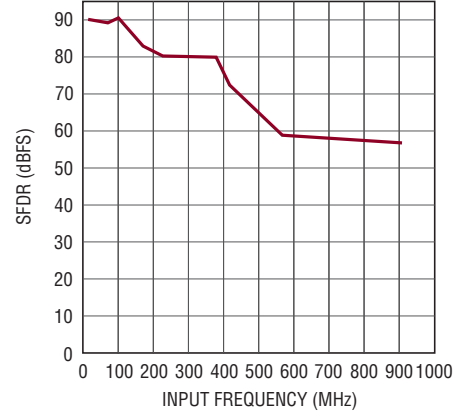

21521012 G38

LTC2151-12: SNR vs Input Level,
-1dBFS, 1.5V Range, 210Msps

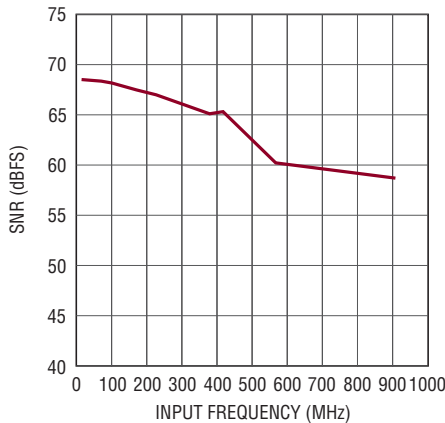

21521012 G39

LTC2151-12: Frequency Response

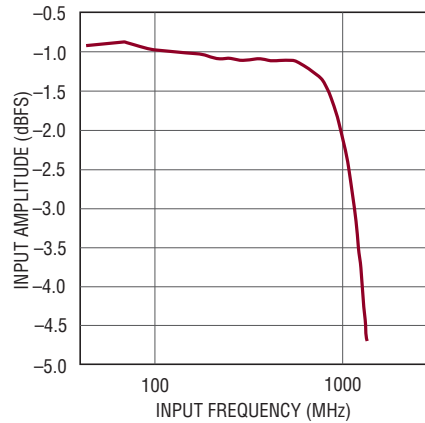

21521012 G40

LTC2150-12: Integral Nonlinearity INL

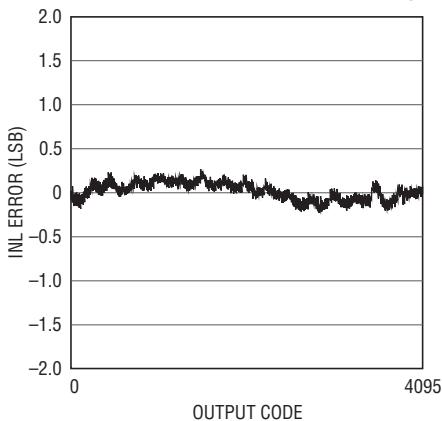

21521012 G41

LTC2150-12: Differential Nonlinearity DNL

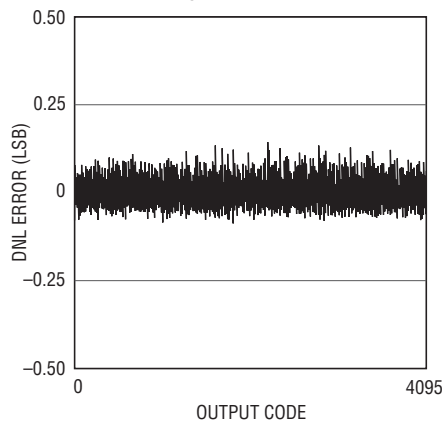

21521012 G42

LTC2150-12: 32K Point FFT,
 $f_{IN} = 15\text{MHz}$, -1dBFS, 170Msps

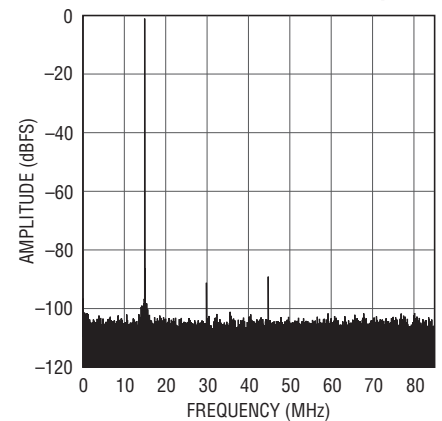

21521012 G43

21521012f

TYPICAL PERFORMANCE CHARACTERISTICS

LTC2150-12: 32K Point FFT,
 $f_{IN} = 70\text{MHz}$, -1dBFS , 170Mpsps

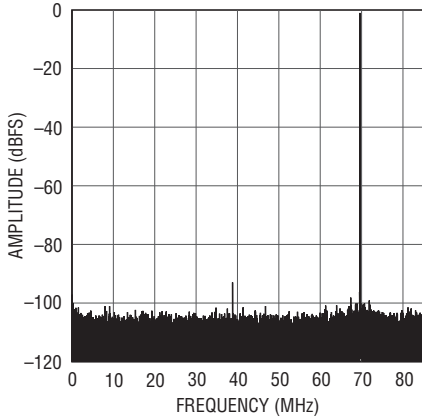

21521012 G44

LTC2150-12: 32K Point FFT,
 $f_{IN} = 121\text{MHz}$, -1dBFS , 170Mpsps

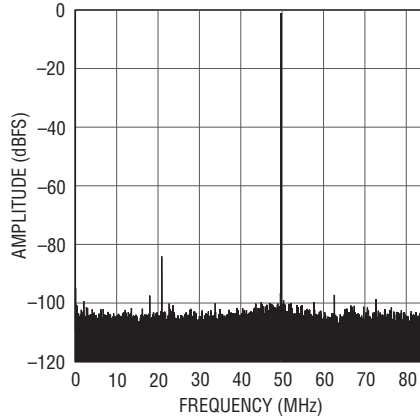

21521012 G45

LTC2150-12: 32K Point FFT,
 $f_{IN} = 176\text{MHz}$, -1dBFS , 170Mpsps

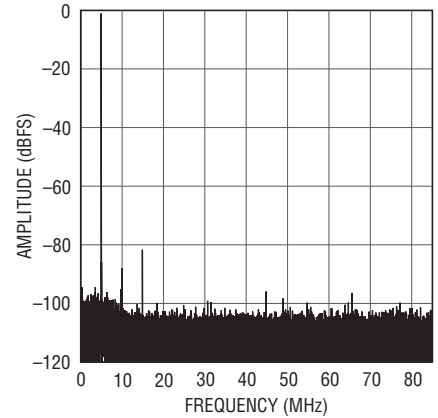

21521012 G46

LTC2150-12: 32K Point FFT,
 $f_{IN} = 225\text{MHz}$, -1dBFS , 170Mpsps

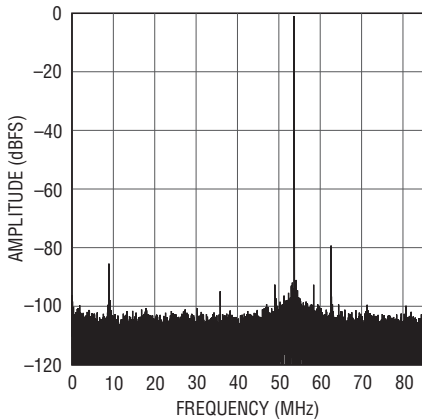

21521012 G47

LTC2150-12: 32K Point FFT,
 $f_{IN} = 380\text{MHz}$, -1dBFS , 170Mpsps

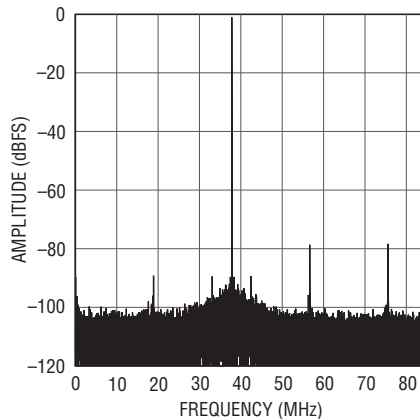

21521012 G48

LTC2150-12: 32K Point FFT,
 $f_{IN} = 420\text{MHz}$, -1dBFS , 170Mpsps

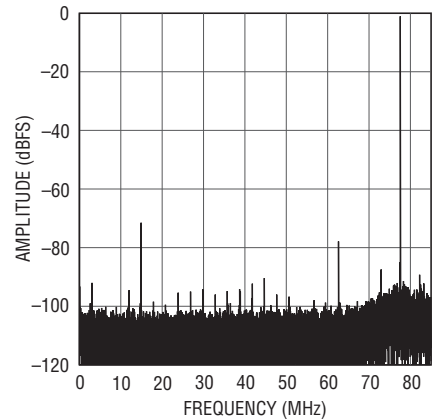

21521012 G49

LTC2150-12: 32K Point FFT,
 $f_{IN} = 567\text{MHz}$, -1dBFS , 170Mpsps

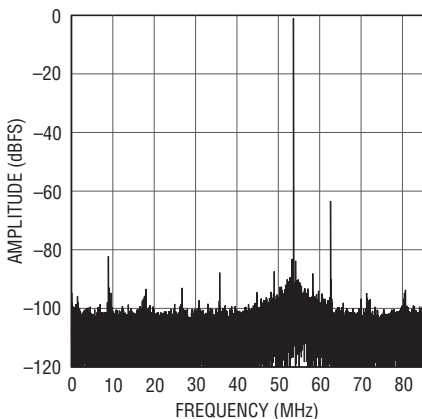

21521012 G50

LTC2150-12: 32K Point FFT,
 $f_{IN} = 907\text{MHz}$, -1dBFS , 170Mpsps

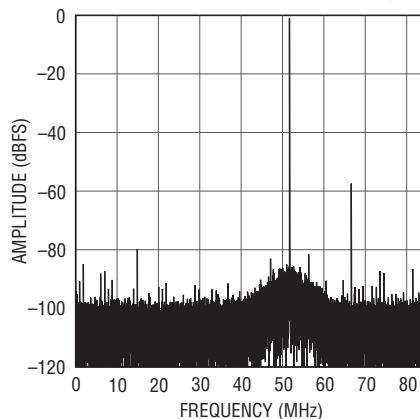

21521012 G51

LTC2150-12: 32K Point 2-Tone FFT,
 $f_{IN} = 71\text{MHz}$ and 69MHz , 170Mpsps

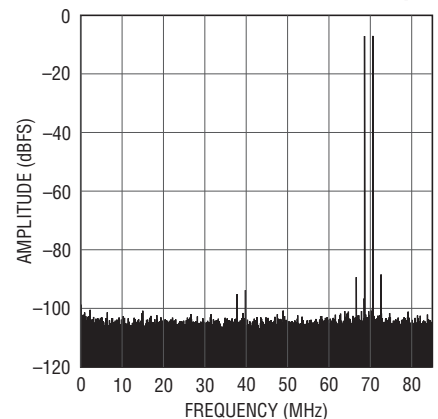

21521012 G52

21521012f

TYPICAL PERFORMANCE CHARACTERISTICS

LTC2150-12: Shorted Input Histogram

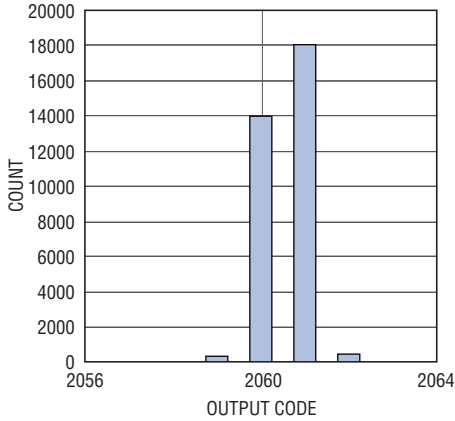

LTC2150-12: $I_{OVD D}$ vs Sample Rate, 15MHz Sine Wave Input, -1dBFS

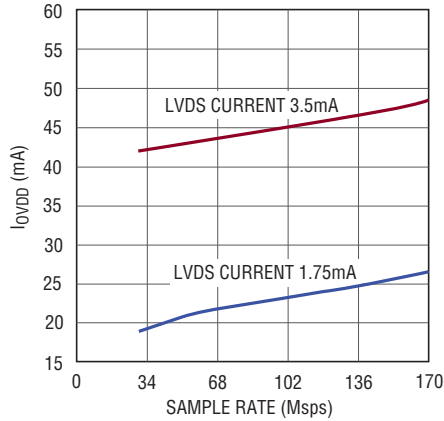

LTC2150-12: I_{VDD} vs Sample Rate, 15MHz Sine Wave Input, -1dBFS

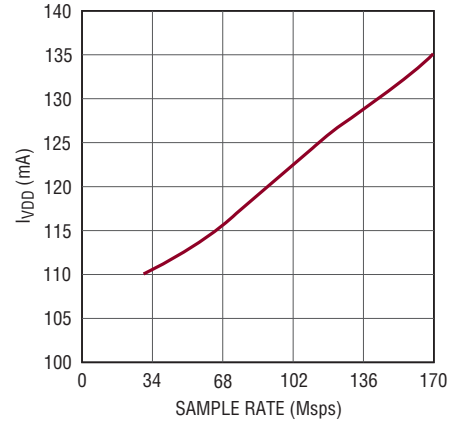

LTC2150-12: SFDR vs Input Level, $f_{IN} = 70\text{MHz}$, 1.5V Range, 170MSPS

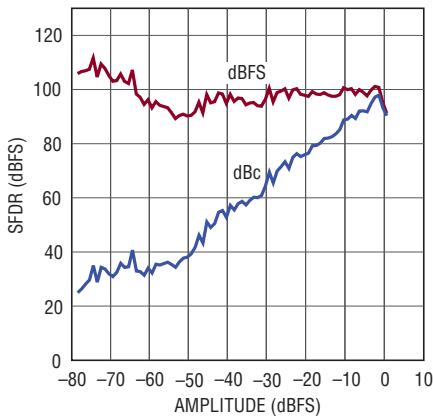

LTC2150-12: SNR vs Input Level, $f_{IN} = 70\text{MHz}$, 1.5V Range, 170MSPS

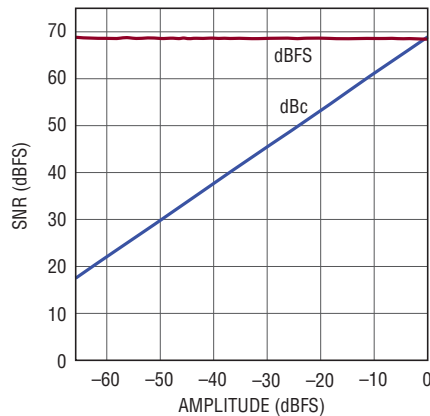

LTC2150-12: SFDR vs Input Frequency, -1dBFS, 1.5V Range, 170MSPS

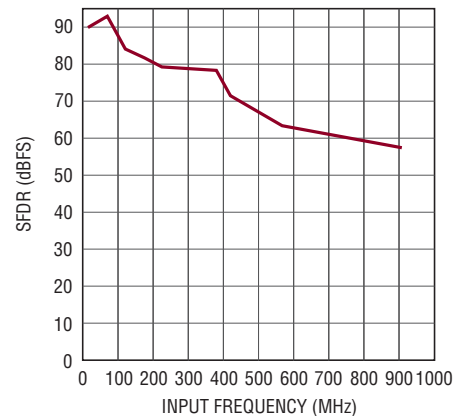

LTC2150-12: SNR vs Input Frequency, -1dBFS, 1.5V Range, 170MSPS

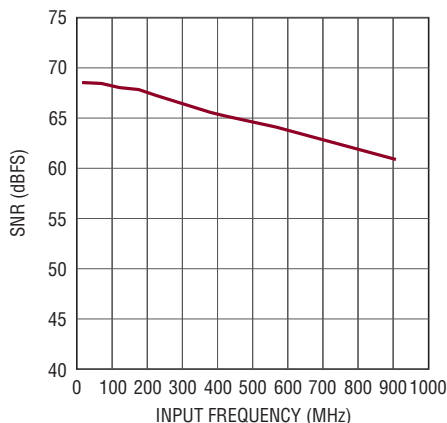

LTC2150-12: Frequency Response

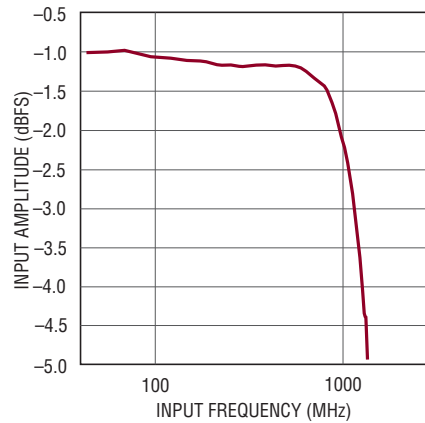

PIN FUNCTIONS

V_{DD} (Pins 1, 2): 1.8V Analog Power Supply. Bypass to ground with 0.1 μ F ceramic capacitor. Pins 1, 2 can share a bypass capacitor.

GND (Pins 3, 6, 10, 13, 35, Exposed Pad Pin 41): ADC Power Ground. The exposed pad must be soldered to the PCB ground.

A_{IN}⁺ (Pin 4): Positive Differential Analog Input.

A_{IN}⁻ (Pin 5): Negative Differential Analog Input.

SENSE (Pin 7): Reference Programming Pin. Connecting SENSE to V_{DD} selects the internal reference and a ± 0.75 V input range. An external reference between 1.2V and 1.3V applied to SENSE selects an input range of $\pm 0.6 \cdot V_{SENSE}$.

V_{REF} (Pin 8): Reference Voltage Output. Bypass to ground with a 2.2 μ F ceramic capacitor. Nominally 1.25V.

V_{CM} (Pin 9): Common Mode Bias Output; nominally equal to $0.439 \cdot V_{DD}$. V_{CM} should be used to bias the common mode of the analog inputs. Bypass to ground with a 0.1 μ F ceramic capacitor.

ENC⁺ (Pin 11): Encode Input. Conversion starts on the rising edge.

ENC⁻ (Pin 12): Encode Complement Input. Conversion starts on the falling edge.

NC (Pins 16, 17): No Connection.

OV_{DD} (Pins 20, 30): 1.8V Output Driver Supply. Bypass each pin to ground with separate 0.1 μ F ceramic capacitors.

OGND (Pin 21): LVDS Driver Ground.

SDO (Pin 36): In serial programming mode, ($\overline{\text{PAR/SER}} = 0\text{V}$), SDO is the optional serial interface data output. Data on SDO is read back from the mode control registers and can be latched on the falling edge of SCK. SDO is an open-drain N-channel MOSFET output that requires an external 2k pull-up resistor from 1.8V to 3.3V. If readback from the mode control registers is not needed, the pull-up resistor is not necessary and SDO can be left unconnected.

SDI (Pin 37): In serial programming mode, ($\overline{\text{PAR/SER}} = 0\text{V}$), SDI is the serial interface data input. Data on SDI is clocked into the mode control registers on the rising edge of SCK. In parallel programming mode ($\overline{\text{PAR/SER}} = V_{DD}$), SDI selects 3.5mA or 1.75mA LVDS output current (see Table 2).

SCK (Pin 38): In serial programming mode, ($\overline{\text{PAR/SER}} = 0\text{V}$), SCK is the serial interface clock input. In parallel programming mode ($\overline{\text{PAR/SER}} = V_{DD}$), SCK controls the sleep mode (see Table 2).

$\overline{\text{CS}}$ (Pin 39): In serial programming mode, ($\overline{\text{PAR/SER}} = 0\text{V}$), $\overline{\text{CS}}$ is the serial interface chip select input. When $\overline{\text{CS}}$ is low, SCK is enabled for shifting data on SDI into the mode control registers. In parallel programming mode ($\overline{\text{PAR/SER}} = V_{DD}$), $\overline{\text{CS}}$ controls the clock duty cycle stabilizer (see Table 2).

$\overline{\text{PAR/SER}}$ (Pin 40): Programming Mode Selection Pin. Connect to ground to enable the serial programming mode. $\overline{\text{CS}}$, SCK, SDI and SDO become a serial interface that control the A/D operating modes. Connect to V_{DD} to enable the parallel programming mode where $\overline{\text{CS}}$, SCK and SDI become parallel logic inputs that control a reduced set of the A/D operating modes. $\overline{\text{PAR/SER}}$ should be connected directly to ground or the V_{DD} of the part and not be driven by a logic signal.

PIN FUNCTIONS

LVDS Outputs (DDR LVDS)

The following pins are differential LVDS outputs. The output current level is programmable. There is an optional internal 100Ω termination resistor between the pins of each LVDS output pair.

D_{0_1}⁻/D_{0_1}⁺ to D_{10_11}⁻/D_{10_11}⁺ (Pins 18/19, 22/23, 24/25, 28/29, 31/32, 33/34): Double-Data Rate Digital Outputs. Two data bits are multiplexed onto each differential output pair. The even data bits (D0, D2, D4, D6, D8, D10) appear when CLKOUT⁺ is low. The odd data bits (D1, D3, D5, D7, D9, D11) appear when CLKOUT⁺ is high.

CLKOUT⁻/CLKOUT⁺ (Pins 26/27): Data Output Clock. The digital outputs normally transition at the same time as the falling and rising edges of CLKOUT⁺. The phase of CLKOUT⁺ can also be delayed relative to the digital outputs by programming the mode control registers.

OF⁻/OF⁺ (Pins 14/15): Over/Underflow Digital Output. OF⁺ is high when an overflow or underflow has occurred. This underflow is valid only when CLKOUT⁺ is low. In the second half clock cycle, the overflow is set to 0.

FUNCTIONAL BLOCK DIAGRAM

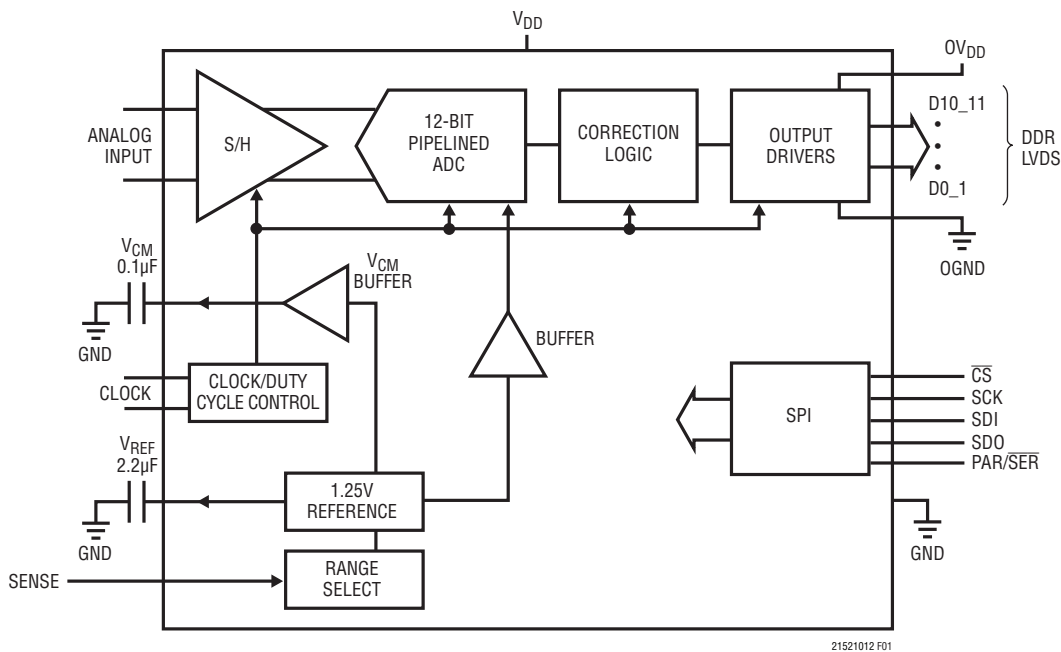
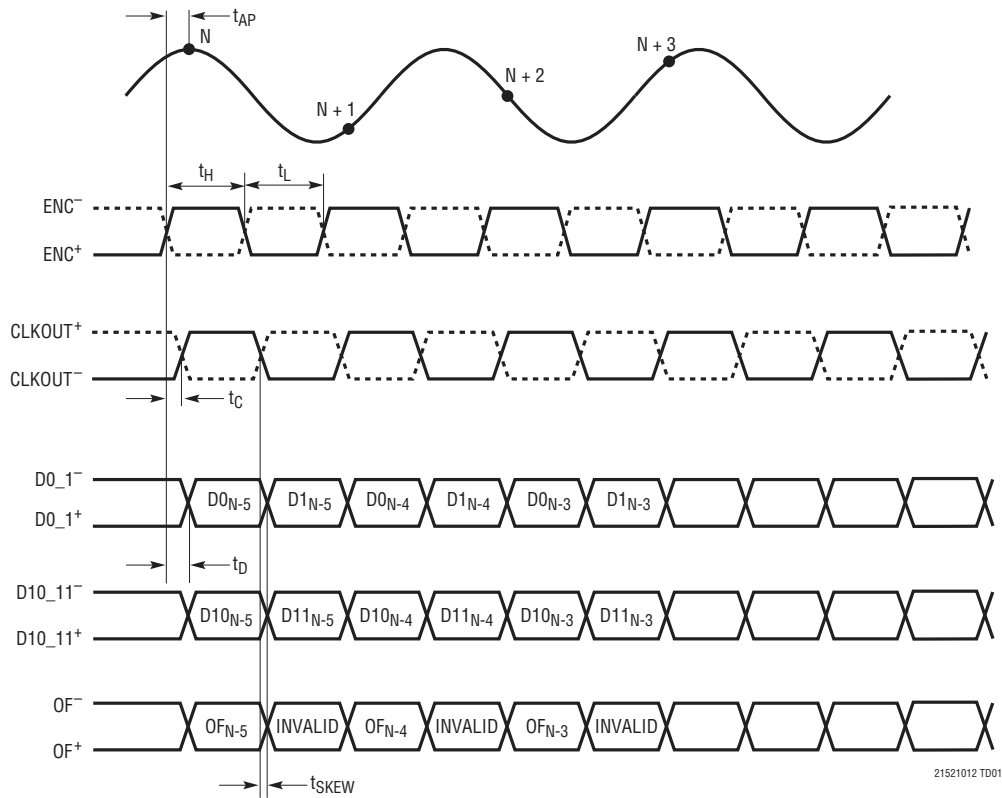

Figure 1. Functional Block Diagram

TIMING DIAGRAMS

Double-Data Rate Output Timing, All Outputs Are Differential LVDS



SPI Port Timing (Readback Mode)

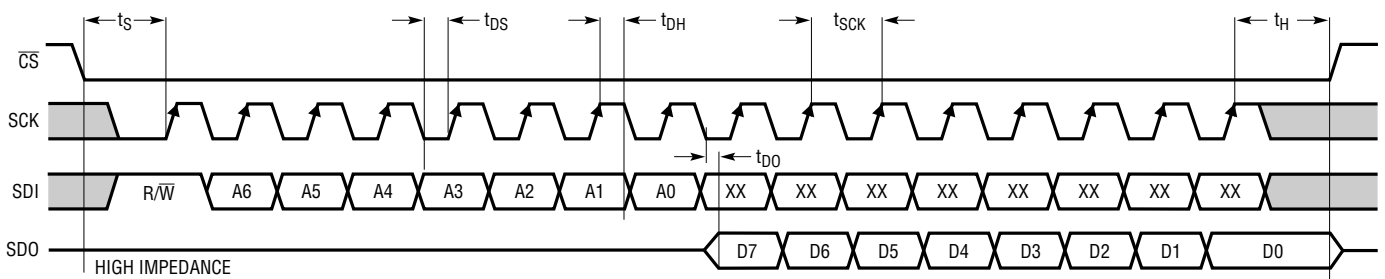

SPI Port Timing (Write Mode)

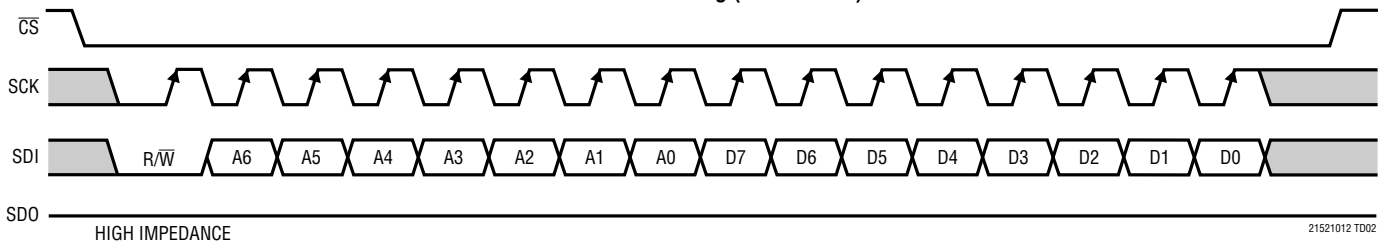

APPLICATIONS INFORMATION

CONVERTER OPERATION

The LTC2152-12/LTC2151-12/LTC2150-12 are 12-bit 250Msps/210Msps/170Msps A/D converters that are powered by a single 1.8V supply. The analog inputs must be driven differentially. The encode inputs should be driven differentially for optimal performance. The digital outputs are double-data rate LVDS. Additional features can be chosen by programming the mode control registers through a serial SPI port.

ANALOG INPUT

The analog input is a differential CMOS sample-and-hold circuit (Figure 2). It must be driven differentially around a common mode voltage set by the V_{CM} output pin, which is nominally $0.439 \cdot V_{DD}$. The inputs should swing from $V_{CM} - 0.375V$ to $V_{CM} + 0.375V$. There should be a 180° phase difference between the inputs.

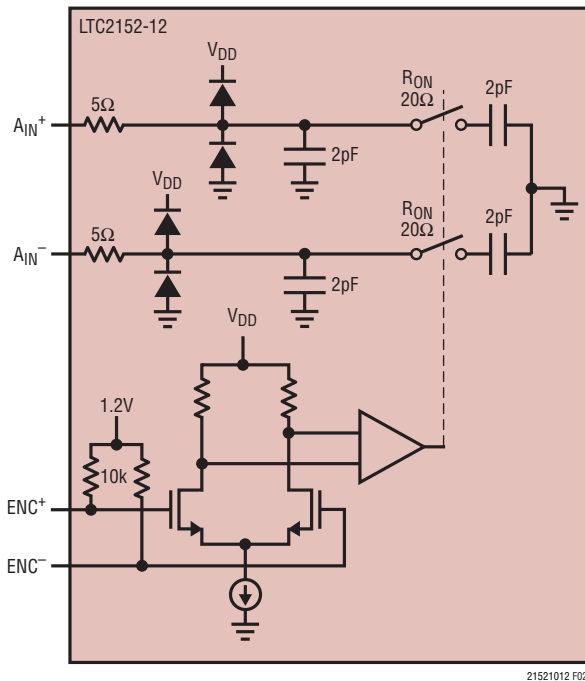

Figure 2. Equivalent Input Circuit for Differential Input Clock

INPUT DRIVE CIRCUITS

Input Filtering

If possible, there should be an RC lowpass filter right at the analog inputs. This lowpass filter isolates the drive circuitry from the A/D sample-and-hold switching, and also limits wide band noise from the drive circuitry. Figure 3 shows an example of an input RC filter. The RC component values should be chosen based on the application's input frequency.

Transformer-Coupled Circuits

Figure 3 shows the analog input being driven by an RF transformer with the common mode supplied through a pair of resistors via the V_{CM} pin.

At higher input frequencies a transmission line balun transformer (Figures 4 and 5) has better balance, resulting in lower A/D distortion.

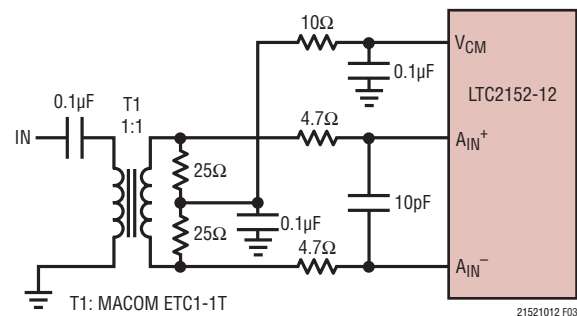

Figure 3. Analog Input Circuit Using a Transformer. Recommended for Input Frequencies from 5MHz to 70MHz

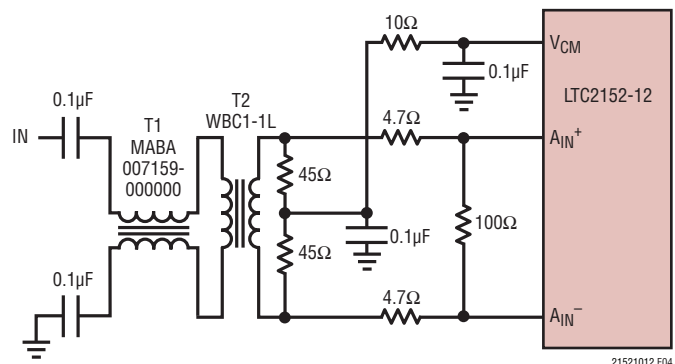

Figure 4. Recommended Front-End Circuit for Input Frequencies from 15MHz to 150MHz

APPLICATIONS INFORMATION

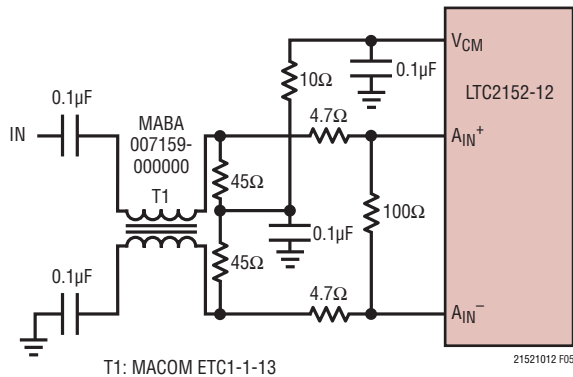

Figure 5. Recommended Front-End Circuit for Input Frequencies from 150MHz Up to 900MHz

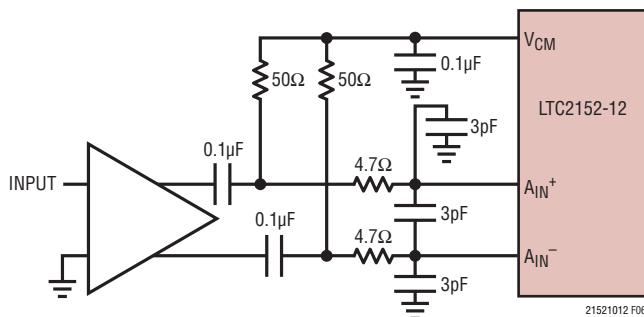

Figure 6. Front-End Circuit Using a High Speed Differential Amplifier

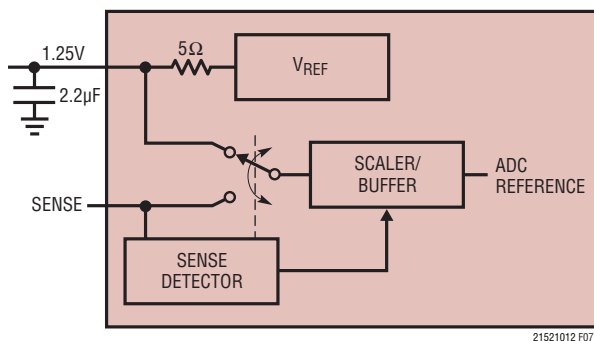

Figure 7. Reference Circuit

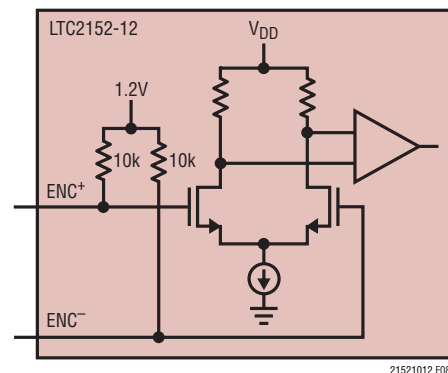

Figure 8. Equivalent Encode Input Circuit

Amplifier Circuits

Figure 6 shows the analog input being driven by a high speed differential amplifier. The output of the amplifier is AC-coupled to the A/D so the amplifier's output common mode voltage can be optimally set to minimize distortion.

At very high frequencies an RF gain block will often have lower distortion than a differential amplifier. If the gain block is single-ended, then a transformer circuit (Figures 3 and 5) should convert the signal to differential before driving the A/D. The A/D cannot be driven single-ended.

Reference

The LTC2152-12/LTC2151-12/LTC2150-12 has an internal 1.25V voltage reference. For a 1.5V input range with internal reference, connect SENSE to V_{DD} . For a 1.5V input range with an external reference, apply a 1.25V reference voltage to SENSE (Figure 7).

Encode Input

The signal quality of the encode inputs strongly affects the A/D noise performance. The encode inputs should be treated as analog signals—do not route them next to digital traces on the circuit board.

The encode inputs are internally biased to 1.2V through 10k equivalent resistance (Figure 8). If the common mode of the driver is within 1.1V to 1.5V, it is possible to drive

APPLICATIONS INFORMATION

the encode inputs directly. Otherwise, a transformer or coupling capacitors are needed (Figures 9 and 10). The maximum (peak) voltage of the input signal should never exceed $V_{DD} + 0.1V$ or go below $-0.1V$.

Clock Duty Cycle Stabilizer

For good performance the encode signal should have a 50% ($\pm 5\%$) duty cycle. If the optional clock duty cycle stabilizer circuit is enabled, the encode duty cycle can vary from 30% to 70% and the duty cycle stabilizer will maintain a constant 50% internal duty cycle. If the encode signal changes frequency or is turned off, the duty cycle stabilizer circuit requires one hundred clock cycles to lock onto the input clock. The duty cycle stabilizer is enabled via SPI Register A2 (see SPI Control Register) or by \overline{CS} in parallel programming mode.

For applications where the sample rate needs to be changed quickly, the clock duty cycle stabilizer can be disabled. If the duty cycle stabilizer is disabled, care should be taken to make the sampling clock have a 50% ($\pm 5\%$) duty cycle.

DIGITAL OUTPUTS

The digital outputs are double-data rate LVDS signals. Two data bits are multiplexed and output on each differential output pair. There are six LVDS output pairs (DO_1+/DO_1- through D10_11-/D10_11+). Overflow (OF+/OF-) and the data output clock (CLKOUT+/CLKOUT-) each have an LVDS output pair.

By default the outputs are standard LVDS levels: 3.5mA output current and a 1.25V output common mode voltage.

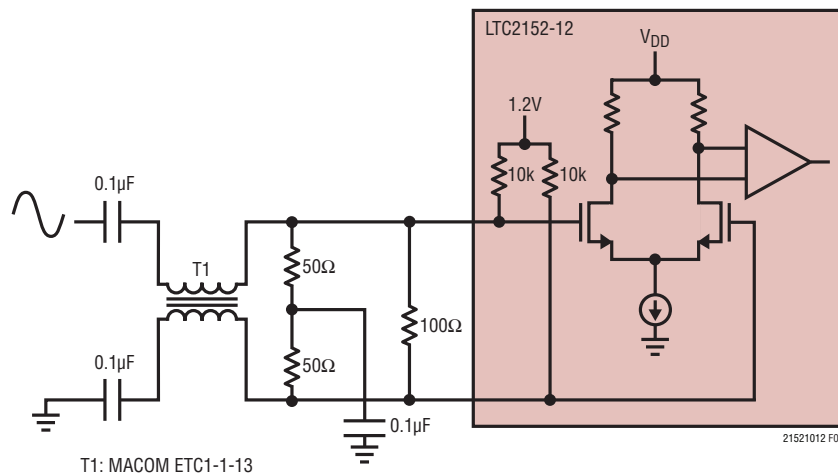

Figure 9. Sinusoidal Encode Drive

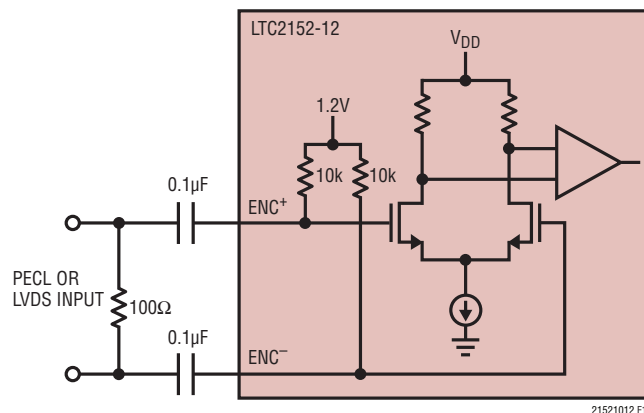

Figure 10. PECL or LVDS Encode Drive

APPLICATIONS INFORMATION

An external 100Ω differential termination resistor is required for each LVDS output pair. The termination resistors should be located as close as possible to the LVDS receiver.

The outputs are powered by OV_{DD} and $OGND$, which are isolated from the A/D core power and ground.

Programmable LVDS Output Current

The default output driver current is 3.5mA. This current can be adjusted by serially programming mode control register A3 (see Table 3). Available current levels are 1.75mA, 2.1mA, 2.5mA, 3mA, 3.5mA, 4mA and 4.5mA.

Optional LVDS Driver Internal Termination

In most cases, using just an external 100Ω termination resistor will give excellent LVDS signal integrity. In addition, an optional internal 100Ω termination resistor can be enabled by serially programming mode control register A3. The internal termination helps absorb any reflections caused by imperfect termination at the receiver. When the internal termination is enabled, the output driver current is doubled to maintain the same output voltage swing.

Overflow Bit

The overflow output bit (OF) outputs a logic high when the analog input is either overranged or underranged. The overflow bit has the same pipeline latency as the data bits.

When $CLKINV$ is set to 0 in the SPI register A2, OF signal is valid when $CLKOUT^+$ is low as shown in the Timing Diagram.

Phase Shifting the Output Clock

To allow adequate setup and hold time when latching the output data, the $CLKOUT^+$ signal may need to be phase shifted relative to the data output bits. Most FPGAs have this feature; this is generally the best place to adjust the timing.

Alternatively, the ADC can also phase shift the $CLKOUT^+$ / $CLKOUT^-$ signals by serially programming mode control register A2. The output clock can be shifted by 0°, 45°, 90°, or 135°. To use the phase shifting feature, the clock duty cycle stabilizer must be turned on. Another control register bit can invert the polarity of $CLKOUT^+$ and $CLKOUT^-$, independently of the phase shift. The combination of these two features enables phase shifts of 45° up to 315° (Figure 11).

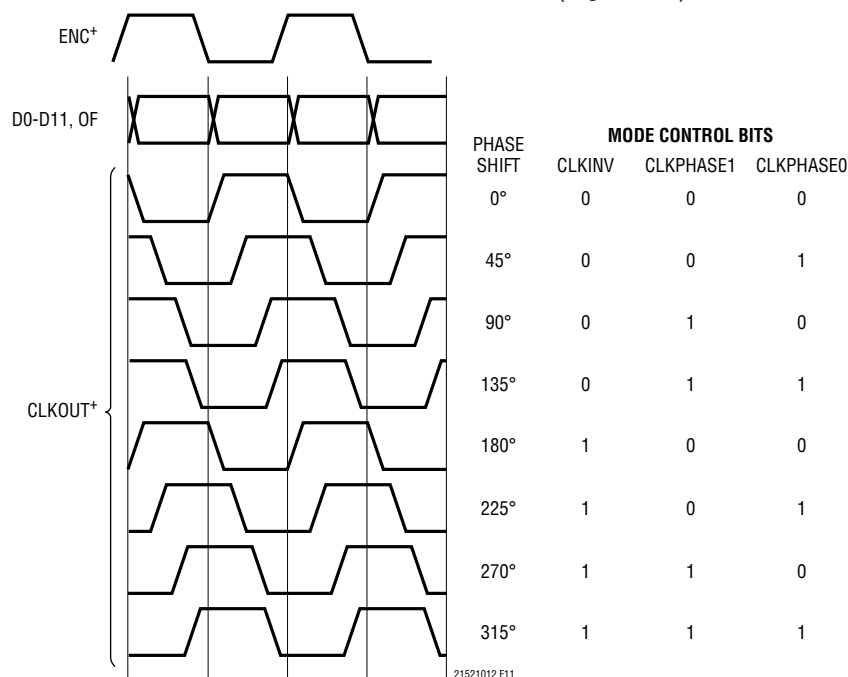

Figure 11. Phase-Shifting CLKOUT

APPLICATIONS INFORMATION

DATA FORMAT

Table 1 shows the relationship between the analog input voltage, the digital data output bits and the overflow bit. By default the output data format is offset binary. The 2's complement format can be selected by serially programming mode control register A4.

Table 1. Output Codes vs Input Voltage

$A_{IN}^+ - A_{IN}^-$ (1.5V Range)	OF	D11-D0 (OFFSET BINARY)	D11-D0 (2's COMPLEMENT)
>0.75V	1	1111 1111 1111	0111 1111 1111
+0.75V	0	1111 1111 1111	0111 1111 1111
+0.7496337V	0	1111 1111 1110	0111 1111 1110
+0.0003662V	0	1000 0000 0001	0000 0000 0001
+0.000000V	0	1000 0000 0000	0000 0000 0000
-0.0003662V	0	0111 1111 1111	1111 1111 1111
-0.0007324V	0	0111 1111 1110	1111 1111 1110
-0.74963378V	0	0000 0000 0001	1000 0000 0001
-0.75V	0	0000 0000 0000	1000 0000 0000
<-0.75V	1	0000 0000 0000	1000 0000 0000

Digital Output Randomizer

Interference from the A/D digital outputs is sometimes unavoidable. Digital interference may be from capacitive or inductive coupling or coupling through the ground plane. Even a tiny coupling factor can cause unwanted tones in the ADC output spectrum. By randomizing the digital output before it is transmitted off-chip, these unwanted tones can be randomized, which reduces the unwanted tone amplitude.

The digital output is randomized by applying an exclusive-OR logic operation between the LSB and all other data output bits. To decode, the reverse operation is applied—an exclusive-OR operation is applied between the LSB and all other bits. The LSB, OF and CLKOUT outputs are not affected. The output randomizer is enabled by serially programming mode control register A4.

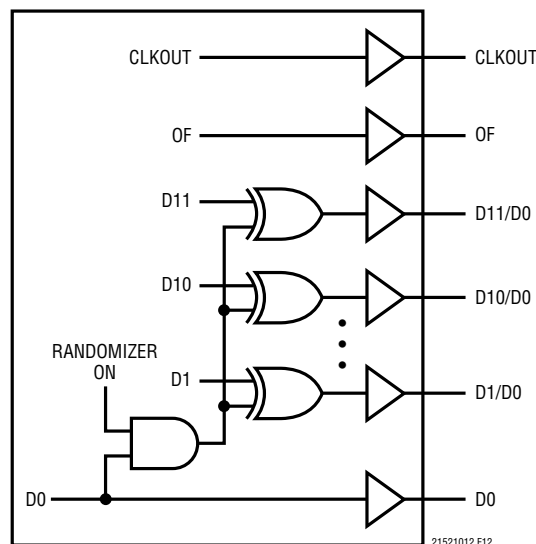

Figure 12. Functional Equivalent of Digital Output Randomizer

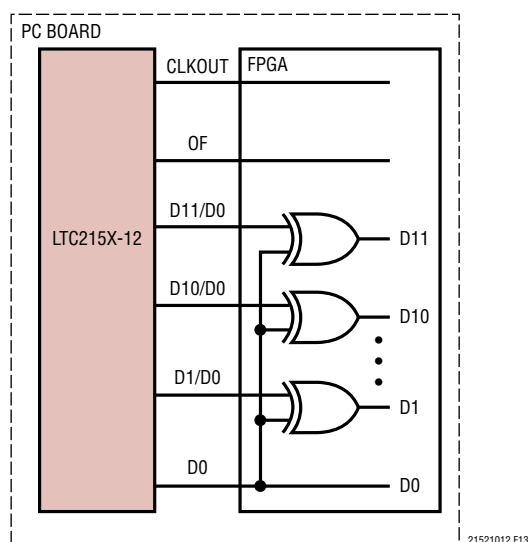

Figure 13. Unrandomizing for Randomized Digital Output Signal

APPLICATIONS INFORMATION

Alternate Bit Polarity

Another feature that may reduce digital feedback on the circuit board is the alternate bit polarity mode. When this mode is enabled, all of the odd bits (D1, D3, D5, D7, D9, D11) are inverted before the output buffers. The even bits (D0, D2, D4, D6, D8, D10), OF and CLKOUT are not affected. This can reduce digital currents in the circuit board ground plane and reduce digital noise, particularly for very small analog input signals.

The digital output is decoded at the receiver by inverting the odd bits (D1, D3, D5, D7, D9, D11). The alternate bit polarity mode is independent of the digital output randomizer—either both or neither function can be on at the same time. The alternate bit polarity mode is enabled by serially programming mode control register A4.

Digital Output Test Patterns

To allow in-circuit testing of the digital interface to the A/D, there are several test modes (activate by setting DTESTON) that force the A/D data outputs (OF, D11 to D0) to known values:

All 1s: All outputs are 1

All 0s: All outputs are 0

Alternating: Outputs change from all 1s to all 0s on alternating samples

Checkerboard: Outputs change from 101010101010 to 0101010101010 on alternating samples.

The digital output test patterns are enabled by serially programming mode control register A4. When enabled, the test patterns override all other formatting modes: 2's complement, randomizer, alternate-bit polarity.

Output Disable

The digital outputs may be disabled by serially programming mode control register A3. All digital outputs, including OF and CLKOUT, are disabled. The high impedance disabled state is intended for long periods of inactivity, it is not designed for multiplexing the data bus between multiple converters.

Sleep Mode

The A/D may be placed in a power-down mode to conserve power. In sleep mode, the entire A/D converter is powered down, resulting in $< 2\text{mW}$ power consumption. If the encode input signal is not disabled, the power consumption will be higher (up to 2mW at 250Mps). Sleep mode is enabled by mode control register A1 (serial programming mode), or by SCK (parallel programming mode).

The amount of time required to recover from sleep mode depends on the size of the bypass capacitors on V_{REF} . For the suggested values in Figure 1, the A/D will stabilize after $0.1\text{ms} + 2500 \cdot t_p$ where t_p is the period of the sampling clock.

Nap Mode

In nap mode the A/D core is powered down while the internal reference circuits stay active, allowing faster wakeup. Recovering from nap mode requires at least 100 clock cycles. Wake-up time from nap mode is guaranteed only if the clock is kept running, otherwise sleep mode, wake-up time conditions apply. Nap mode is enabled by setting register A1 in the serial programming mode.

DEVICE PROGRAMMING MODES

The operating modes of the LTC215X-12 can be programmed by either a parallel interface or a simple serial interface. The serial interface has more flexibility and can program all available modes. The parallel interface is more limited and can only program some of the more commonly used modes.

Parallel Programming Mode

To use the parallel programming mode, $\overline{\text{PAR}}/\overline{\text{SER}}$ should be tied to V_{DD} . The $\overline{\text{CS}}$, SCK and SDI pins are binary logic inputs that set certain operating modes. These pins can be tied to V_{DD} or ground, or driven by 1.8V, 2.5V, or 3.3V CMOS logic. Table 2 shows the modes set by $\overline{\text{CS}}$, SCK and SDI.

APPLICATIONS INFORMATION

Table 2. Parallel Programming Mode Control Bits)

PIN	DESCRIPTION
\overline{CS}	Clock Duty Cycle Stabilizer Control Bit 0 = Clock Duty Cycle Stabilizer Off 1 = Clock Duty Cycle Stabilizer On
SCK	Power-Down Control Bit 0 = Normal Operation 1 = Sleep Mode (entire ADC is powered down)
SDI	LVDS Current Selection Bit 0 = 3.5mA LVDS Current Mode 1 = 1.75mA LVDS Current Mode

Serial Programming Mode

To use the serial programming mode, $\overline{PAR}/\overline{SER}$ should be tied to ground. The \overline{CS} , SCK, SDI and SDO pins become a serial interface that program the A/D control registers. Data is written to a register with a 16-bit serial word. Data can also be read back from a register to verify its contents.

Serial data transfer starts when \overline{CS} is taken low. The data on the SDI pin is latched at the first sixteen rising edges of SCK. Any SCK rising edges after the first sixteen are ignored. The data transfer ends when \overline{CS} is taken high again.

The first bit of the 16-bit input word is the R/\overline{W} bit. The next seven bits are the address of the register (A6:A0). The final eight bits are the register data (D7:D0).

If the R/\overline{W} bit is low, the serial data (D7:D0) will be written to the register set by the address bits (A6:A0). If the R/\overline{W} bit is high, data in the register set by the address bits (A6:A0) will be read back on the SDO pin (see the Timing Diagrams). During a readback command the register is not updated and data on SDI is ignored.

The SDO pin is an open-drain output that pulls to ground with a 200 Ω impedance. If register data is read back through SDO, an external 2k pull-up resistor is required. If serial data is only written and readback is not needed, then SDO can be left floating and no pull-up resistor is needed. Table 3 shows a map of the mode control registers.

Software Reset

If serial programming is used, the mode control registers should be programmed as soon as possible after the power supplies turn on and are stable. The first serial command must be a software reset which will reset all register data bits to logic 0. To perform a software reset it is necessary to write 1 in register A0 (Bit D7). After the reset is complete, Bit D7 is automatically set back to zero. This register is WRITE-ONLY.

GROUNDING AND BYPASSING

The LTC215X-12 requires a printed circuit board with a clean unbroken ground plane in the first layer beneath the ADC. A multilayer board with an internal ground plane is recommended. Layout for the printed circuit board should ensure that digital and analog signal lines are separated as much as possible. In particular, care should be taken not to run any digital track alongside an analog signal track or underneath the ADC.

High quality ceramic bypass capacitors should be used at the V_{DD} , OV_{DD} , V_{CM} and V_{REF} pins. Bypass capacitors must be located as close to the pins as possible. Size 0402 ceramic capacitors are recommended. The traces connecting the pins and bypass capacitors must be kept short and should be made as wide as possible.

The analog inputs, encode signals and digital outputs should not be routed next to each other. Ground fill and grounded vias should be used as barriers to isolate these signals from each other.

HEAT TRANSFER

Most of the heat generated by the LTC215X-12 is transferred from the die through the bottom-side exposed pad and package leads onto the printed circuit board. For good electrical and thermal performance, the exposed pad must be soldered to a large grounded pad on the PC board. This pad should be connected to the internal ground planes by an array of vias.

APPLICATIONS INFORMATION

Table 3. Serial Programming Mode Register Map (PAR/SER = GND). An “X” indicates an unused bit.

REGISTER A0: RESET REGISTER (ADDRESS 00h) WRITE-ONLY

D7	D6	D5	D4	D3	D2	D1	D0
RESET	X	X	X	X	X	X	X

Bit 7 **RESET** Software Reset Bit
 0 = Not Used
 1 = Software Reset. All mode control registers are reset to 00h. This bit is automatically set back to zero after the reset is complete.

Bits 6-0 Unused bit.

REGISTER A1: POWER-DOWN REGISTER (ADDRESS 01h)

D7	D6	D5	D4	D3	D2	D1	D0
X	X	X	X	SLEEP	NAP	0	0

Bits 7-4 Unused, these bits are read back as 0.

Bit 3 **SLEEP**
 0 = Normal Operation
 1 = Power Down Entire ADC

Bit 2 **NAP**
 0 = Normal Mode
 1 = Low Power Mode

Bit 1-0 Must be set to 0.

REGISTER A2: TIMING REGISTER (ADDRESS 02h)

D7	D6	D5	D4	D3	D2	D1	D0
X	X	X	X	CLKINV	CLKPHASE1	CLKPHASE0	DCS

Bits 7-4 Unused, these bits are read back as 0.

Bit 3 **CLKINV** Output Clock Invert Bit
 0 = Normal CLKOUT Polarity (as shown in the Timing Diagrams)
 1 = Inverted CLKOUT Polarity

Bits 2-1 **CLKPHASE1:CLKPHASE0** Output Clock Phase Delay Bits
 00 = No CLKOUT Delay (as shown in the Timing Diagrams)
 01 = CLKOUT⁺/CLKOUT⁻ delayed by 45° (Clock Period • 1/8)
 10 = CLKOUT⁺/CLKOUT⁻ delayed by 90° (Clock Period • 1/4)
 11 = CLKOUT⁺/CLKOUT⁻ delayed by 135° (Clock Period • 3/8)
 Note: If the CLKOUT phase delay feature is used, the clock duty cycle stabilizer must also be turned on.

Bit 0 **DCS** Clock Duty Cycle Stabilizer Bit
 0 = Clock Duty Cycle Stabilizer Off
 1 = Clock Duty Cycle Stabilizer On

APPLICATIONS INFORMATION

REGISTER A3: OUTPUT MODE REGISTER (ADDRESS 03h)

D7	D6	D5	D4	D3	D2	D1	D0
X	X	X	ILVDS2	ILVDS1	ILVDS0	TERMON	OUTOFF

Bits 7-5 Unused, these bits are read back as 0.

Bits 4-2 **ILVDS2:ILVDS0** LVDS Output Current Bits
 000 = 3.5mA LVDS Output Driver Current
 001 = 4.0mA LVDS Output Driver Current
 010 = 4.5mA LVDS Output Driver Current
 011 = Not Used
 100 = 3.0mA LVDS Output Driver Current
 101 = 2.5mA LVDS Output Driver Current
 110 = 2.1mA LVDS Output Driver Current
 111 = 1.75mA LVDS Output Driver Current

Bit 1 **TERMON** LVDS Internal Termination Bit
 0 = Internal Termination Off
 1 = Internal Termination On. LVDS output driver current is 2× the current set by ILVDS2:ILVDS0

Bit 0 **OUTOFF** Digital Output Mode Control Bits
 0 = LVDS DDR
 1 = LVDS Tristate (High Impedance)

REGISTER A4: DATA FORMAT REGISTER (ADDRESS 04h)

D7	D6	D5	D4	D3	D2	D1	D0
OUTTEST2	OUTTEST1	OUTTEST0	ABP	0	DTESTON	RAND	TWOSCOMP

Bits 7-5 **OUTTEST2:OUTTEST0** Digital Output Test Pattern Bits
 000 = All Digital Outputs = 0
 001 = All Digital Outputs = 1
 010 = Alternating Output Pattern. OF, D11-D0 alternate between 00000 0000 0000 and 11111 1111 1111
 100 = Checkerboard Output Pattern. OF, D11-D0 alternate between 01010 1010 1010 and 10101 0101 0101

Bit 4 **ABP** Alternate Bit Polarity Mode Control Bit
 0 = Alternate Bit Polarity Mode Off
 1 = Alternate Bit Polarity Mode On

Bit 3 Must be set to 0.

Bit 2 **DTESTON** Enable digital patterns (Bits 7-5)
 0 = Normal Mode
 1 = Enable the Digital Output Test Patterns

Bit 1 **RAND** Data Output Randomizer Mode Control Bit
 0 = Data Output Randomizer Mode Off
 1 = Data Output Randomizer Mode On

Bit 0 **TWOSCOMP** Two's Complement Mode Control Bit
 0 = Offset Binary Data Format
 1 = Two's Complement Data Format

APPLICATIONS INFORMATION

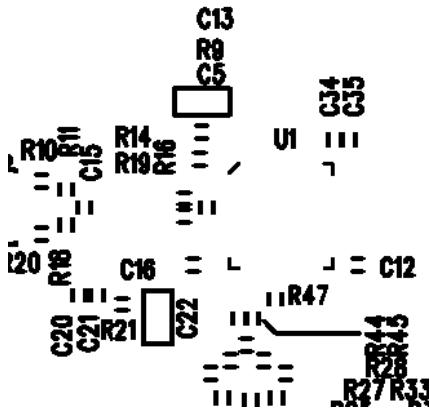

Silkscreen Top

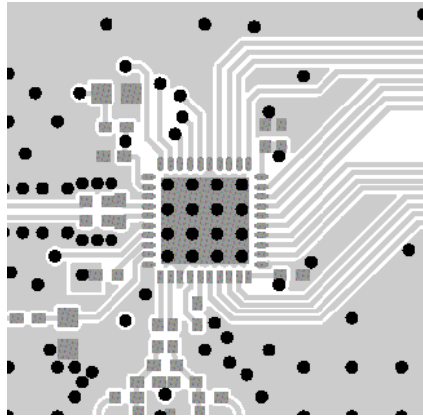

Inner Layer 1

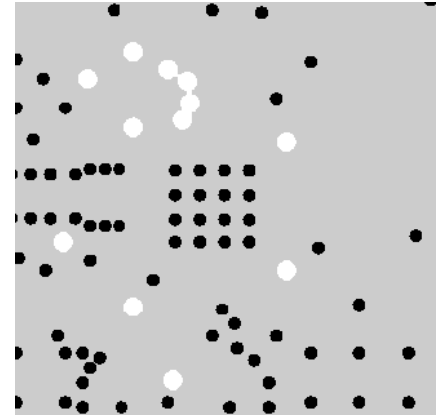

Inner Layer 2

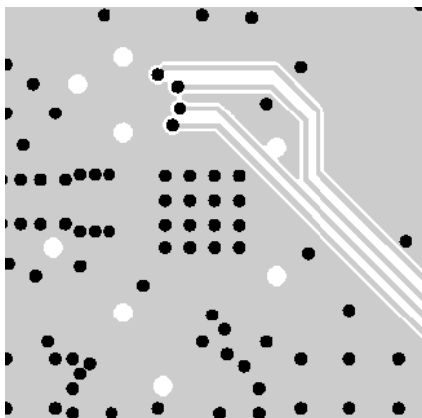

Inner Layer 3

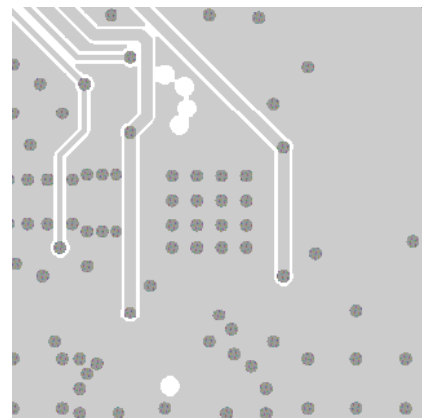

Inner Layer 4

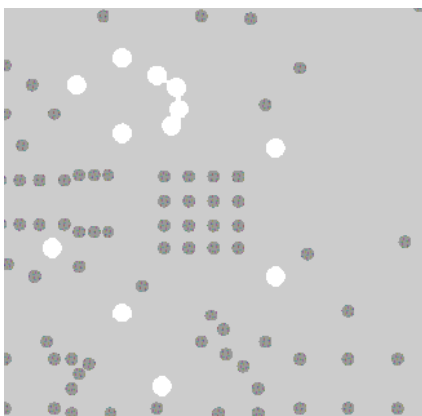

Inner Layer 5

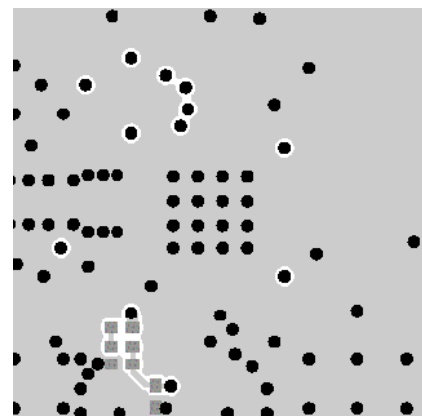

Bottom Layer

TYPICAL APPLICATIONS

LTC2152-12 Schematic

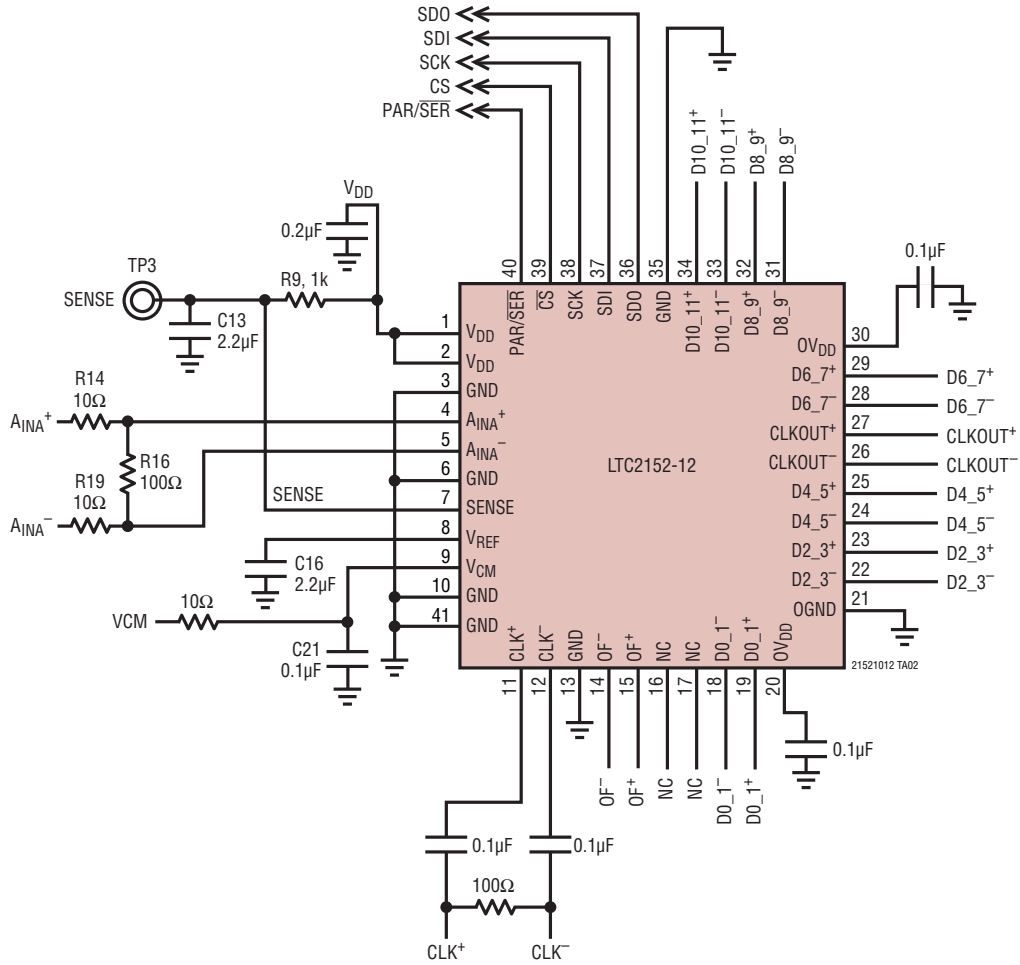

TYPICAL APPLICATION

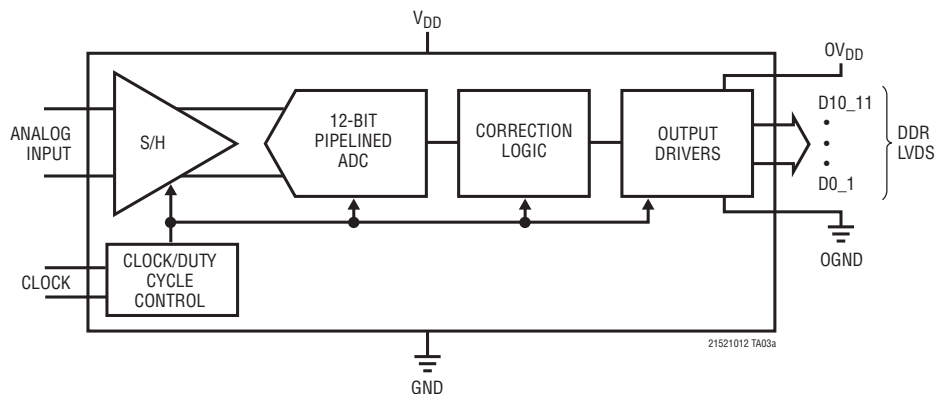

LTC2152-12: 32K Point 2-Tone FFT,
 $f_{IN} = 71\text{MHz}$ and 69MHz , 250Msps

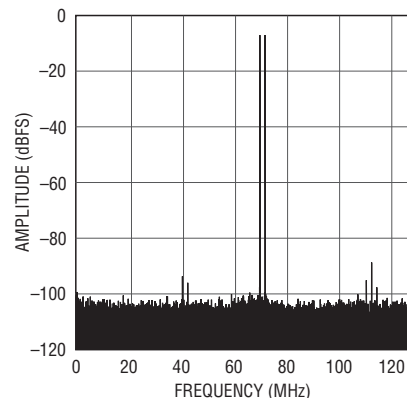

RELATED PARTS

PART NUMBER	DESCRIPTION	COMMENTS
ADCs		
LTC2208	16-Bit, 130Msps, 3.3V ADC, LVDS Outputs	1250mW, 77.7dB SNR, 100dB SFDR, 64-Lead QFN Package
LTC2157-14/LTC2156-14/ LTC2155-14	14-Bit, 250Msps/210Msps/170Msps, 1.8V Dual ADC, DDR LVDS Outputs	650mW/616mW/567mW, 70dB SNR, 90dB SFDR, 64-Lead QFN Package
LTC2152-14/LTC2151-14/ LTC2150-14	14-Bit, 250Msps/210Msps/170Msps, 1.8V Dual ADC, DDR LVDS Outputs	356mW/338mW/313mW, 70dB SNR, 90dB SFDR, 40-Lead QFN Package
LTC2262-14	14-Bit, 150Msps 1.8V ADC, Ultralow Power	149mW, 72.8dB SNR, 88dB SFDR, DDR LVDS/DDR CMOS/CMOS Outputs, 40-Lead QFN Package
RF Mixers/Demodulators		
LT [®] 5517	40MHz to 900MHz Direct Conversion Quadrature Demodulator	High IIP3: 21dBm at 800MHz, Integrated LO Quadrature Generator
LT5527	400MHz to 3.7GHz High Linearity Downconverting Mixer	24.5dBm IIP3 at 900MHz, 23.5dBm IIP3 at 3.5GHz, NF = 12.5dB, 50Ω Single-Ended RF and LO Ports
LT5575	800MHz to 2.7GHz Direct Conversion Quadrature Demodulator	High IIP3: 28dBm at 900MHz, Integrated LO Quadrature Generator, Integrated RF and LO Transformer
Amplifiers/Filters		
LTC6409	10GHz GBW, 1.1nV/ $\sqrt{\text{Hz}}$ Differential Amplifier/ ADC Driver	88dB SFDR at 100MHz, Input Range Includes Ground 52mA Supply Current, 3mm × 2mm QFN Package
LTC6412	800MHz, 31dB Range, Analog-Controlled Variable Gain Amplifier	Continuously Adjustable Gain Control, 35dBm OIP3 at 240MHz, 10dB Noise Figure, 4mm × 4mm QFN-24 Package
LTC6420-20	1.8GHz Dual Low Noise, Low Distortion Differential ADC Drivers for 300MHz IF	Fixed Gain 10V/V, 1nV/ $\sqrt{\text{Hz}}$ Total Input Noise, 80mA Supply Current per Amplifier, 3mm × 4mm QFN-20 Package
Receiver Subsystems		
LTM9002	14-Bit Dual Channel IF/Baseband Receiver Subsystem	Integrated High Speed ADC, Passive Filters and Fixed Gain Differential Amplifiers
LTM9003	12-Bit Digital Pre-Distortion Receiver	Integrated 12-Bit ADC Down-Converter Mixer with 0.4GHz to 3.8GHz Input Frequency Range

21521012f