

DESCRIPTION

The RH1014M is the first precision quad operational amplifier which directly upgrades designs in the industry standard 8-pin DIP LM124/LM148/OP-11/5156 pin configuration. Low offset voltage (300 μ V max), low drift ($\leq 2.5\mu$ V/ $^{\circ}$ C), low offset current (≤ 1.5 nA), and high gain (1.2 million min) combine to make the RH1014M four truly precision amplifiers in one package.

The wafer lots are processed to Linear Technology's in-house Class S flow to yield circuits usable in stringent military applications.

ABSOLUTE MAXIMUM RATINGS

| | |
|--|------------------------------------|
| Supply Voltage | ± 22 V |
| Differential Input Voltage | ± 30 V |
| Input Voltage | Equal to Positive Supply Voltage |
| | 5V Below Negative Supply Voltage |
| Output Short-Circuit Duration | Indefinite |
| Operating Temperature Range | -55° C to 125° C |
| Storage Temperature Range | -65° C to 150° C |
| Lead Temperature (Soldering, 10 sec) | 300° C |

 LTC and LT are registered trademarks of Linear Technology Corporation.

BURN-IN CIRCUIT

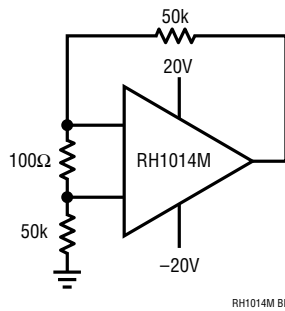

PACKAGE INFORMATION

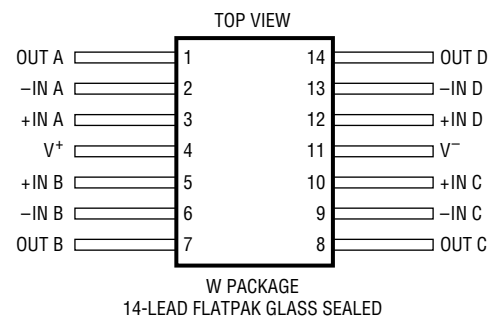
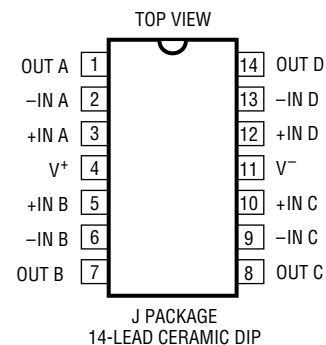

TABLE 1: ELECTRICAL CHARACTERISTICS (Pre-Irradiation) $V_S = \pm 15V$, $V_{CM} = 0V$, unless otherwise noted.

| SYMBOL | PARAMETER | CONDITIONS | NOTES | $T_A = 25^\circ C$ | | | SUB-GROUP | $-55^\circ C \leq T_A \leq 125^\circ C$ | | | SUB-GROUP | UNITS |
|-------------------------------------|----------------------------------|---|-------|--------------------|------------|------|-----------|---|------------|------|------------------|----------------|
| | | | | MIN | TYP | MAX | | MIN | TYP | MAX | | |
| V_{OS} | Input Offset Voltage | $V_{CM} = 0.1V$, $T_A = 125^\circ C$ | 1 | | | 300 | 1 | | | 550 | 2,3 | μV |
| | | | 2 | | | 450 | 1 | | | 750 | 3 | μV |
| | | | 2 | | | | | | | 750 | 2 | μV |
| $\frac{\Delta V_{OS}}{\Delta Temp}$ | Average Tempco of Offset Voltage | | 1 | | | | | | 2.5 | | $\mu V/^\circ C$ | |
| $\frac{\Delta V_{OS}}{\Delta Time}$ | Long Term V_{OS} Stability | | | | 0.5 | | | | | | $\mu V/Mo$ | |
| I_{OS} | Input Offset Current | | 1 | | | 10 | 1 | | | 20 | 2,3 | nA |
| | | | 2 | | | 10 | 1 | | | 20 | 2,3 | nA |
| I_B | Input Bias Current | | 1 | | | 30 | 1 | | | 45 | 2,3 | nA |
| | | | 2 | | | 50 | 1 | | | 120 | 2,3 | nA |
| e_n | Input Noise Voltage | 0.1Hz to 10Hz | | | 0.55 | | | | | | | μV_{P-P} |
| | Input Noise Voltage | $f_0 = 10Hz$ | | | 24 | | | | | | | nV/\sqrt{Hz} |
| | Density | $f_0 = 1000Hz$ | | | 22 | | | | | | | nV/\sqrt{Hz} |
| i_n | Input Noise Current Density | $f_0 = 10Hz$ | | | 0.07 | | | | | | | pA/\sqrt{Hz} |
| R_{IN} | Input Resistance | Differential | 1 | | 70 | | | | | | | $M\Omega$ |
| | | Common Mode | | | 4 | | | | | | | $G\Omega$ |
| A_{VOL} | Large-Signal Voltage Gain | $V_0 = \pm 10V$, $R_L \geq 2k$ | | | 1.2 | | 4 | | 0.25 | | 5,6 | $V/\mu V$ |
| | | $V_0 = \pm 10V$, $R_L \geq 600\Omega$ | | | 0.5 | | 4 | | | | | $V/\mu V$ |
| | | $V_0 = 5mV$ to $4V$, $R_L = 500\Omega$ | 2 | | 1 | | | | | | | $V/\mu V$ |
| | Input Voltage Range | | 1 | | 13.5 | | | | | | | V |
| | | | 1 | | -15.0 | | | | | | | V |
| | | | 1,2 | | 3.5 | | | | | | | V |
| | | | 1,2 | | 0 | | | | | | | V |
| CMRR | Common-Mode Rejection Ratio | $V_{CM} = 13.5V$, $-15V$ | | | 97 | | 1 | | | | | dB |
| | | $V_{CM} = 13V$, $-14.9V$ | | | | | | | 94 | | 2,3 | dB |
| PSRR | Power Supply Rejection Ratio | $V_S = \pm 2V$ to $\pm 18V$ | | | 100 | | 1 | | 97 | | 2,3 | dB |
| | Channel Separation | $V_0 = \pm 10V$, $R_L = 2k$ | | | 120 | | 1 | | | | | dB |
| V_{OUT} | Output Voltage Swing | $R_L \geq 2k$ | | | ± 12.5 | | 4 | | ± 11.5 | | 5,6 | V |
| | | Output Low, No Load | 2 | | 25 | | 4 | | | | | mV |
| | | Output Low, 600Ω to GND | 2 | | 10 | | 4 | | | 18 | 5,6 | mV |
| | | Output Low, $I_{SINK} = 1mA$ | 2 | | 350 | | 4 | | | | | mV |
| | | Output High, No Load | 2 | | 4.0 | | 4 | | | | | V |
| | | Output High, 600Ω to GND | 2 | | 3.4 | | 4 | | | 3.1 | 5,6 | V |
| SR | Slew Rate | | | | 0.2 | | 4 | | | | | $V/\mu s$ |
| I_S | Supply Current | Per Amplifier | 1 | | | 0.55 | 1 | | | 0.70 | 2,3 | mA |
| | | | 2 | | | 0.50 | 1 | | | 0.65 | 2,3 | mA |

TABLE 1A: ELECTRICAL CHARACTERISTICS (Post-Irradiation) $V_S = \pm 15V$, $V_{CM} = 0V$, $T_A = 25^\circ C$, unless otherwise noted.

| SYMBOL | PARAMETER | CONDITIONS | NOTES | 10KRAD(Si) | | 20KRAD(Si) | | 50KRAD(Si) | | 100KRAD(Si) | | 200KRAD(Si) | | UNITS |
|-----------|------------------------------|-------------------------------|-------|------------|------------|------------|------------|------------|------------|-------------|------------|-------------|------------|------------|
| | | | | MIN | MAX | MIN | MAX | MIN | MAX | MIN | MAX | MIN | MAX | |
| V_{OS} | Input Offset Voltage | | | | 450 | | 450 | | 600 | | 750 | | 900 | μV |
| | | | 2 | | 600 | | 600 | | 750 | | 900 | | | μV |
| I_{OS} | Input Offset Current | | | | 10 | | 10 | | 15 | | 20 | | 25 | nA |
| | | | 2 | | 10 | | 10 | | 15 | | 20 | | | nA |
| I_B | Input Bias Current | | | | 60 | | 75 | | 100 | | 175 | | 250 | nA |
| | | | 2 | | 80 | | 100 | | 125 | | 200 | | | nA |
| | Input Voltage Range | | 1 | 13.5 | | 13.5 | | 13.5 | | 13.5 | | 13.5 | | V |
| | | | 1 | -15.0 | | -15.0 | | -15.0 | | -15.0 | | -15.0 | | V |
| | | | 2 | 3.5 | | 3.5 | | 3.5 | | 3.5 | | | | V |
| | | | 2 | 0 | | 0 | | 0 | | 0 | | | | V |
| CMRR | Common-Mode Rejection Ratio | $V_{CM} = 13V, -15V$ | | | 97 | | 97 | | 94 | | 90 | | 86 | dB |
| PSRR | Power Supply Rejection Ratio | $V_S = \pm 10V$ to $\pm 18V$ | | | 100 | | 98 | | 94 | | 86 | | 80 | dB |
| A_{VOL} | Large-Signal Voltage Gain | $R_L \geq 10k, V_O = \pm 10V$ | | | 500 | | 200 | | 100 | | 50 | | 25 | V/mV |
| V_{OUT} | Maximum Output Voltage Swing | $R_L \geq 10k$ | | | ± 12.5 | | ± 12.5 | | ± 12.5 | | ± 12.5 | | ± 12.5 | V |
| | | | 2 | | 25 | | 30 | | 40 | | 50 | | | mV |
| | | | 2 | | 10 | | 10 | | 10 | | 10 | | | mV |
| | | | 2 | | 0.6 | | 0.8 | | 1.0 | | 1.6 | | | V |
| | | | 2 | | 4.0 | | 4.0 | | 4.0 | | 4.0 | | | V |
| | | | 2 | | 3.4 | | 3.2 | | 3.0 | | 2.8 | | | V |
| SR | Slew Rate | $R_L \geq 10k$ | | | 0.13 | | 0.12 | | 0.11 | | 0.07 | | 0.01 | V/ μs |
| I_S | Supply Current | Per Amplifier | | | 0.55 | | 0.55 | | 0.55 | | 0.55 | | 0.55 | mA |
| | | | 2 | | 0.50 | | 0.50 | | 0.50 | | 0.50 | | | mA |

Note 1: Guaranteed by design, characterization, or correlation to other tested parameters.

Note 2: Specification applies for $V_S^+ = 5V$, $V_S^- = 0V$, $V_{CM} = 0V$, $V_{OUT} = 1.4V$.

TABLE 2: ELECTRICAL TEST REQUIREMENTS

| MIL-STD-883 TEST REQUIREMENTS | SUBGROUP |
|--|--------------|
| Final Electrical Test Requirements (Method 5004) | 1*,2,3,4,5,6 |
| Group A Test Requirements (Method 5005) | 1,2,3,4,5,6 |
| Group B and D for Class S End Point Electrical Parameters (Method 5005) | 1,2,3 |

* PDA applies to subgroup 1. See PDA Test Notes.

PDA Test Notes

The PDA is specified as 5% based on failures from group A, subgroup 1, tests after cooldown as the final electrical test in accordance with method 5004 of MIL-STD-883. The verified failures of group A, subgroup 1, after burn-in divided by the total number of devices submitted for burn-in in that lot shall be used to determine the percent for the lot.

Linear Technology Corporation reserves the right to test to tighter limits than those given.

TOTAL DOSE BIAS CIRCUIT

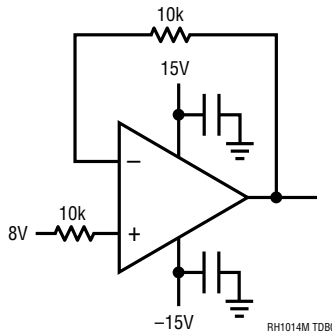

TYPICAL PERFORMANCE CHARACTERISTICS

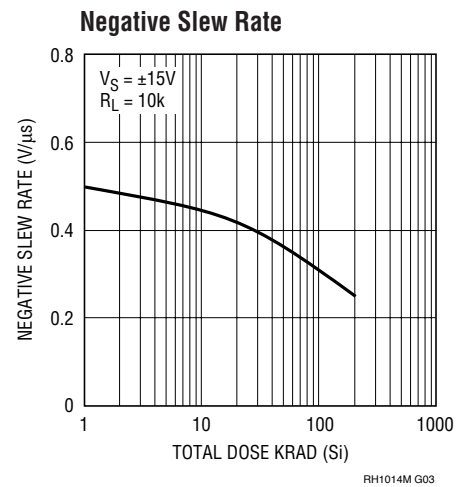
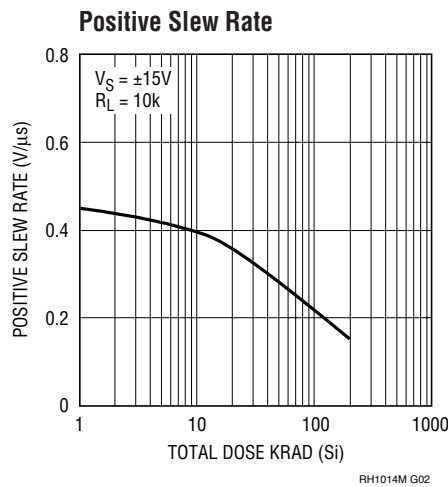
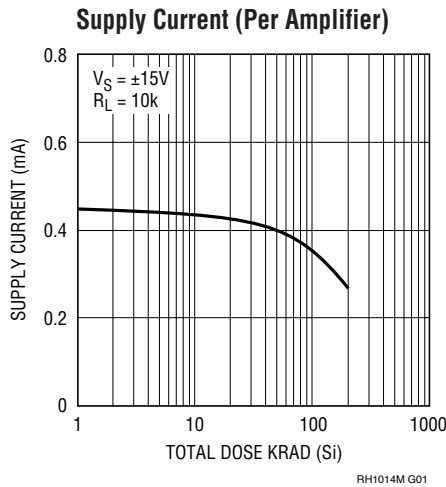

TYPICAL PERFORMANCE CHARACTERISTICS

Input Offset Voltage

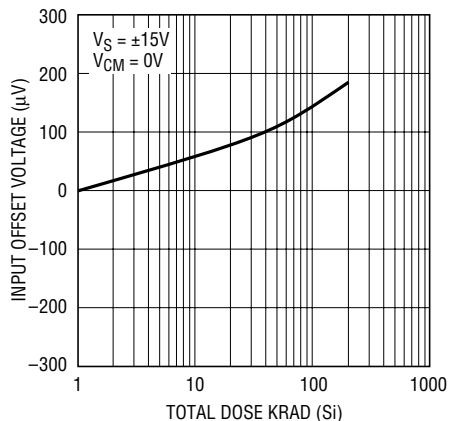

RH1014M G04

Input Bias Current

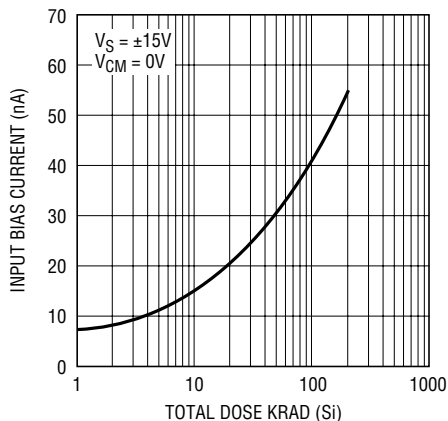

RH1014M G05

Input Offset Current

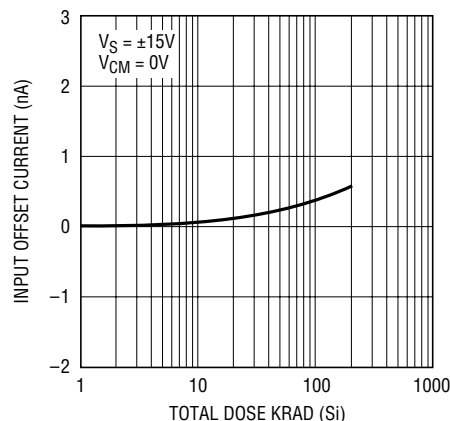

RH1014M G06

Open-Loop Gain

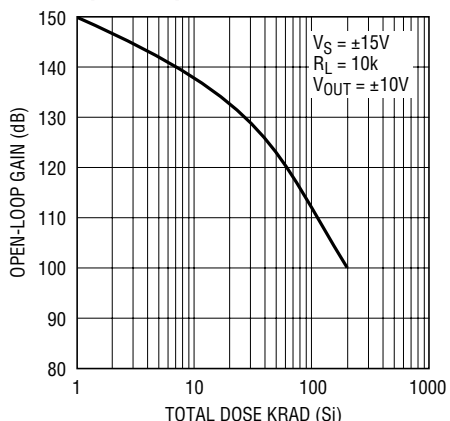

RH1014M G07

Common-Mode Rejection Ratio

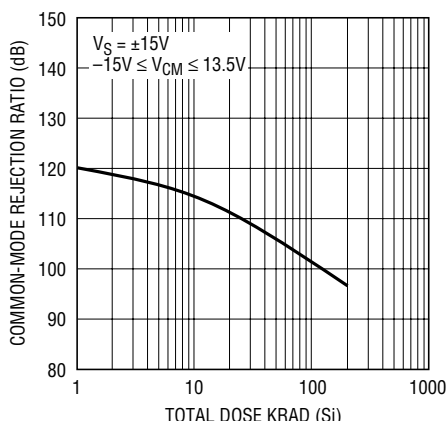

RH1014M G08

Power Supply Rejection Ratio

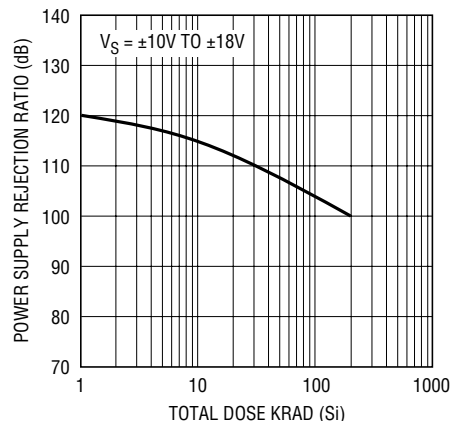

RH1014M G09

Input Noise Voltage Density

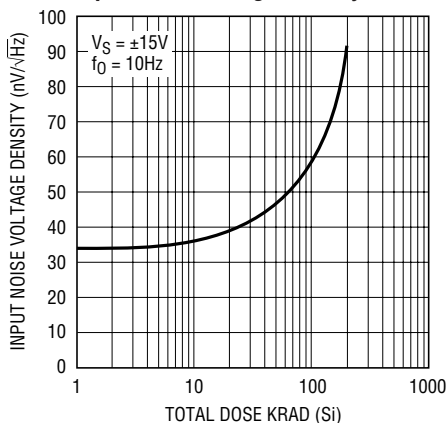

RH1014M G10

Gain Bandwidth Product

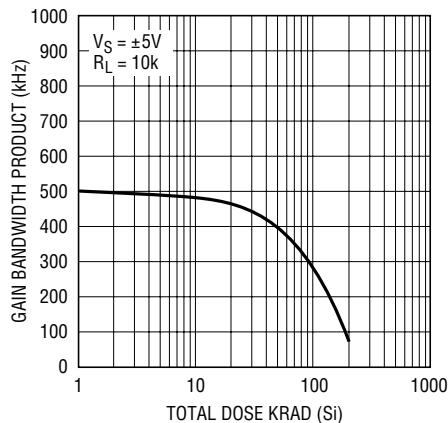

RH1014M G11

