



### Demo board user guidelines for the TS4999 filter-free stereo 2 x 2.8 W class D audio power amplifier with selectable 3D effect

#### Introduction

This application note concerns the TS4999 demonstration board, designed to evaluate the stereo class D audio differential amplifier TS4999.

This document provides:

- a brief description of the TS4999 device.
- a description of the demonstration board and all of its components.
- the layout of the demonstration board.

#### About the TS4999

The TS4999 is a fully-differential class D stereo power amplifier. It can drive up to 1.35 W into an 8  $\Omega$  load at 5 V per channel. The device has four different gain settings utilizing two discrete pins, G0 and G1.

Pop and click reduction circuitry provides low on/off switch noise while allowing the device to start within 8 ms. 3D enhancement effects are selected through one digital input pin that allows more amazing stereo audio sound.

Two standby pins (active low) allow each channel to be switched off separately.

The TS4999 is available in an 18-bump flip-chip package.

#### Key features of the TS4999

- Operating range from  $V_{CC} = 2.4$  V to 5.5 V.
- Dedicated standby mode active low for each channel.
- Output power per channel: 2.8 W at 5 V into 4  $\Omega$  with 10% THD+N or 0.7 W at 3.6 V into 8  $\Omega$  with 1% THD+N max.
- Selectable 3D sound effect.
- Four gain setting steps: 3.5, 6, 9.5 and 12 dB.
- Low current consumption.
- PSRR: 63 dB typical at 217 Hz.
- Fast start-up phase: 7.8 ms.
- Output short-circuit and thermal shutdown protection.
- Flip-chip 18-bump lead-free package.









Refer to the datasheet for complete information on the TS4999.

# 1 Description of the demonstration board

The TS4999 demonstration board is designed to evaluate the TS4999, a fully-differential class D stereo power amplifier. The TS4999 device, in a flip-chip package, is mounted on a four-layer PCB. Easily-accessible connectors on the board allow changing or driving the gain select pins (G0 and G1), the standby control pins for the left and right channels (STBL and STBR) and the 3D sound effect pin (3D).

The differential **gain** of the TS4999 can be set to 3.5, 6, 9.5, or 12 dB, depending on the logic level of the G0 pin (connected to pin 2 of S1) and G1 pin (connected to pin 2 of S2).

**Table 1. Gain settings with G0 and G1 pins**

G1	G0	S1	S2	Gain (dB)	Gain (V/V)
0	0			3.5	1.5
0	1			6	2
1	0			9.5	3
1	1			12	4

*Note:* An internal 300 k $\Omega$  (+/-20%) resistor is placed between pins G0, G1 and GND. When the pins are floating (S1 and S2 included), the gain is 3.5 dB. In full standby (left and right channels OFF), these resistors are disconnected (HiZ input).

**Table 2. Truth table for 3D effect pin and STANDBY pins**

3D	STBYL	STBYR	3D Effect	Left channel	Right channel
0	0	0	X	STDBY	STDBY
0	0	1	OFF	STDBY	ON
0	1	0	OFF	ON	STDBY
0	1	1	OFF	ON	ON
1	0	0	X	STDBY	STDBY
1	0	1	N/A	N/A	N/A
1	1	0	N/A	N/A	N/A
1	1	1	ON	ON	ON

- Note: 1 An internal 300 k $\Omega$  (+/-20%) resistor is placed between pins STBYL, STBYR, 3D and GND. When the 3D pin is floating (S5 included), the 3D effect is switched off. When pins STBYL, STBYR are floating (S3 and S4 included), the amplifier is in full standby mode. In full standby (left and right channels OFF), the internal resistors of the gain and 3D effect pins (G0, G1 and 3D) are disconnected (HiZ input).
- 2 When the 3D effect is switched on, both channels must be in operation or in shutdown mode at the same time.

The amplifier's inputs are **capacitor-coupled**, meaning that the -3 dB cut-off frequency  $F_c$  in Hz is:







$$F_c = \frac{1}{2\pi \cdot Z_{in} \cdot C_{in}}$$

with  $Z_{in}$  in  $\Omega$ ,  $C_{in}$  in Farads,  $C1 = C2$  and  $C3 = C4$ .

- 3 On the TS4999 demonstration board,  $C_{in} = C1 = C2 = C3 = C4 = 220$  nF. The input impedance  $Z_{in}$  changes with the set gain, as does  $F_c$ .

More information on component calculations is available in the TS4999 datasheet.

Table 3. Demonstration board connectors

Connector(s)	Description
P1	<b>Power connector</b> ( $V_{CC}$ and GND). Power supply voltage from 2.5 to 5.5 V.
S1, S2	<p><b>Gain setting</b> connectors: <b>S1</b> for the <b>G0</b>, <b>S2</b> for the <b>G1 pin of the TS4999</b>.</p> <p>The pins are connected as follows:</p> <ul style="list-style-type: none"> <li>– 1 to <math>V_{CC}</math></li> <li>– 2 of S1 to the G0 pin</li> <li>– 2 of S2 to the G1 pin</li> <li>– 3 to GND</li> </ul> <p>Jumper position:</p> <ul style="list-style-type: none"> <li>– logical "1": pins 1 and 2 are shorted </li> <li>– logical "0": pins 2 and 3 are shorted </li> </ul>
S3, S4	<p><b>Standby control</b> connector: <b>S3</b> for the <b>left</b> channel, <b>S4</b> for the <b>right</b> channel.</p> <p>The pins are connected as follows:</p> <ul style="list-style-type: none"> <li>– 1 to <math>V_{CC}</math></li> <li>– 2 of S3 to the STBYL pin of the TS4999</li> <li>– 2 of S4 to the STBYR pin of the TS4999</li> <li>– 3 to GND</li> </ul> <p>Jumper position:</p> <ul style="list-style-type: none"> <li>–  pins 1 and 2 are shorted, the channel is operating.</li> <li>–  pins 2 and 3 are shorted or pin 2 is floating, the channel is in standby mode.</li> </ul>
S5	<p><b>3D effect control</b> connector.</p> <p>The pins are connected as follows:</p> <ul style="list-style-type: none"> <li>– 1 to <math>V_{CC}</math></li> <li>– 2 to 3D pin of the TS4999</li> <li>– 3 to GND</li> </ul> <ul style="list-style-type: none"> <li>–  pins 1 and 2 are shorted, the 3D effect is ON.</li> <li>–  pins 2 and 3 are shorted, the 3D effect is OFF.</li> </ul>
JP1	Left channel input signal connector (GND, $L_{in+}$ , $L_{in-}$ and GND)
JP2	Right channel input signal connector (GND, $R_{in-}$ , $R_{in+}$ and GND)
JP3	Left channel output signal connector (GND, $L_{o+}$ , $L_{o-}$ and GND)
JP4	Right channel output signal connector (GND, $R_{o-}$ , $R_{o+}$ and GND)

**Caution:** When you apply the power supply through P1, **do not** invert the polarity since this will irreversibly damage the U1 amplifier.

Figure 1. Schematic diagram

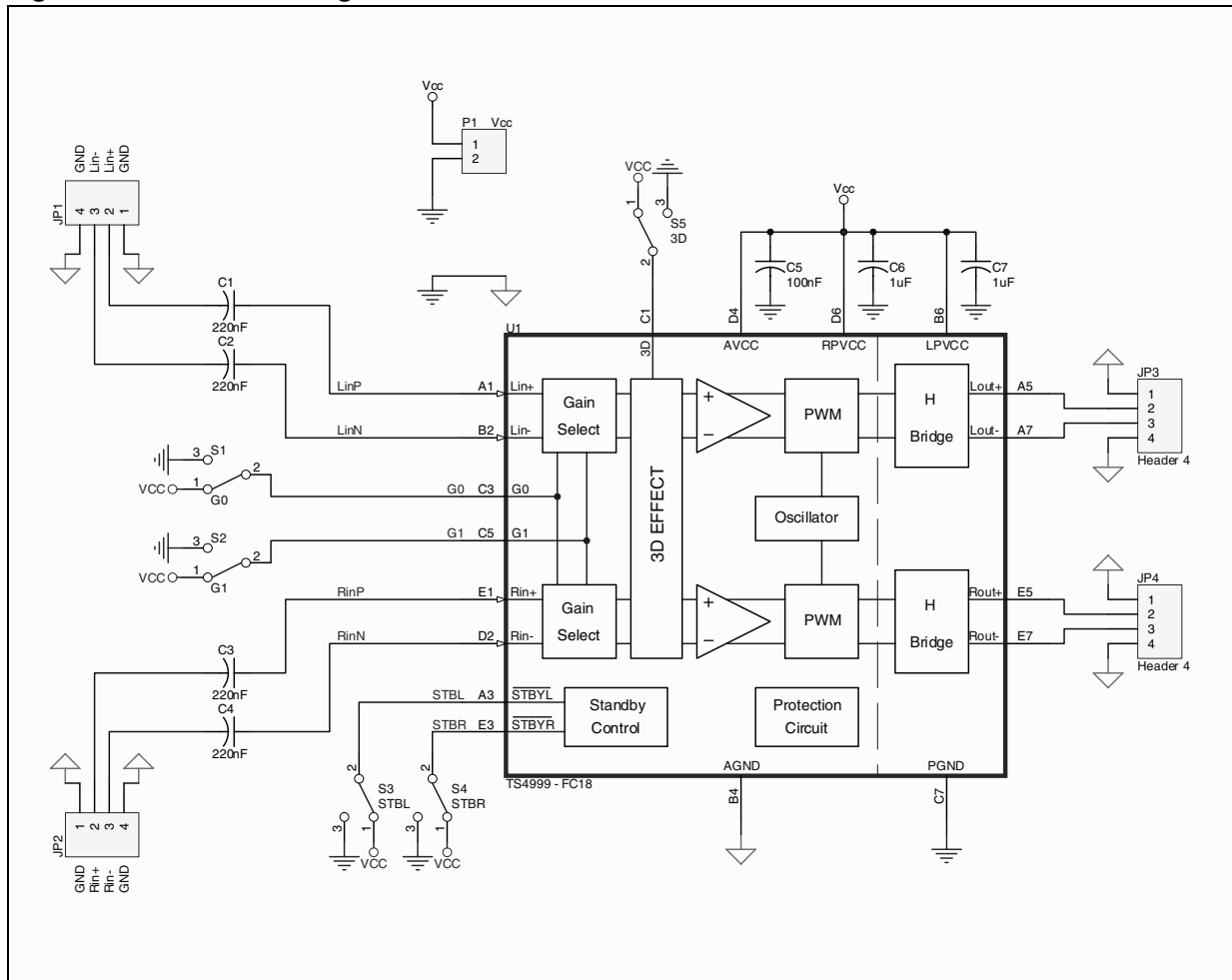

Table 4. Component list for the demonstration board

Designation	Quantity	Description
C1, C2, C3, C4	4	220 nF/16 V, SMD ceramic capacitor, 0603
C5	1	100 nF/16 V, SMD ceramic capacitor, 0603
C6, C7	1	1 μF/16 V, SMD ceramic capacitor, 0603
P1	1	2-pin header 2.54 mm pitch
S1, S2, S3, S4, S5	5	3-pin header 2.54 mm pitch
JP1, JP2, JP3, JP4	4	4-pin header 2.54 mm pitch
U1	1	TS4999 class-D audio amplifier

## 2 Demonstration board layout

The following figures depict the top view and layers of the demonstration board.

Figure 2. PCB top layer

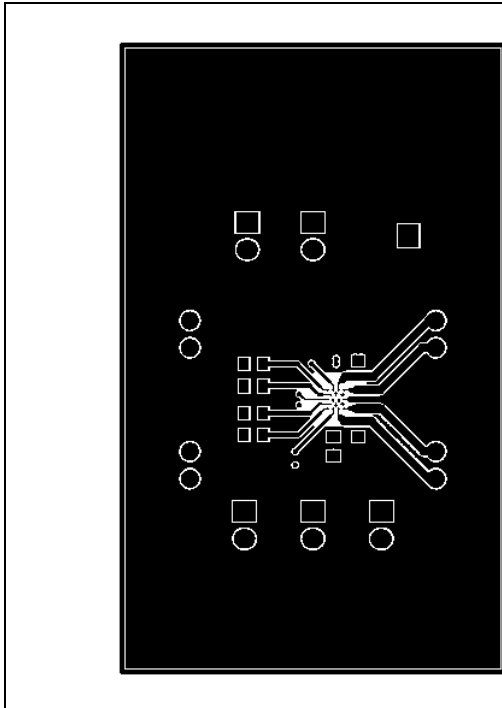

Figure 3. PCB middle layer 1

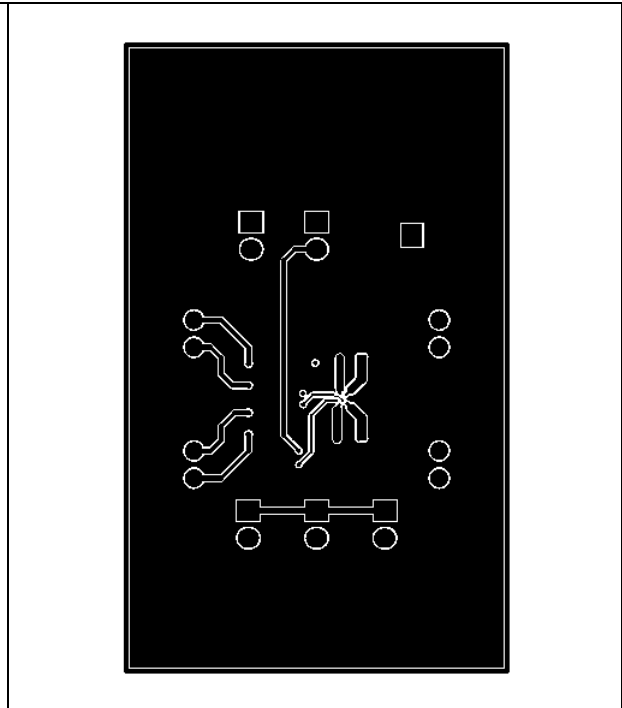

Figure 4. PCB middle layer 2

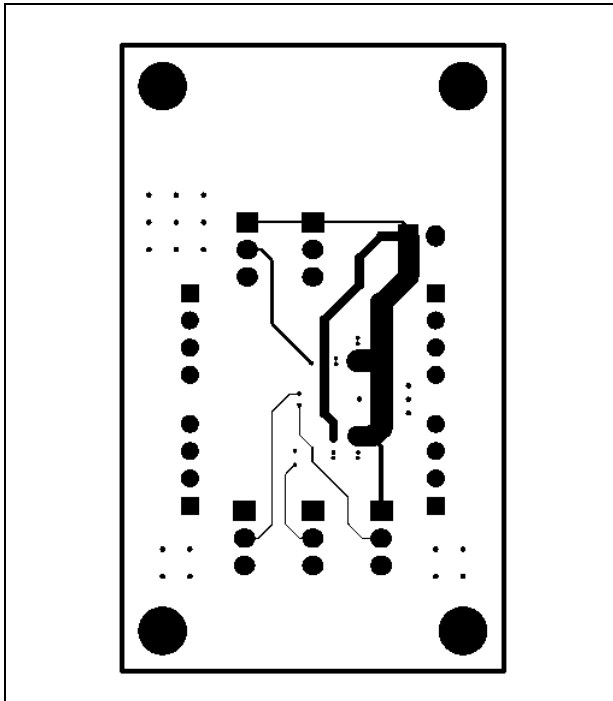

Figure 5. PCB bottom layer

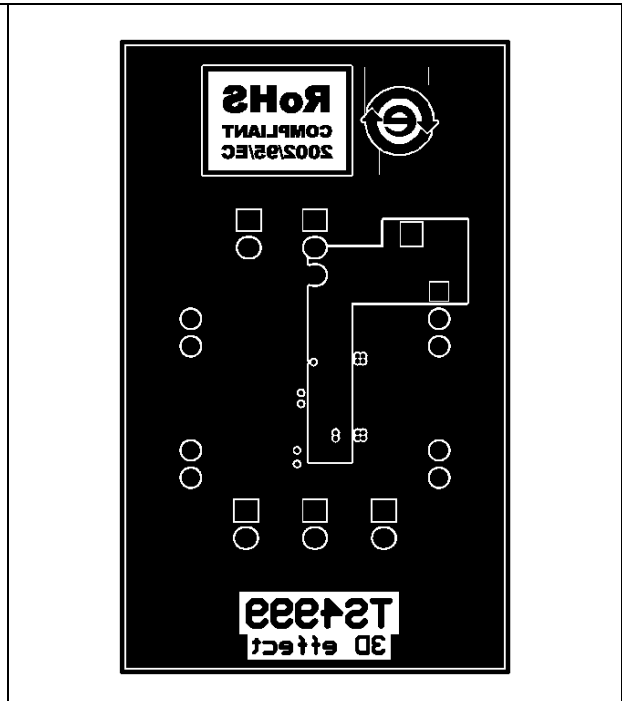
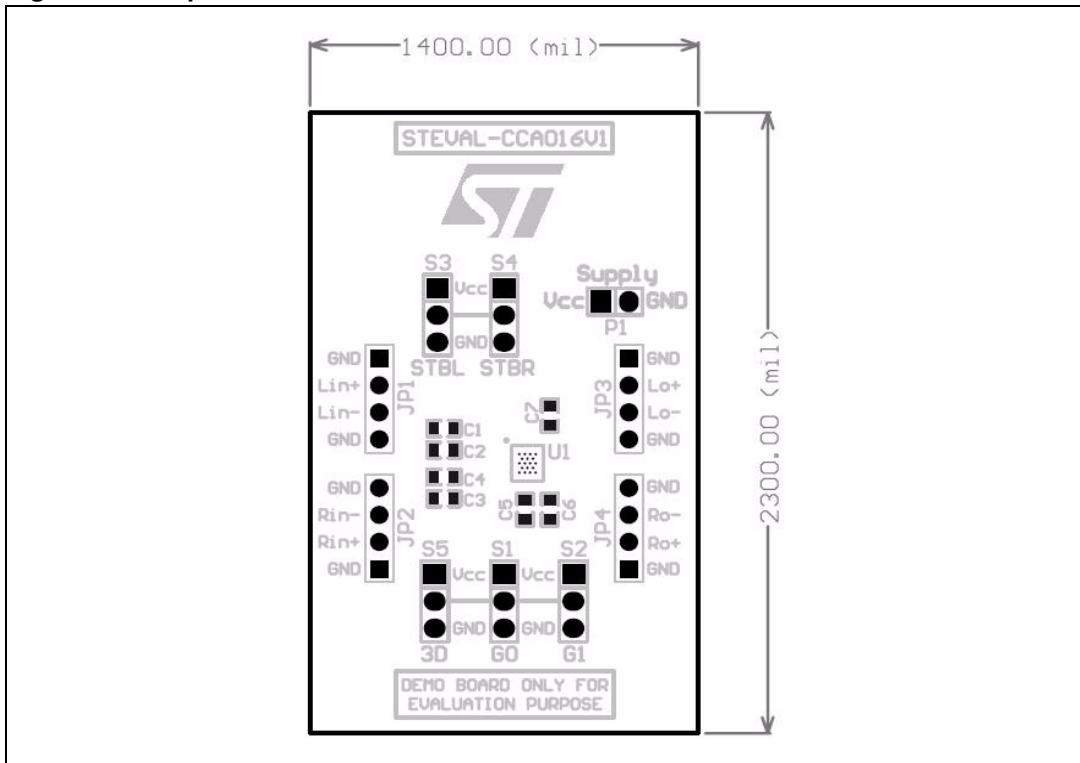

Figure 6. Top view and dimensions of the demonstration board



### 3 Conclusion

To order the board online, go to [http://www.st.com/stonline/domains/buy/buy\\_dev.htm](http://www.st.com/stonline/domains/buy/buy_dev.htm), and use the order code STEVAL-CCA016V1.



## 4 Revision history

Table 5. Document revision history

Date	Revision	Changes
27-Mar-2009	1	Initial release.

**Please Read Carefully:**

Information in this document is provided solely in connection with ST products. STMicroelectronics NV and its subsidiaries ("ST") reserve the right to make changes, corrections, modifications or improvements, to this document, and the products and services described herein at any time, without notice.

All ST products are sold pursuant to ST's terms and conditions of sale.

Purchasers are solely responsible for the choice, selection and use of the ST products and services described herein, and ST assumes no liability whatsoever relating to the choice, selection or use of the ST products and services described herein.

No license, express or implied, by estoppel or otherwise, to any intellectual property rights is granted under this document. If any part of this document refers to any third party products or services it shall not be deemed a license grant by ST for the use of such third party products or services, or any intellectual property contained therein or considered as a warranty covering the use in any manner whatsoever of such third party products or services or any intellectual property contained therein.

**UNLESS OTHERWISE SET FORTH IN ST'S TERMS AND CONDITIONS OF SALE ST DISCLAIMS ANY EXPRESS OR IMPLIED WARRANTY WITH RESPECT TO THE USE AND/OR SALE OF ST PRODUCTS INCLUDING WITHOUT LIMITATION IMPLIED WARRANTIES OF MERCHANTABILITY, FITNESS FOR A PARTICULAR PURPOSE (AND THEIR EQUIVALENTS UNDER THE LAWS OF ANY JURISDICTION), OR INFRINGEMENT OF ANY PATENT, COPYRIGHT OR OTHER INTELLECTUAL PROPERTY RIGHT.**

**UNLESS EXPRESSLY APPROVED IN WRITING BY AN AUTHORIZED ST REPRESENTATIVE, ST PRODUCTS ARE NOT RECOMMENDED, AUTHORIZED OR WARRANTED FOR USE IN MILITARY, AIR CRAFT, SPACE, LIFE SAVING, OR LIFE SUSTAINING APPLICATIONS, NOR IN PRODUCTS OR SYSTEMS WHERE FAILURE OR MALFUNCTION MAY RESULT IN PERSONAL INJURY, DEATH, OR SEVERE PROPERTY OR ENVIRONMENTAL DAMAGE. ST PRODUCTS WHICH ARE NOT SPECIFIED AS "AUTOMOTIVE GRADE" MAY ONLY BE USED IN AUTOMOTIVE APPLICATIONS AT USER'S OWN RISK.**

Resale of ST products with provisions different from the statements and/or technical features set forth in this document shall immediately void any warranty granted by ST for the ST product or service described herein and shall not create or extend in any manner whatsoever, any liability of ST.

ST and the ST logo are trademarks or registered trademarks of ST in various countries.

Information in this document supersedes and replaces all information previously supplied.

The ST logo is a registered trademark of STMicroelectronics. All other names are the property of their respective owners.

© 2009 STMicroelectronics - All rights reserved

STMicroelectronics group of companies

Australia - Belgium - Brazil - Canada - China - Czech Republic - Finland - France - Germany - Hong Kong - India - Israel - Italy - Japan - Malaysia - Malta - Morocco - Singapore - Spain - Sweden - Switzerland - United Kingdom - United States of America

[www.st.com](http://www.st.com)