



ANT2-M24LR16E

20 mm x 40 mm antenna reference board
for the M24LR16E-R Dual Interface EEPROM

Data brief

Features

- Ready-to-use printed circuit board (PCB) including
 - 20 mm x 40mm 13.56 MHz inductive antenna etched on the PCB
 - M24LR16E-R Dual Interface EEPROM
 - I²C connector
 - Energy harvesting output (V_{OUT}) with a capacitance filtering circuit
 - RF WIP/BUSY output with 20 kΩ pull-up resistor, to indicate that an RF operation is ongoing

Description

The ANT2-M24LR16E antenna reference board is a ready-to-use PCB that features an M24LR16E-R Dual Interface EEPROM IC connected to a 20 mm x 40 mm 13.56 MHz etched RF antenna on one side, and to an I²C bus on the other side.

The ANT2-M24LR16E antenna allows system designers to evaluate the M24LR16E-R



performance and capabilities, and to get started with their design.

To demonstrate the energy harvesting function, the ANT2-M24LR16E can be used in conjunction with ST DEMO-CR95HF-A demonstration board.

The application can be powered directly from the M24LR16E-R V_{OUT} pin.

The ANT2-M24LR16E Gerber files can be downloaded from <http://www.st.com>.

Figure 1. Block diagram

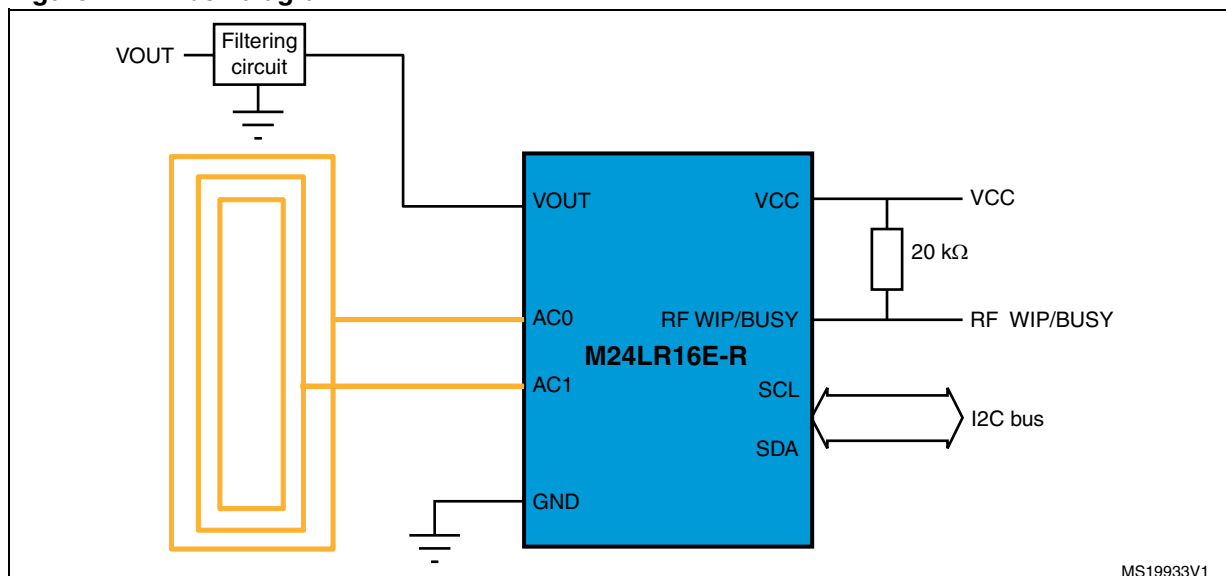

Associated firmware and PC software

The ANT2-M24LR16E board is supported by a PC software, the Dual Interface EEPROM tool software, that allows to configure and control the energy harvesting. This software is available from <http://www.st.com>.

Refer to application note AN3954 "*Developing your own Visual Basic or C/C++ application on a DEMO-CR95HF-A demonstration board*", for how to adapt the PC software for your application.

1 Revision history

Table 1. Document revision history

Date	Revision	Changes
27-Sep-2011	1	Initial release.

Please Read Carefully:

Information in this document is provided solely in connection with ST products. STMicroelectronics NV and its subsidiaries ("ST") reserve the right to make changes, corrections, modifications or improvements, to this document, and the products and services described herein at any time, without notice.

All ST products are sold pursuant to ST's terms and conditions of sale.

Purchasers are solely responsible for the choice, selection and use of the ST products and services described herein, and ST assumes no liability whatsoever relating to the choice, selection or use of the ST products and services described herein.

No license, express or implied, by estoppel or otherwise, to any intellectual property rights is granted under this document. If any part of this document refers to any third party products or services it shall not be deemed a license grant by ST for the use of such third party products or services, or any intellectual property contained therein or considered as a warranty covering the use in any manner whatsoever of such third party products or services or any intellectual property contained therein.

UNLESS OTHERWISE SET FORTH IN ST'S TERMS AND CONDITIONS OF SALE ST DISCLAIMS ANY EXPRESS OR IMPLIED WARRANTY WITH RESPECT TO THE USE AND/OR SALE OF ST PRODUCTS INCLUDING WITHOUT LIMITATION IMPLIED WARRANTIES OF MERCHANTABILITY, FITNESS FOR A PARTICULAR PURPOSE (AND THEIR EQUIVALENTS UNDER THE LAWS OF ANY JURISDICTION), OR INFRINGEMENT OF ANY PATENT, COPYRIGHT OR OTHER INTELLECTUAL PROPERTY RIGHT.

UNLESS EXPRESSLY APPROVED IN WRITING BY TWO AUTHORIZED ST REPRESENTATIVES, ST PRODUCTS ARE NOT RECOMMENDED, AUTHORIZED OR WARRANTED FOR USE IN MILITARY, AIR CRAFT, SPACE, LIFE SAVING, OR LIFE SUSTAINING APPLICATIONS, NOR IN PRODUCTS OR SYSTEMS WHERE FAILURE OR MALFUNCTION MAY RESULT IN PERSONAL INJURY, DEATH, OR SEVERE PROPERTY OR ENVIRONMENTAL DAMAGE. ST PRODUCTS WHICH ARE NOT SPECIFIED AS "AUTOMOTIVE GRADE" MAY ONLY BE USED IN AUTOMOTIVE APPLICATIONS AT USER'S OWN RISK.

Resale of ST products with provisions different from the statements and/or technical features set forth in this document shall immediately void any warranty granted by ST for the ST product or service described herein and shall not create or extend in any manner whatsoever, any liability of ST.

ST and the ST logo are trademarks or registered trademarks of ST in various countries.

Information in this document supersedes and replaces all information previously supplied.

The ST logo is a registered trademark of STMicroelectronics. All other names are the property of their respective owners.

© 2011 STMicroelectronics - All rights reserved

STMicroelectronics group of companies

Australia - Belgium - Brazil - Canada - China - Czech Republic - Finland - France - Germany - Hong Kong - India - Israel - Italy - Japan - Malaysia - Malta - Morocco - Philippines - Singapore - Spain - Sweden - Switzerland - United Kingdom - United States of America

www.st.com