

Daughter Card ID : 0x0A

MALE_CON.

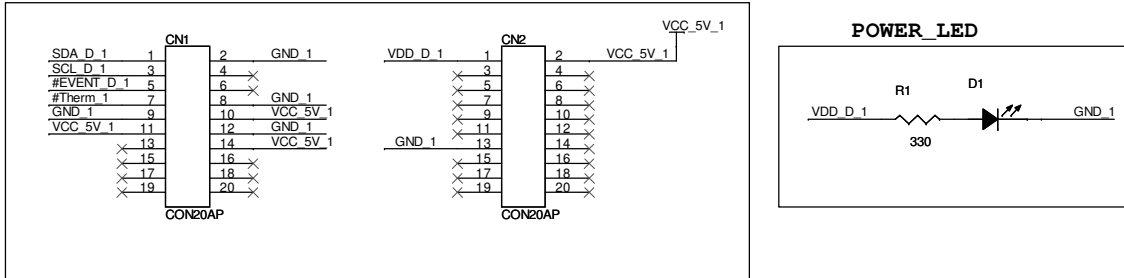

STTS751xWB3F

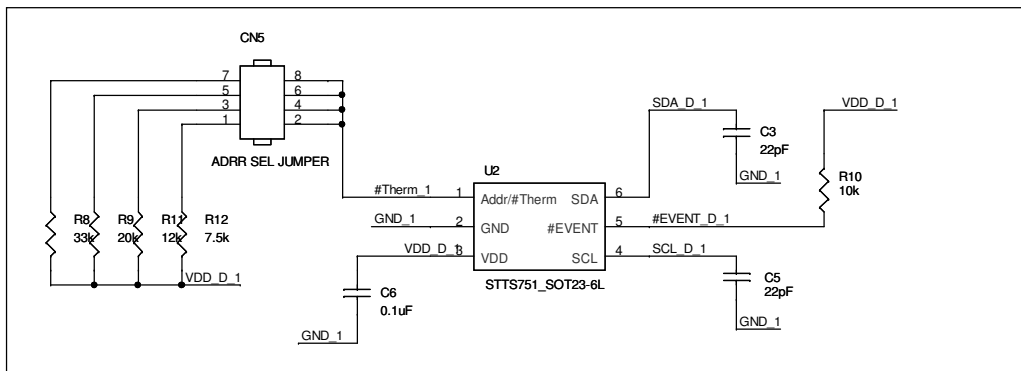

STMicroelectronics and/or its licensors do not warrant the accuracy or completeness of this specification or any information contained therein. STMicroelectronics and/or its licensors do not warrant that this design will meet the specifications, will be suitable for your application or fit for any particular purpose, or will operate in an implementation. STMicroelectronics and/or its licensors do not warrant that the design is production worthy. You should completely validate and test your design implementation to confirm the system functionality for your application.

www.st.com		
Title		
MDTS DAUGHTER CARDS		
Size	Document Number	Rev
	STEVAL-IFS017V5	1
Date:	Tuesday, October 04, 2011	Sheet 1 of 1