

Sub-GHz transceiver development kit based on the SPIRIT1 (169 MHz band)

Data brief

Features

- 2 SPIRIT1 low power, sub-GHz RF transceiver daughterboards tuned for the 169 MHz band
- 2 STM32L microcontroller-based motherboards
- Suitable for wireless M-BUS systems
- Associated SPIRIT1 software development kit with documentation, STM32L firmware and GUI
- Debug connector
- USB interface
- Modulation schemes: 2-FSK, GFSK, MSK, GMSK, OOK, and ASK
- Air data rate from 1 to 500 kbps
- Very low power consumption (9 mA RX and 21 mA TX at +11 dBm)
- Excellent performance of receiver sensitivity (up to -120 dBm)
- Low duty cycle RX/TX operation mode
- Automatic acknowledgement, retransmission, and timeout protocol engine
- AES 128-bit encryption co-processor
- SPI interface for microcontroller
- RoHS compliant

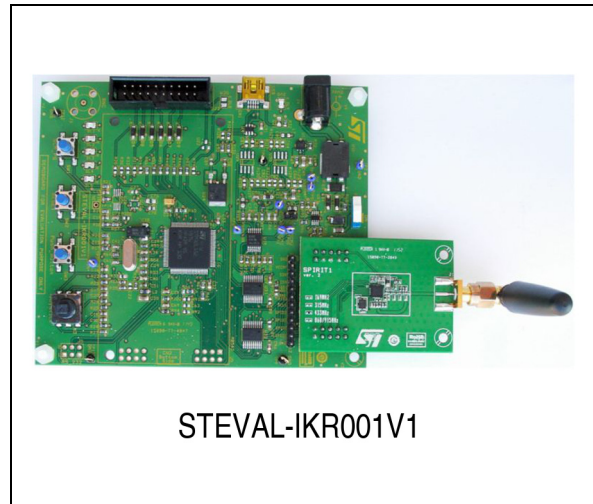

Description

The STEVAL-IKR001V1 development kit includes 2 RF daughterboards based on the SPIRIT1 low power, sub-GHz low data rate transceiver suitable for ISM bands and wireless M-BUS, and 2 motherboards based on the STM32L low power microcontroller to control the daughterboards.

Each motherboard features a USB connector for PC GUI interaction and firmware updates. A JTAG connector allows the development of specific firmware on the microcontroller.

1 Schematic diagram

Figure 1. Schematic diagram

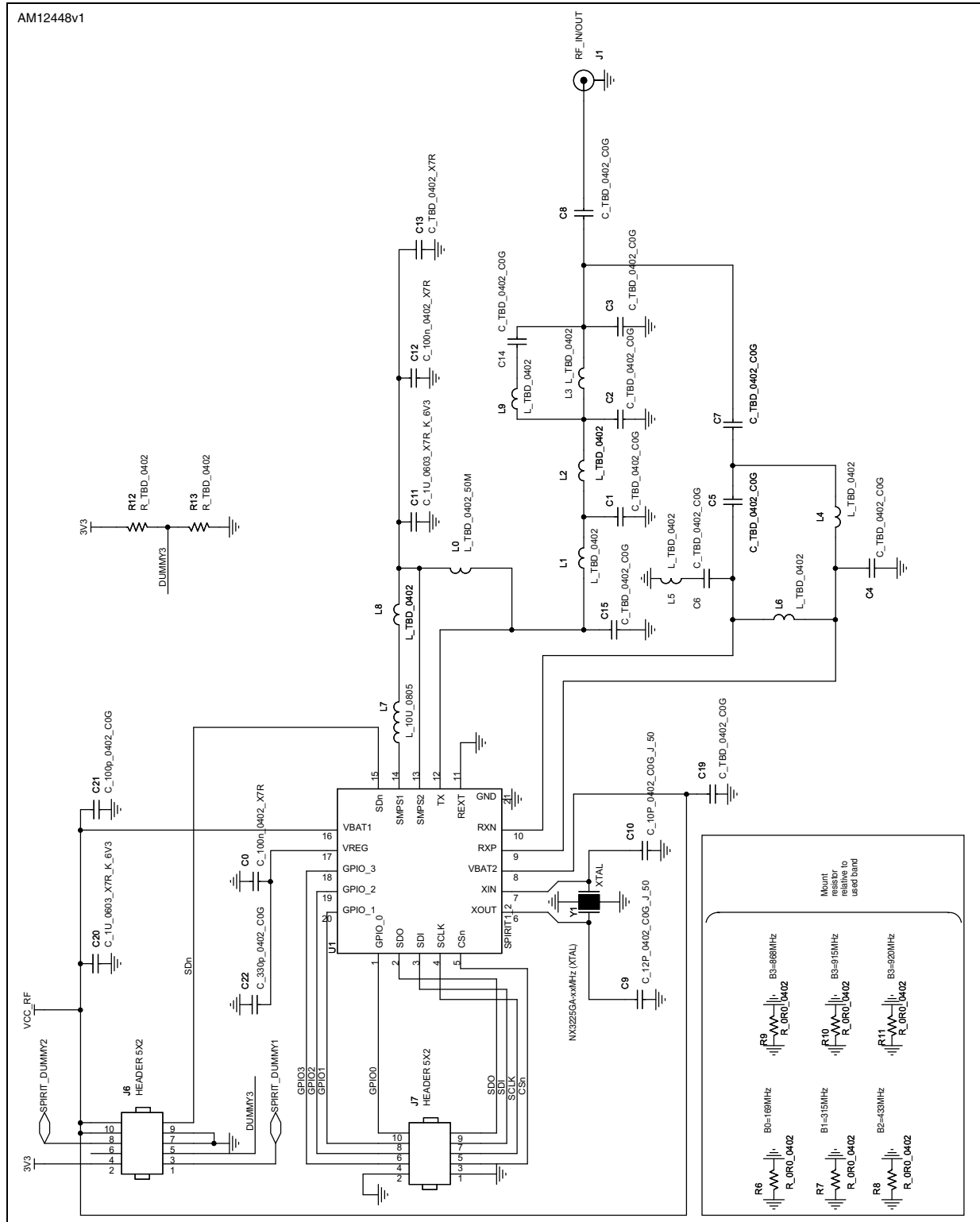

2 Revision history

Table 1. Document revision history

Date	Revision	Changes
04-Jul-2012	1	Initial release.
01-Aug-2012	2	Updated the <i>Features</i> and <i>Description</i> on the cover page

Please Read Carefully:

Information in this document is provided solely in connection with ST products. STMicroelectronics NV and its subsidiaries ("ST") reserve the right to make changes, corrections, modifications or improvements, to this document, and the products and services described herein at any time, without notice.

All ST products are sold pursuant to ST's terms and conditions of sale.

Purchasers are solely responsible for the choice, selection and use of the ST products and services described herein, and ST assumes no liability whatsoever relating to the choice, selection or use of the ST products and services described herein.

No license, express or implied, by estoppel or otherwise, to any intellectual property rights is granted under this document. If any part of this document refers to any third party products or services it shall not be deemed a license grant by ST for the use of such third party products or services, or any intellectual property contained therein or considered as a warranty covering the use in any manner whatsoever of such third party products or services or any intellectual property contained therein.

UNLESS OTHERWISE SET FORTH IN ST'S TERMS AND CONDITIONS OF SALE ST DISCLAIMS ANY EXPRESS OR IMPLIED WARRANTY WITH RESPECT TO THE USE AND/OR SALE OF ST PRODUCTS INCLUDING WITHOUT LIMITATION IMPLIED WARRANTIES OF MERCHANTABILITY, FITNESS FOR A PARTICULAR PURPOSE (AND THEIR EQUIVALENTS UNDER THE LAWS OF ANY JURISDICTION), OR INFRINGEMENT OF ANY PATENT, COPYRIGHT OR OTHER INTELLECTUAL PROPERTY RIGHT.

UNLESS EXPRESSLY APPROVED IN WRITING BY TWO AUTHORIZED ST REPRESENTATIVES, ST PRODUCTS ARE NOT RECOMMENDED, AUTHORIZED OR WARRANTED FOR USE IN MILITARY, AIR CRAFT, SPACE, LIFE SAVING, OR LIFE SUSTAINING APPLICATIONS, NOR IN PRODUCTS OR SYSTEMS WHERE FAILURE OR MALFUNCTION MAY RESULT IN PERSONAL INJURY, DEATH, OR SEVERE PROPERTY OR ENVIRONMENTAL DAMAGE. ST PRODUCTS WHICH ARE NOT SPECIFIED AS "AUTOMOTIVE GRADE" MAY ONLY BE USED IN AUTOMOTIVE APPLICATIONS AT USER'S OWN RISK.

Resale of ST products with provisions different from the statements and/or technical features set forth in this document shall immediately void any warranty granted by ST for the ST product or service described herein and shall not create or extend in any manner whatsoever, any liability of ST.

ST and the ST logo are trademarks or registered trademarks of ST in various countries.

Information in this document supersedes and replaces all information previously supplied.

The ST logo is a registered trademark of STMicroelectronics. All other names are the property of their respective owners.

© 2012 STMicroelectronics - All rights reserved

STMicroelectronics group of companies

Australia - Belgium - Brazil - Canada - China - Czech Republic - Finland - France - Germany - Hong Kong - India - Israel - Italy - Japan - Malaysia - Malta - Morocco - Philippines - Singapore - Spain - Sweden - Switzerland - United Kingdom - United States of America

www.st.com