

STEVAL-ISA046V1 SCHEMATIC

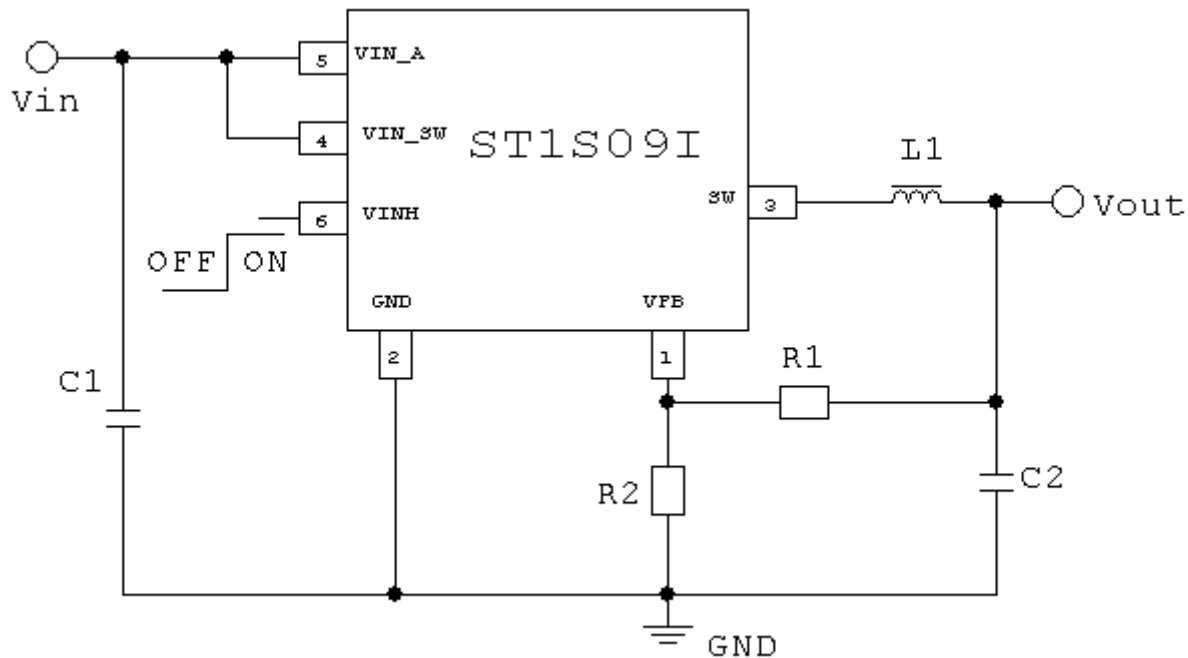

www.BDTIC.com/ST