

STEVAL-ISA047V2 SCHEMATIC

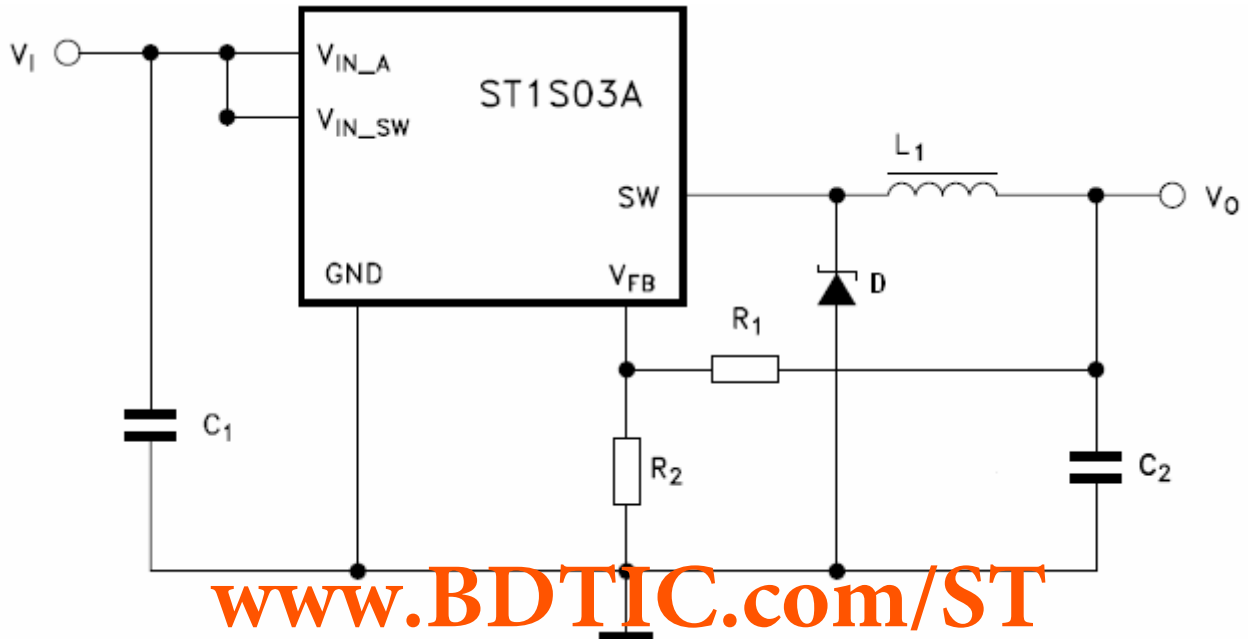

www.BDTIC.com/ST