

UltraFast™ 7ns Response Time 15GHz RF Power Detector with Comparator

DESCRIPTION

The LTC®5564 is a precision, RF power detector for applications in the 600MHz to 15GHz frequency range. The LTC5564 operates with input power levels from -24dBm to 16dBm.

A temperature compensated Schottky diode peak detector, gain-selectable operational amplifier, and fast comparator are combined in a small 16-lead 3mm × 3mm QFN package.

The RF input signal is peak detected and then sensed by both a comparator and amplifier. The comparator provides a 9ns response time to input levels exceeding V_{REF} along with a latch enable/disable function. The gain selectable operational amplifier provides a 350V/μs slew rate and 75MHz of demodulation bandwidth to the analog output.

V_{OUTADJ} and V_{REF} pins allow for the adjustment of V_{OUT} offset and V_{COMP} switch point voltages, respectively.

LT, LT, LTC, LTM, Linear Technology and the Linear Logo are registered trademarks and UltraFast is a trademark of Linear Technology Corporation. All other trademarks are the property of their respective owners.

†Higher frequency operation is achievable with reduced performance. Consult the factory for more information.

FEATURES

- Temperature Compensated Schottky RF Peak Detector
- Wide Input Frequency Range: 600MHz to 15GHz†
- Wide Input Power Range: -24dBm to 16dBm
- 7ns Typical Response Time
- 75MHz Demodulation Bandwidth
- Programmable Gain Settings for Improved Sensitivity
- Adjustable Amplifier Output Offset Voltage
- High Speed Comparator with Latch Enable: 9ns Typical Response Time
- 16-Lead 3mm × 3mm QFN Package

APPLICATIONS

- RF Signal Presence Detectors for: 802.11a, 802.11b, 802.11g, 802.15, Optical Data Links, Wireless Data Modems, Wireless and Cable Infrastructure
- 5.8GHz ISM Band Radios
- MMDS Microwave Links
- PA Power Supply Envelope Tracking Control
- Fast Alarm
- RF Power Monitor
- Envelope Detector
- Ultra-Wideband Radio
- Radar Detector

TYPICAL APPLICATION

Demo Board Schematic Optimized for 15GHz

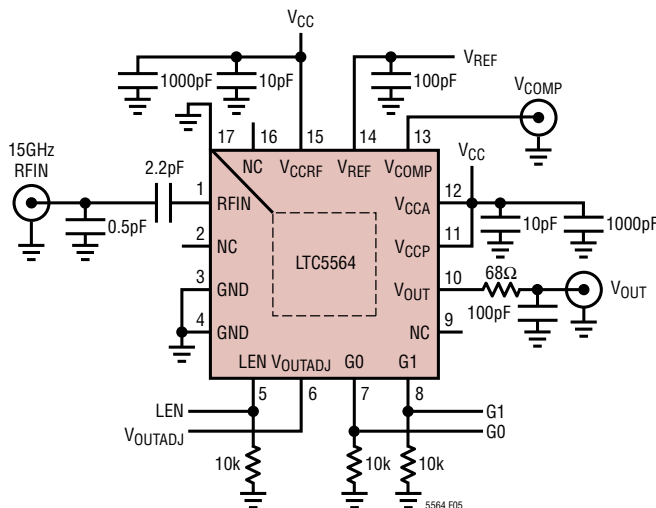

V_{OUT} vs Input Power 2.7GHz

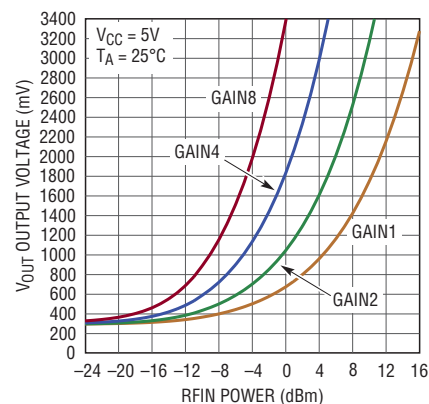

5564 TA01b

ABSOLUTE MAXIMUM RATINGS

(Note 1)

Supply Voltages

$V_{CCRF} = V_{CCA} = V_{CCP} \dots \dots \dots 5.8V$

RFIN Voltage for $V_{CCRF} \leq 5.5V \dots \dots \dots (V_{CCRF} \pm 2V)$

RFIN Power $\dots \dots \dots 16dBm$

$I_{COMP}, I_{VOUT} \dots \dots \dots \pm 10mA$

$V_{OUTADJ}, V_{REF}, V_{COMP}, V_{OUT}, G_0, G_1, LEN \dots -0.3V$ to V_{CC}

Operating Temperature Range (Note 2) $\dots -40^\circ C$ to $85^\circ C$

Max Junction Temperature $\dots \dots \dots 125^\circ C$

Storage Temperature Range $\dots \dots \dots -65^\circ C$ to $150^\circ C$

PIN CONFIGURATION

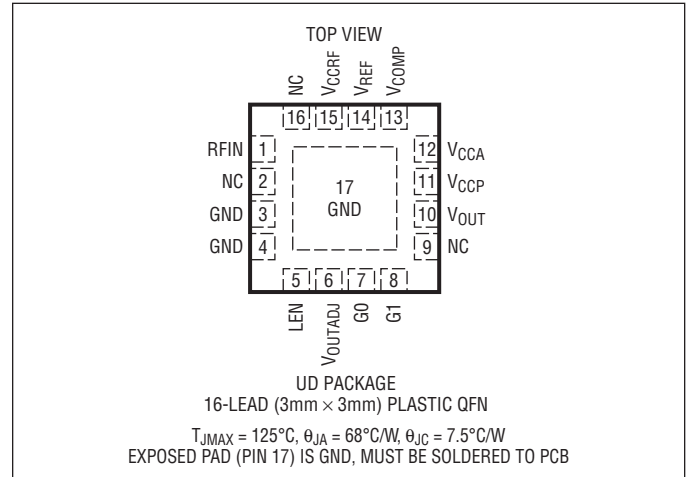

ORDER INFORMATION

LEAD FREE FINISH	TAPE AND REEL	PART MARKING	PACKAGE DESCRIPTION	TEMPERATURE RANGE
LTC5564IUD#PBF	LTC5564IUD#TRPBF	LFRF	16-Lead (3mm x 3mm) Plastic QFN	-40°C to 85°C

Consult LTC Marketing for parts specified with wider operating temperature ranges.

Consult LTC Marketing for information on non-standard lead based finish parts.

For more information on lead free part marking, go to: <http://www.linear.com/leadfree/>

For more information on tape and reel specifications, go to: <http://www.linear.com/tapeandreeel/>

ELECTRICAL CHARACTERISTICS The ● denotes the specifications which apply over the full operating temperature range, otherwise specifications are at $T_A = 25^\circ C$. Supply voltage = $V_{CCRF} = V_{CCA} = V_{CCP} = 5V$, GAIN1, $C_{LOAD} = 10pF$, no RF input signal, unless otherwise noted.

PARAMETER	CONDITIONS	MIN	TYP	MAX	UNITS	
Supply Voltage	●	3.0		5.5	V	
Supply Current			44		mA	
Amplifier Characteristics						
V_{OUT} Output Offset	Supply Voltage = 5V, No RFIN					
	GAIN1	●	195	290	395	mV
	GAIN2	●	195	295	395	mV
	GAIN4			315		mV
	GAIN8			360		mV
	Supply Voltage = 3.3V, No RFIN					
	GAIN1	●	185	280	385	mV
	GAIN2	●	185	280	385	mV
GAIN4			290		mV	
GAIN8			315		mV	

ELECTRICAL CHARACTERISTICS The ● denotes the specifications which apply over the full operating temperature range, otherwise specifications are at $T_A = 25^\circ\text{C}$. Supply voltage = $V_{CCRF} = V_{CCA} = V_{CCP} = 5\text{V}$, GAIN1 , $C_{\text{LOAD}} = 10\text{pF}$, no RF input signal, unless otherwise noted.

PARAMETER	CONDITIONS	MIN	TYP	MAX	UNITS
V_{OUT} Slew Rate Rise/Fall	Supply Voltage = 5V, V_{OUT} 10% to 90%, $\Delta V_{\text{OUT}} = 1.1\text{V}$ (Note 3) GAIN1, Pin = 10dBm to 16dBm GAIN2, Pin = 4dBm GAIN4, Pin = -2dBm GAIN8, Pin = -8dBm		350/70 185/70 120/70 50/50		V/ μs V/ μs V/ μs V/ μs
	Supply Voltage = 3.3V, V_{OUT} 10% to 90%, $\Delta V_{\text{OUT}} = 1.1\text{V}$ (Note 3) GAIN1, Pin = 10dBm to 16dBm GAIN2, Pin = 4dBm GAIN4, Pin = -2dBm GAIN8, Pin = -8dBm		325/70 185/70 120/70 50/50		V/ μs V/ μs V/ μs V/ μs
Demodulation Bandwidth	(Notes 4, 5) GAIN1, $V_{\text{OUT}} = 500\text{mV}$ GAIN2, $V_{\text{OUT}} = 500\text{mV}$ GAIN4, $V_{\text{OUT}} = 500\text{mV}$ GAIN8, $V_{\text{OUT}} = 500\text{mV}$		75 52 35 15		MHz MHz MHz MHz
V_{OUTADJ} Input Range	GAIN1 $\Delta V_{\text{OUT}} = \pm 100\text{mV}$ (Note 5)		0/225		mV
V_{OUT} Load Capacitance	(Note 5)			10	pF
V_{OUT} Output Current	Sourcing, $R_L = 2\text{k}$	1.7			mA
V_{OUT} Response Time	Supply Voltage = 5V, RFIN Step to 50% V_{OUT} (Note 3) GAIN1, Pin = 10dBm to 16dBm GAIN2, Pin = 4dBm GAIN4, Pin = -2dBm GAIN8, Pin = -8dBm		7.0 9.0 11.0 14.0		ns ns ns ns
	Supply Voltage = 3.3V, RFIN Step to 50% V_{OUT} (Note 3) GAIN1, Pin = 10dBm to 16dBm GAIN2, Pin = 4dBm GAIN4, Pin = -2dBm GAIN8, Pin = -8dBm		7.1 9.0 11.0 14.0		ns ns ns ns
V_{OUT} Output Voltage Swing	Supply Voltage = 3V	1.4			V

Comparator Characteristics

Comparator Response Time	10dBm to 16dBm RFIN Step to $V_{\text{COMP}} 50\%$ (Note 3)		9		ns
Comparator Hysteresis			10		mV
I_{VREF} Input Current			-2.3		μA

RF Characteristics

RFIN Frequency Range	(Note 6)		0.6 to 15		GHz
RFIN AC Input Resistance	Frequency = 1000MHz, Power Level = 0dBm		135		Ω
RFIN Input Shunt Capacitance	Frequency = 1000MHz, Power Level = 0dBm		0.77		pF
RFIN Input Power Range	(Note 6)		-24 to 16		dBm

Digital I/O

LEN $V_{\text{IL}}/V_{\text{IH}}$		0.8		$V_{\text{CCA}} - 0.8$	V
G0 $V_{\text{IL}}/V_{\text{IH}}$		0.8		$V_{\text{CCA}} - 0.8$	V
G1 $V_{\text{IL}}/V_{\text{IH}}$		0.8		$V_{\text{CCA}} - 0.8$	V

Note 1: Stresses beyond those listed under Absolute Maximum Ratings may cause permanent damage to the device. Exposure to any Absolute Maximum Rating condition for extended periods may affect device reliability and lifetime.

Note 2: The LTC5564 is guaranteed functional within the operating temperature range from -40°C to 85°C .

Note 3: RFIN step from no power to stated level.

Note 4: See typical curve for bandwidth vs output voltage.

Note 5: See Applications Information section.

Note 6: Specification is guaranteed by design and not 100% tested in production.

TYPICAL PERFORMANCE CHARACTERISTICS

Demodulation Bandwidth

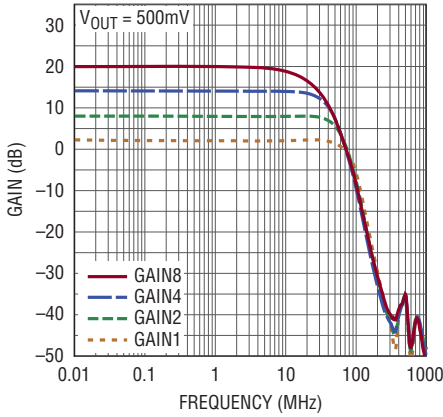

5564 G01

Demodulation Bandwidth vs V_{OUT}

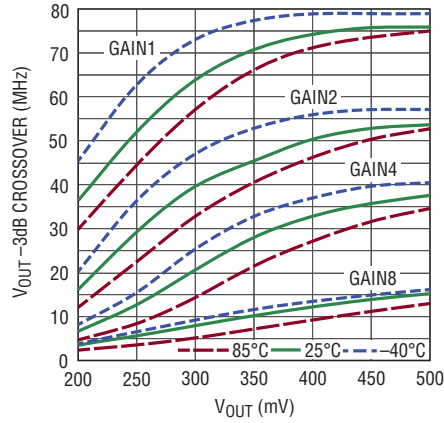

5564 G02

V_{OUT} Pulse Response, $P_{IN} = 8\text{dBm}$

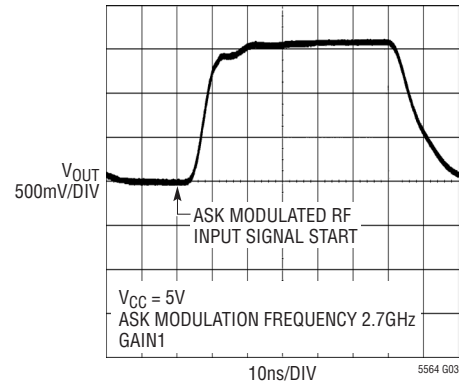

5564 G03

V_{OUT} Pulse Response = -10dBm

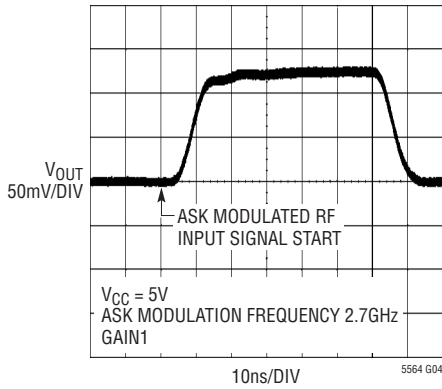

5564 G04

V_{OUT} Offset vs Supply Voltage

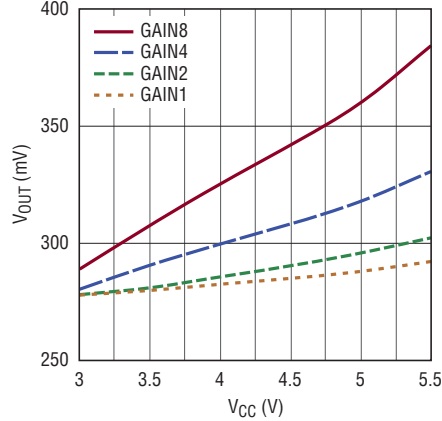

5564 G05

V_{OUT} Offset vs Temperature GAIN1

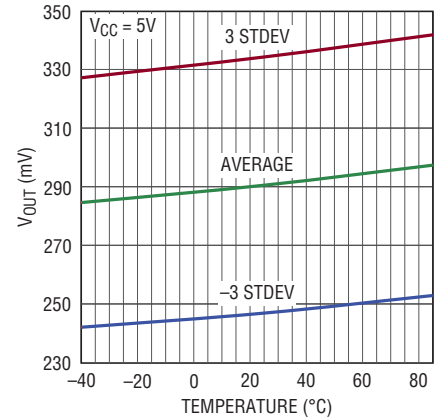

5565 G06

V_{OUT} Offset vs Temperature GAIN2

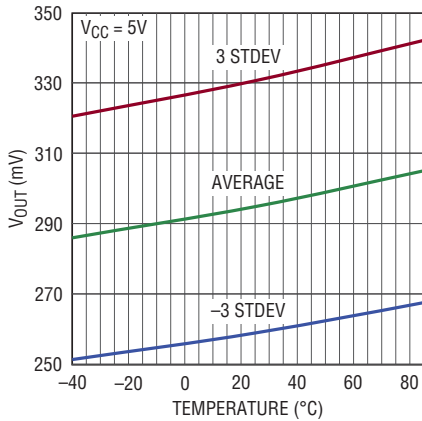

5565 G07

V_{OUT} Offset vs Temperature GAIN4

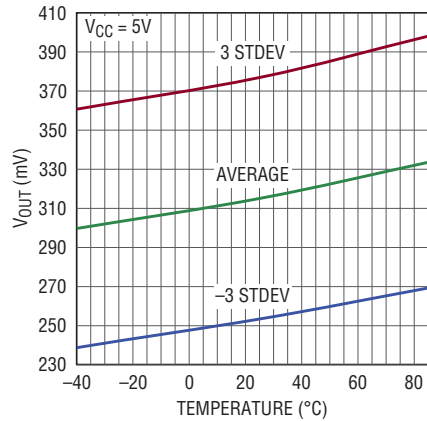

5565 G08

V_{OUT} Offset vs Temperature GAIN8

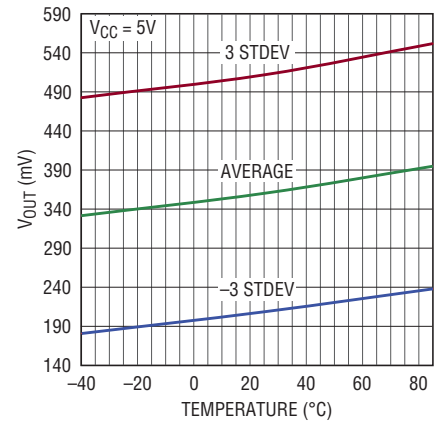

5565 G09

TYPICAL PERFORMANCE CHARACTERISTICS

Supply Current vs Supply Voltage

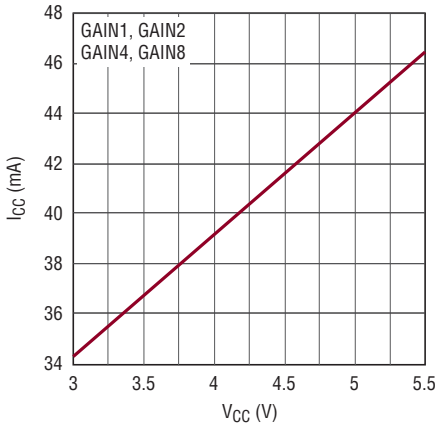

5564 G10

V_{OUT} vs Input Power 700MHz

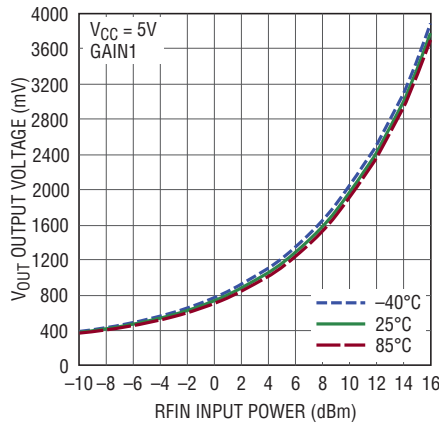

5564 G24

V_{OUT} vs Input Power 1.9GHz

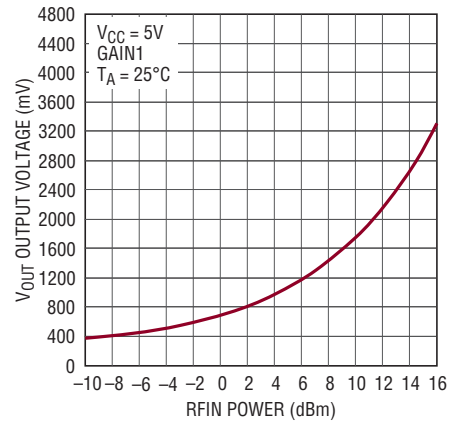

5564 G25

V_{OUT} vs Input Power 2.7GHz

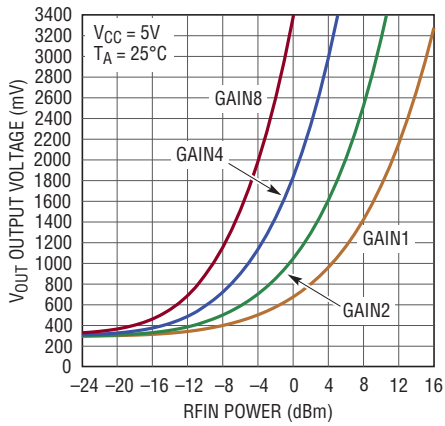

5564 G11

V_{OUT} vs Input Power 2.7GHz

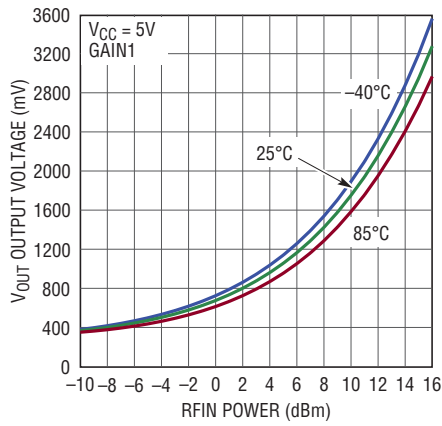

5564 G12

V_{OUT} vs Input Power 5.8GHz

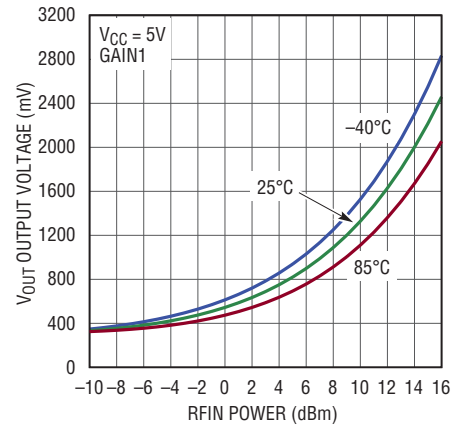

5564 G13

V_{OUT} vs Input Power 8GHz

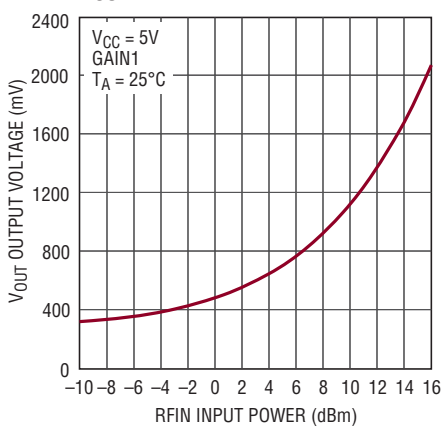

5564 G26

V_{OUT} vs Input Power 10GHz

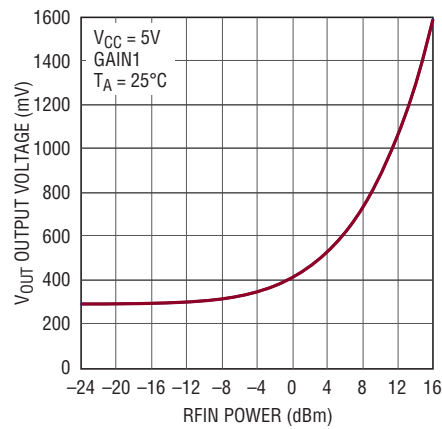

5564 G27

TYPICAL PERFORMANCE CHARACTERISTICS

V_{OUT} vs Input Power 10GHz

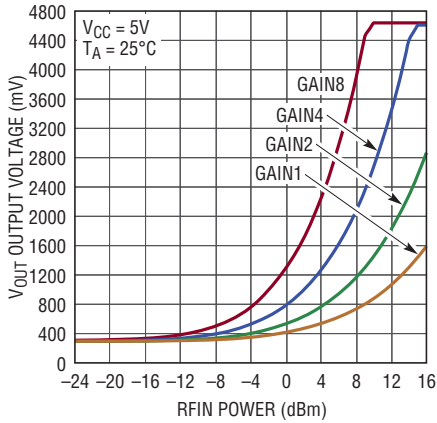

V_{OUT} vs Input Power 12GHz

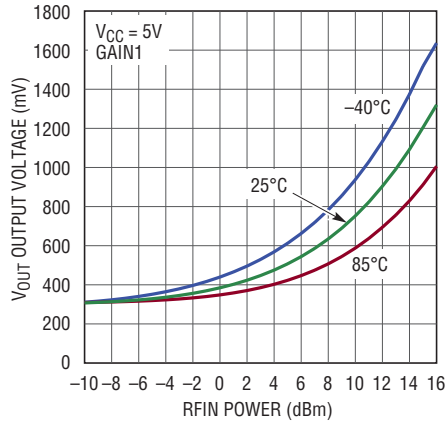

V_{OUT} vs Input Power 15GHz

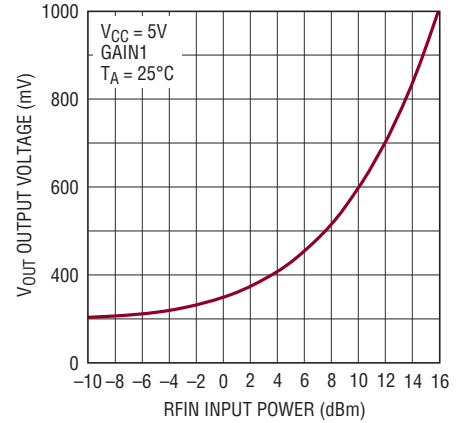

Comparator Threshold Voltage vs RF Input Power

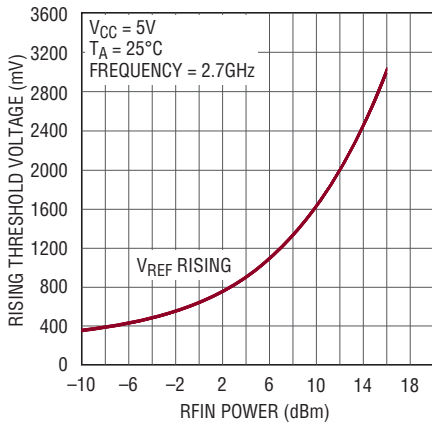

Comparator Rising Edge Threshold vs Frequency

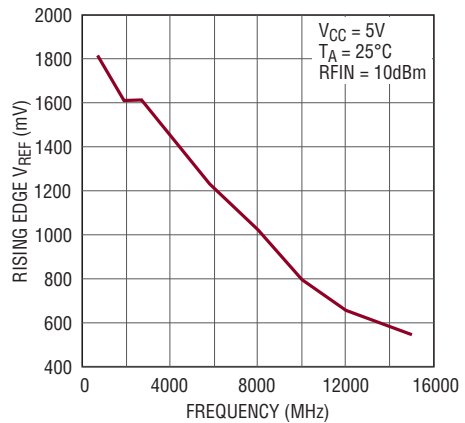

GAIN1 V_{OUT}/RFIN Histogram

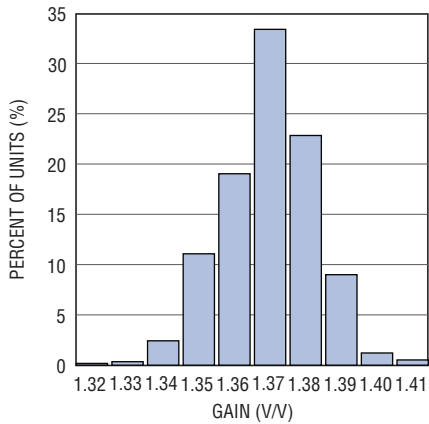

GAIN2 V_{OUT}/RFIN Histogram

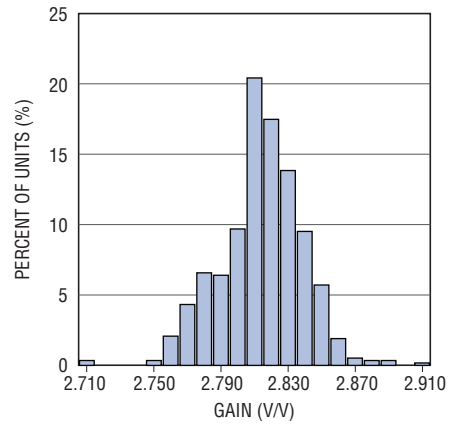

TYPICAL PERFORMANCE CHARACTERISTICS

GAIN4 V_{OUT}/R_{FIN} Histogram

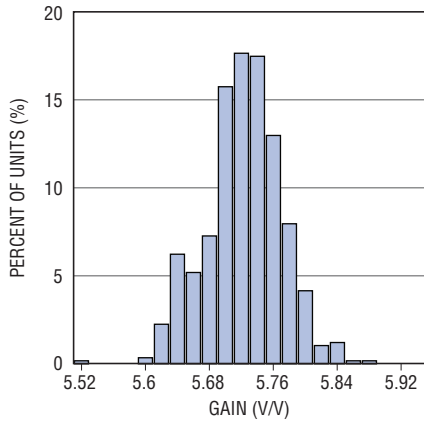

5564 G19

GAIN8 V_{OUT}/R_{FIN} Histogram

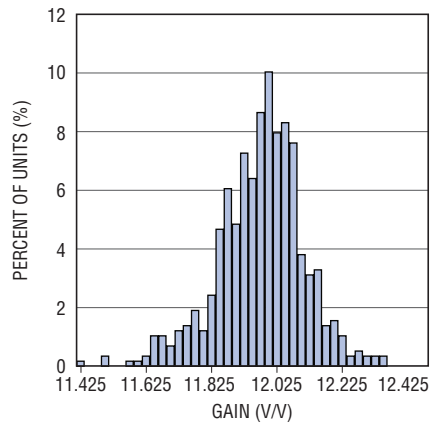

5564 G20

GAIN2/GAIN1 Histogram

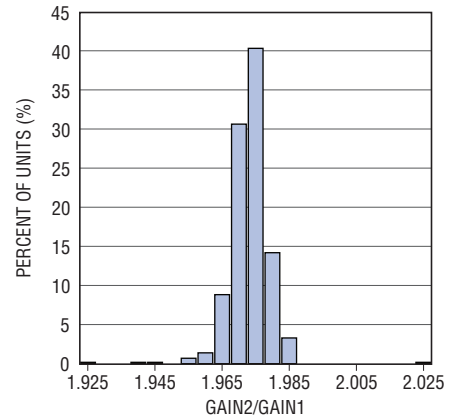

5564 G21

GAIN4/GAIN2 Histogram

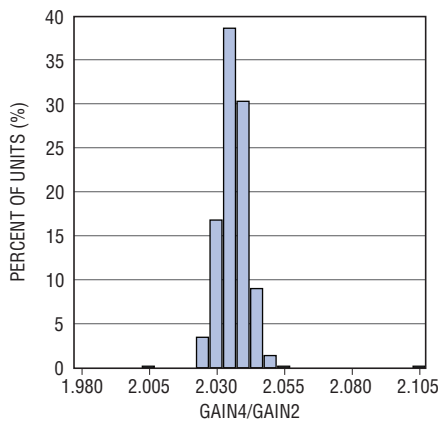

5564 G22

GAIN8/GAIN4 Histogram

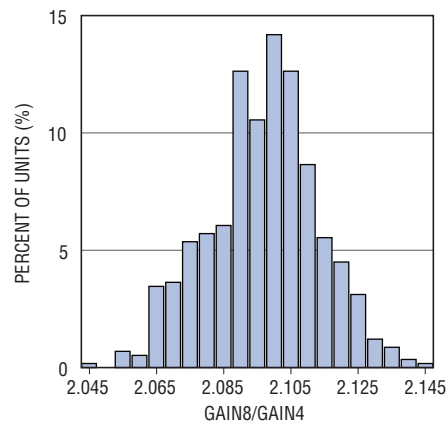

5564 G23

PIN FUNCTIONS

RFIN (Pin 1): RF Input Voltage. A coupling capacitor must be used to connect to the RF signal source. This pin has an internal 250Ω termination, an internal Schottky diode detector and an internal 8pF reservoir capacitor.

NC (Pins 2, 9, 16): No Connect. These pins should be left unconnected by the user for best RF performance.

GND (Pins 3, 4, Exposed Pad Pin 17): These pins should be tied to system ground. See Applications Information for best practices.

LEN (Pin 5): Comparator Latch Enable Input. V_{COMP} will be latched when LEN is high and transparent when LEN is low.

V_{OUTADJ} (Pin 6): Amplifier Output Offset Adjust. When left floating, the V_{OUT} pin of the amplifier will be at its nominal quiescent output offset value. See the Applications Information section for adjustment range.

G0, G1 (Pins 7, 8): Amplifier Gain Selection. Logic low or high levels on the G0 and G1 pins will change the internal amplifier gain, bandwidth and slew rate characteristics. See the Applications Information section for gain setting codes.

V_{OUT} (Pin 10): Detector Amplifier Output.

V_{CCP} (Pin 11): High Current Power Supply Pin.

V_{CCA} (Pin 12): Analog Power Supply Pin.

V_{COMP} (Pin 13): Comparator Output.

V_{REF} (Pin 14): Comparator Negative Input. Apply an external reference voltage to this pin.

V_{CCRF} (Pin 15): RF Power Supply Pin.

SIMPLIFIED BLOCK DIAGRAM

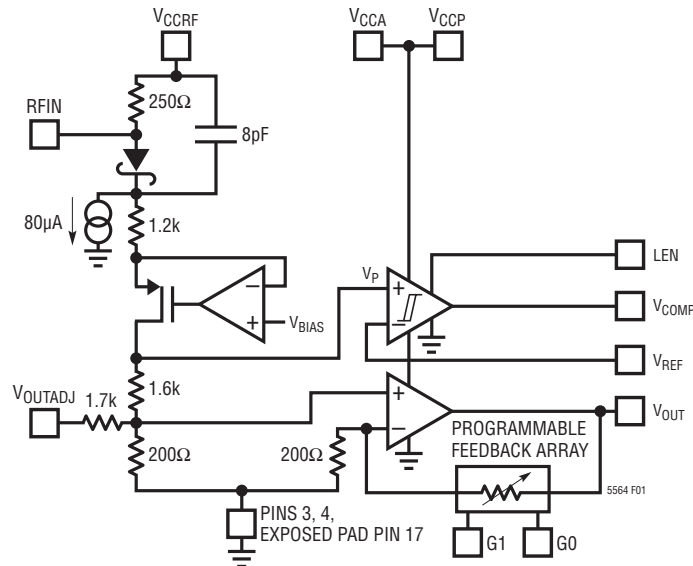

Figure 1. Simplified Block Diagram

APPLICATIONS INFORMATION

Operation

The LTC5564 is a fast RF detector with a high speed amplifier and comparator. This product integrates these functions to provide RF detection over frequencies ranging from 600MHz to 15GHz. These functions include an RF Schottky peak detector, internally compensated operational amplifier, and a comparator as shown in Figure 1. The LTC5564 has selectable amplifier gains, amplifier output offset adjustment and comparator latch enable capabilities.

Amplifier

The high speed amplifier offers four gain settings and is capable of driving a 1.7mA load with an output swing range of approximately 295mV to $V_{CC} - 1.6V$. See Table 1 for gain setting operation.

The V_{OUTADJ} pin provides output DC offset adjustment to satisfy various interface requirements. Setting V_{OUT} to 500mV also provides the maximum demodulation bandwidth in each gain mode. See Electrical and Typical Performance Characteristics curve. See Table 1 for the

typical V_{OUTADJ} voltage for the desired V_{OUT} DC output offset in each gain setting.

RF Detector

The internal temperature compensated Schottky diode peak detector converts the RF input signal to a low frequency signal. The detector demonstrates excellent efficiency and linearity over a wide range of input power levels. The Schottky diode is nominally biased at 180 μ A and drives a parallel reservoir capacitor-resistor network of 8pF and 1.2k.

Comparator

The high speed comparator compares the external reference voltage on the V_{REF} pin to the internal signal voltage V_P from the peak detector and produces the output logic signal V_{COMP} . V_P is the internal comparator positive input as shown in Figure 1.

LEN provides latch enable/disable functionality as shown in Figure 2.

Table 1. Gain Mode and Typical V_{OUTADJ} Operation

PIN		GAIN MODE	DESCRIPTION	REQUIRED V_{OUTADJ} FOR A GIVEN DC OUTPUT OFFSET
G1	G0			
GND	GND	GAIN1	Minimum Gain Setting ($V_{OUT}/RFIN \approx 1.5dB$)	$V_{OUTADJ} = 0.95 \cdot V_{OUT} - 0.174$
GND	V_{CCA}	GAIN2	$V_{OUT}/RFIN$ Increased 6dB	$V_{OUTADJ} = (V_{OUT} - 0.07)/2.10$
V_{CCA}	GND	GAIN4	$V_{OUT}/RFIN$ Increased 12dB	$V_{OUTADJ} = (V_{OUT} + 0.05)/3.16$
V_{CCA}	V_{CCA}	GAIN8	$V_{OUT}/RFIN$ Increased 18dB	$V_{OUTADJ} = (V_{OUT} + 0.25)/5.26$

Note: Valid range for $V_{OUT} \approx 0.195V \leq V_{OUT} \leq V_{CC} - 1.6$

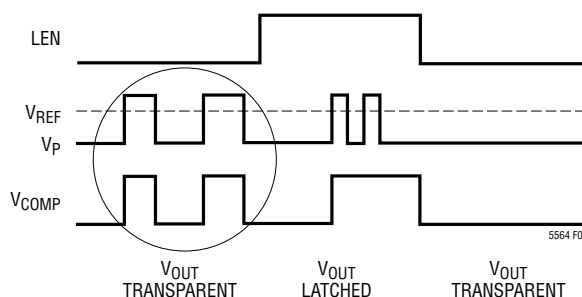

Figure 2. LTC5564 Comparator Latch Enable Function

APPLICATIONS INFORMATION

Propagation Delay, Slew Rate and Response Time

The LTC5564 has been designed for high slew rate operation. For RF input power levels of 10dBm to 16dBm and a GAIN1 setting, the internal amplifier will slew at 350V/ μ s. In a given gain setting slew rate will be maximized for larger input power levels. Slew rate will degrade with smaller RFIN amplitude signals or when the amplifier gain is increased. See Electrical Characteristics.

The LTC5564 has been designed to function as a positive peak detector. Consequently, the device responds to a rising signal at the RF detector input much more rapidly than a falling signal. Correspondingly, the rising edge of V_{OUT} transitions much more rapidly than the falling edge transitions as shown in Figure 3.

When operating in unity gain with a 10dBm to 16dBm RF input signal, the propagation delay to fifty percent ΔV_{OUT} is approximately 7.0ns.

The operational amplifier has been internally compensated to provide 75MHz bandwidth with $V_{OUT} = 500$ mV and a GAIN1 mode setting. With no RF input the output offset will be approximately 290mV. Lowering the output offset will degrade bandwidth performance. See the Typical Performance Characteristics.

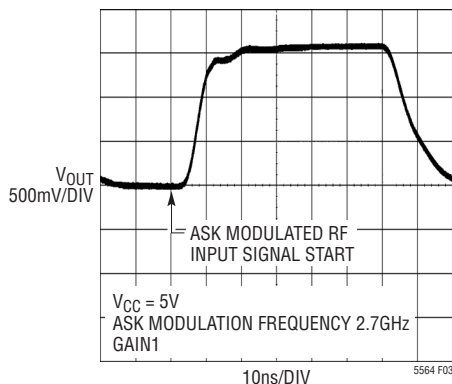

Figure 3. V_{OUT} Pulse Response, $P_{IN} = 8$ dBm

Loading, Bypass Capacitors and Board Layout

The LTC5564 has been designed to directly drive a capacitive load of 10pF at V_{OUT} . When driving a capacitive load greater than 10pF a series resistance should be added between V_{OUT} and the load to maintain good stability. This resistance should be placed as close to V_{OUT} as possible. See Table 2 for typical series resistor values for various capacitive loads.

Table 2. Typical Series Resistor Values for V_{OUT} Capacitive Loading

C_{LOAD}	R SERIES
Up to 10pF	0 Ω
11pF to 20pF	40 Ω
21pF to 100pF	68 Ω
Greater Than 100pF	100 Ω

Good layout practice and proper use of bypass capacitors will improve circuit performance and reduce the possibility of measurement error. Bypass capacitors should be used for pins V_{CCRF} , V_{CCA} , V_{CCP} , V_{OUTADJ} and V_{REF} . Bypass capacitors should be connected as close to the LTC5564 as possible. All ground return path lengths and ohmic losses should be minimized. See Figure 5 in the Applications Information section for the demo board schematic showing these bypass capacitances.

The LTC5564 return path for all supply currents is through the Pin 17 exposed pad. A high resistance path from the Pin 17 exposed pad to power supply ground will cause a V_{OUT} output offset error. Board layout and connections that minimize ohmic losses from the Pin 17 exposed pad to power supply ground will reduce this error. Measurements being made relative to LTC5564 ground should be made as close to the Pin 17 exposed pad to reduce errors.

APPLICATIONS INFORMATION

Applications

The LTC5564 can be used as a self-standing signal strength measurement receiver for a wide range of input signals from -24dBm to 16dBm and frequencies from 600MHz to 15GHz .

In addition to power detection, the LTC5564 may be used as a demodulator for AM and ASK modulated signals. Depending on the application the RSSI may be split into two branches to provide AC-coupled data (e.g., audio) and a DC-coupled RSSI output for signal strength measurement and AGC.

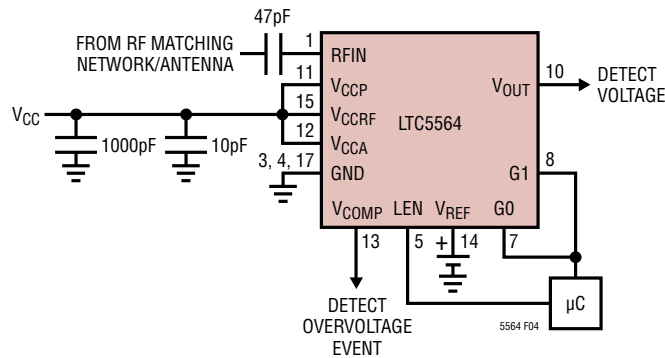

Figure 4. 600MHz to 15GHz Power Detector

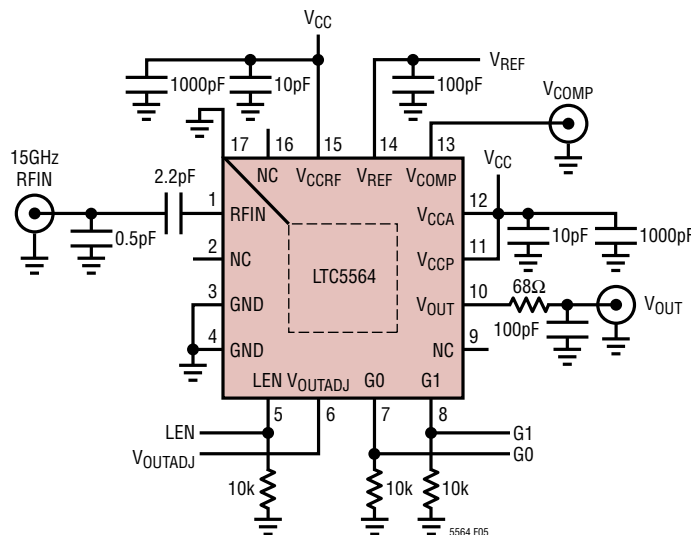
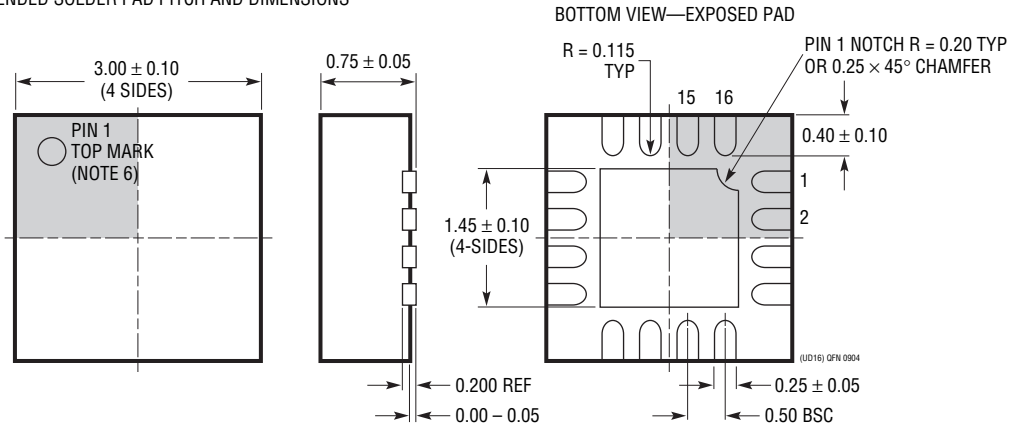
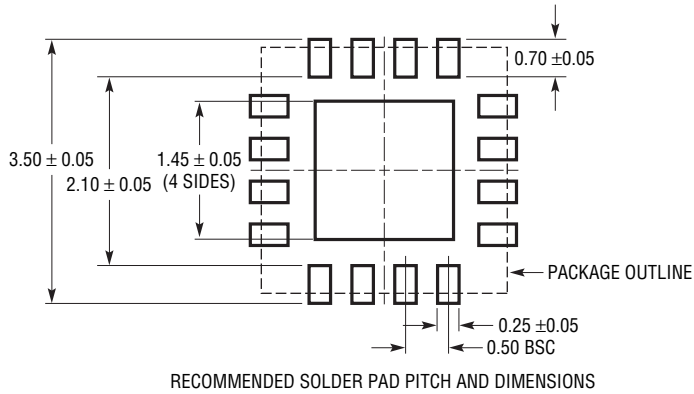

Figure 5. Demo Board Schematic Optimized for 15GHz

PACKAGE DESCRIPTION

UD Package
16-Lead Plastic QFN (3mm × 3mm)
 (Reference LTC DWG # 05-08-1691)



1. DRAWING CONFORMS TO JEDEC PACKAGE OUTLINE MO-220 VARIATION (WEED-2)
2. DRAWING NOT TO SCALE
3. ALL DIMENSIONS ARE IN MILLIMETERS
4. DIMENSIONS OF EXPOSED PAD ON BOTTOM OF PACKAGE DO NOT INCLUDE MOLD FLASH. MOLD FLASH, IF PRESENT, SHALL NOT EXCEED 0.15mm ON ANY SIDE
5. EXPOSED PAD SHALL BE SOLDER PLATED
6. SHADED AREA IS ONLY A REFERENCE FOR PIN 1 LOCATION ON THE TOP AND BOTTOM OF PACKAGE

REVISION HISTORY

REV	DATE	DESCRIPTION	PAGE NUMBER
A	02/11	Replaced and renamed Typical Application drawing	1
		Added new curves to Typical Performance Characteristics	5, 6
		Revised Figure 5	11

TYPICAL APPLICATION

600MHz to 15GHz RF Power Detector

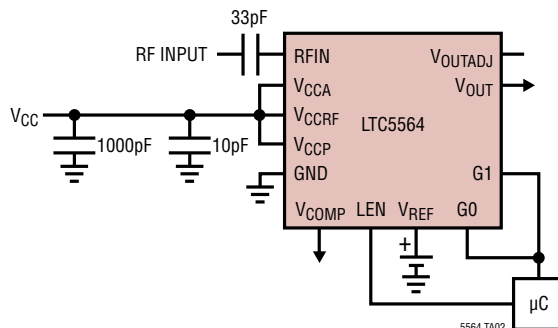

RELATED PARTS

PART NUMBER	DESCRIPTION	COMMENTS
Schottky Peak Detectors		
LTC5505	RF Power Detectors with >40dB Dynamic Range	300MHz to 3GHz, Temperature Compensated, 2.7V to 6V Supply
LTC5507	100kHz to 1000MHz RF Power Detector	100kHz to 1GHz, Temperature Compensated, 2.7V to 6V Supply
LTC5508	300MHz to 7GHz RF Power Detector	44dB Dynamic Range, Temperature Compensated, SC70 Package
LTC5509	300MHz to 3GHz RF Power Detector	36dB Dynamic Range, Low Power Consumption, SC70 Package
LTC5530	300MHz to 7GHz Precision RF Power Detector	Precision V_{OUT} Offset Control, Shutdown, Adjustable Gain
LTC5531	300MHz to 7GHz Precision RF Power Detector	Precision V_{OUT} Offset Control, Shutdown, Adjustable Offset
LTC5532	300MHz to 7GHz Precision RF Power Detector	Precision V_{OUT} Offset Control, Adjustable Gain and Offset
LTC5536	Precision 600MHz to 7GHz RF Power Detector with Fast Comparator Output	25ns Response Time, Comparator Reference Input, Latch Enable Input, -26dBm to +12dBm Input Range
RF Log Detectors		
LT5534	50MHz to 3GHz Log RF Power Detector with 60dB Dynamic Range	± 1 dB Output Variation Over Temperature, 38ns Response Time, Log Linear Response
LT [®] 5537	Wide Dynamic Range Log RF/IF Detector	Low Frequency to 1GHz, 83dB Log Linear Dynamic Range
LT5538	75dB Dynamic Range 3.8GHz Log RF Power Detector	± 0.8 dB Accuracy Over Temperature
RMS Detectors		
LT5570	60dB Dynamic Range RMS Detector	40MHz to 2.7GHz, ± 0.5 dB Accuracy Over Temperature
LTC5581	6GHz RMS Power Detector, 40dB Dynamic Range	± 1 dB Accuracy Over Temperature, Log Linear Response, 1.4mA at 3.3V
LTC5587	10MHz to 6GHz RMS Detector with Digitized Output	40dB Dynamic Detection Range, Integrated 12-Bit Serial Output ADC, ± 1 dB Accuracy Over Temperature
LTC5582	10GHz, 57dB Dynamic Range RMS Detector	40MHz to 10GHz Operation, ± 0.5 dB Linearity Single-Ended RF Output—Requires No External Balun Transformer
LTC5583	6GHz, Matched Dual RMS Detector Measures VSWR	Up to 60dB Dynamic Range, ± 0.5 dB Accuracy Over Temperature, 40dB Channel-to-Channel Isolation with Single-Ended RF Inputs