



Real-time keeping on STM8S and STM8A devices and usage of auto-wakeup unit (AWU) and beeper

Introduction

The purpose of this application note is to explain how to keep real-time information on a STM8S or STM8A device maintained in low power mode.

Only simple solutions which do not require any additional hardware are described in this application note. They are suitable for applications which do not need a very accurate real-time measurement.

To benefit fully from the information in this application note, the user should be familiar with the STM8S and STM8A microcontroller architecture and with the basics of C language.

For further information on the STM8S and STM8A family features, pinout and electrical characteristics, please refer to the STM8S and STM8A datasheets.

An STM8S and STM8A firmware package is delivered with this application note. It contains the complete C source code of an example described in this application note, so that the user can compile, link or modify it as necessary.

This document and its associated firmware package, are written to accompany the STM8S and STM8A firmware library. It includes many examples describing how to use the STM8S and STM8A timers, the clock system, the beeper and the auto-wakeup unit mentioned in this application note.

Related documents (available for download from www.st.com):

AN2780 associated firmware package

STM8S and STM8A firmware library

AN2822 “STM8S and STM8A high speed internal oscillator calibration”

AN2857 “STM8S and STM8A family power management”

AN2645 “Migration and compatibility guidelines for STM8S and STM8A microcontroller applications”

Contents

- 1 Real-time measurement capability 5**
 - 1.1 Time base common to auto-wakeup unit and beeper 5
 - 1.2 Solution using the auto-wakeup unit in Active-halt mode 6
 - 1.2.1 Introduction 6
 - 1.2.2 Description 6
 - 1.3 Solution using the beeper 9
 - 1.3.1 Introduction 9
 - 1.3.2 Beeper solution implementation 9
 - 1.4 Other solutions 10

- 2 Associated software example description 11**
 - 2.1 Main variables, definitions and constants used by the software 11
 - 2.1.1 Variables defined in main.c file 11
 - 2.1.2 Configuration definitions in rtc.h file 11
 - 2.1.3 Configuration constants defined in STM8S and STM8A firmware library 12
 - 2.2 Initialization procedures 12
 - 2.3 Application interrupt routine 12
 - 2.4 Application interface - real-time conversions 13
 - 2.4.1 First alternative solution: real-time kept continuously 14
 - 2.4.2 Second alternative solution: real-time converted on request 14

- 3 Firmware environment 16**

- 4 Test environment 17**

- 5 Accuracy of the used method 18**
 - 5.1 Conclusion 18

- 6 Revision history 19**

List of tables

Table 1. List of files included in the STM8S and STM8A firmware package 16
Table 2. Revision history 19

List of figures

Figure 1. Time base block diagram for AWU and beeper 5

Figure 2. AWU block diagram 6

Figure 3. AWU operation in applications using only AWU interrupts 7

Figure 4. AWU operation in applications using the AWU interrupt and other
interrupt source 8

Figure 5. Beeper block diagram example 9

Figure 6. BEEP signal edge external interrupt - example of increment & compare
cycle performed on pair of registers of fx_time structure 13

Figure 7. Main loop service checking the one-second events 14

Figure 8. Main loop service checking the real-time update request 15

1 Real-time measurement capability

1.1 Time base common to auto-wakeup unit and beeper

This application note focuses on solutions using one of the following STM8S and STM8A peripherals: auto-wakeup unit or beeper. These peripherals share a common 128 kHz clock (LS clock) which can be driven either by a low speed internal RC oscillator (LSI) or by a high speed external crystal/ceramic resonator (HSE), depending on the CLKAWUSEL option bit (see Figure below).

Figure 1. Time base block diagram for AWU and beeper

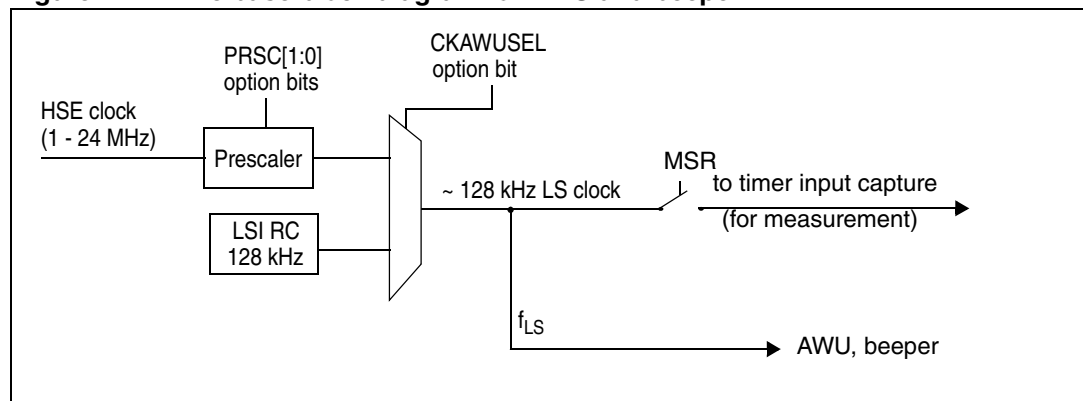

The HSE and LSI clock sources have different characteristics:

- The HSE source has the advantage of performing more accurate measurements but the power consumption is higher (increased by about 0.5 mA) as the system must keep the HSE clock running while it stays in low power mode. The HSE clock can be divided by setting the PRSC option bits to get a LS clock frequency close to 128 kHz or a lower frequency.
- The LSI clock system guarantees a much lower power consumption (consumption of about 5 μ A) but it has the disadvantage of being less accurate and highly temperature-dependent (about $\pm 12.5\%$ within the whole temperature range).
The time interval measurement accuracy can be improved by measuring the LSI frequency internally. This can be performed by connecting the LSI clock to a given timer input capture through the switch controlled by the MSR bit in the AWU_CSR register and by setting properly the timer system for input capture capability. TIM3 is the dedicated timer for this LSI measurement in most STM8S and STM8A devices. TIM1 is used if TIM3 is not present. Some examples of input capture setting can be found in the STM8S and STM8A firmware library.

Note: *If the LSI clock frequency is measured while the microcontroller is driven by the HSI clock (internal high speed oscillator), it is possible to achieve a greater accuracy by calibrating the HSI clock before measuring the LSI frequency. The user can find further information on HSI calibration in the AN2822 application note (STM8S and STM8A high speed internal oscillator calibration).*

1.2 Solution using the auto-wakeup unit in Active-halt mode

1.2.1 Introduction

The basic software principle is to keep track of the number of elapsed time intervals detected by the AWU. The accumulated time can easily be converted from this data by loading a structure keeping real-time information either on request or at regular intervals.

1.2.2 Description

The auto-wakeup unit (AWU) provides an internal wakeup time base that is used when the MCU goes into Active-halt mode. The measurement of this wakeup time can be used to keep real-time information but some limitations must be considered, as described in the following sections.

Figure 2. AWU block diagram

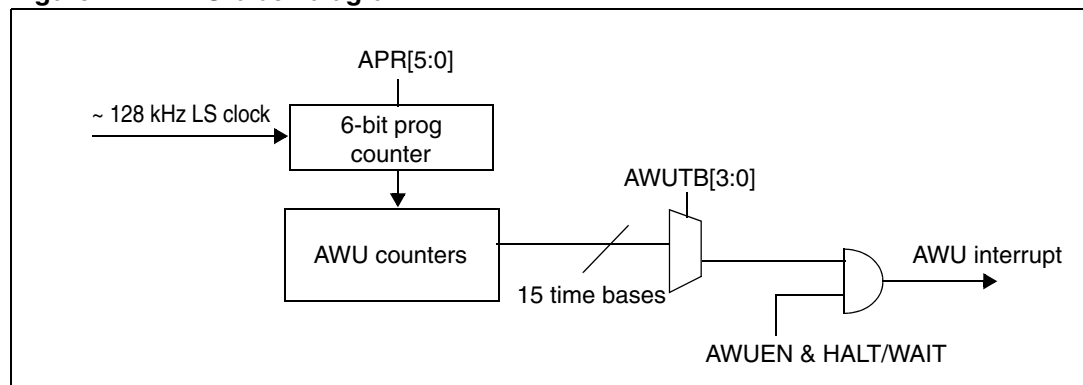

The AWU time intervals depend on the prescaler value defined in the APR bits of the AWU_APR register and on the AWUTB bits programmed in the AWU_TBR register. To enter Active-halt mode, the auto-wakeup unit must be enabled by setting the AWUEN bit in the AWU_CSR register before HALT instruction execution.

The AWU counters are running and counting only when the device is in Active-halt mode. They are stopped when the CPU is in Run mode and initialized again when the microcontroller enters Active-halt mode. This means that the total period is the sum of the AWU interval (AWU timeout) and the duration of the AWU interrupt routine.

Note: As the AL bit in the CFG_GCR register cannot be used in low power mode, when the device goes back from an interrupt, the user must handle by software the device return to Halt mode.

Several cases can be considered (refer to the following sections):

The AWU interrupt is the only interrupt used by the application

1. Constant AWU interrupt service times:

When wakeup events rise at almost equidistant periods, real-time data can be computed as a simple sum of the AWU periods. Two time measurement methods are possible in this case:

- a) The interrupt service time can be disregarded if it is negligible compared to the AWU interval.

Time = sum of AWU intervals

- b) A small constant correction can be applied to the AWU interval to compensate for the time spent in AWU interrupt service.

Time = sum of corrected AWU intervals

2. Irregular AWU interrupt service times (refer to [Figure 3](#))

Two time measurement methods are also possible in this case:

- a) When most AWU services have the same duration, coincidental interrupt services with significantly different durations can be corrected by changing the duration of the next AWU interval in order to keep equidistant periods. This is done by modifying the APR bits in the AWU_APR register and the AWUTB bits in the AWU_TBR register for the next AWU interval. Time can then be computed like in case 1.

- b) When AWU services always have different durations, the time the microcontroller spends in Run mode must be measured, registered and summarized. The real-time data can be computed as a sum of all AWU wakeup intervals plus this summarized Run time.

Time = sum of AWU intervals + sum of all run time procedures

Figure 3. AWU operation in applications using only AWU interrupts

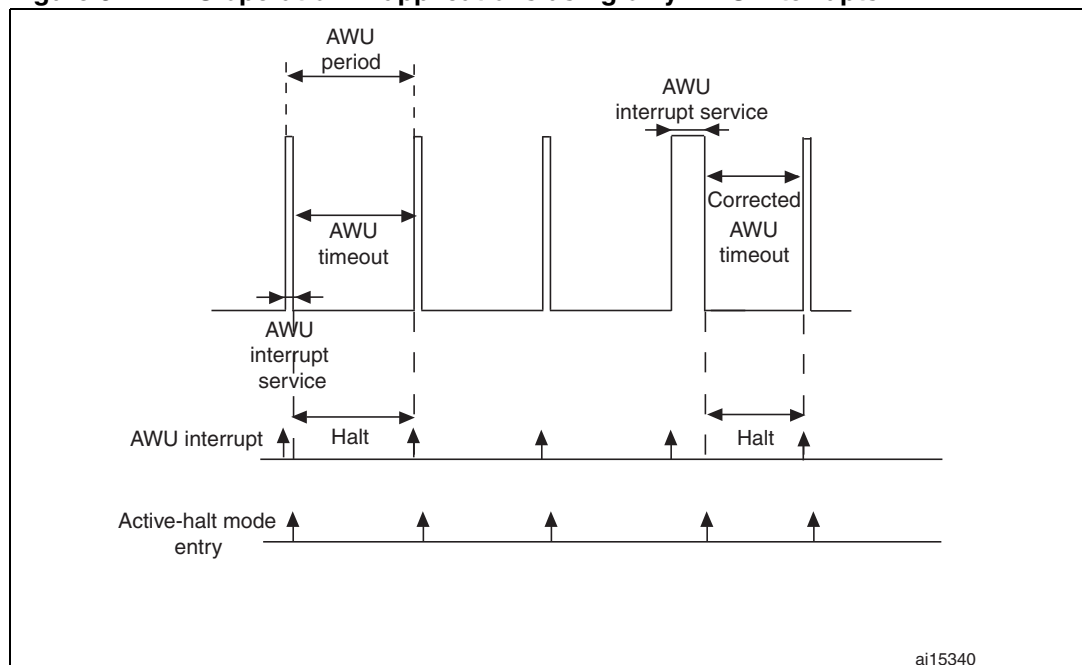

The AWU interrupt service routine is not the only interrupt service and the system has to service other interrupt sources

Refer to *Figure 4*.

This is the most common situation for many applications. As the content of the AWU counters can never be read, time intervals cannot continue being measured when the microcontroller has been woken up by a source other than the AWU interrupt source. Then, there is always an unidentifiable interval between the last entry into Active-halt mode and the rise of the other interrupt. The time continuity of AWU interrupts is then lost. This is the main limitation when using AWU for real-time measurement purposes because most applications need to control several interrupt sources. This limitation restricts the use of the AWU for real-time measurement in applications where the frequency of interrupts from other sources is negligible compared to the frequency of AWU wakeup interrupts.

Figure 4. AWU operation in applications using the AWU interrupt and other interrupt source

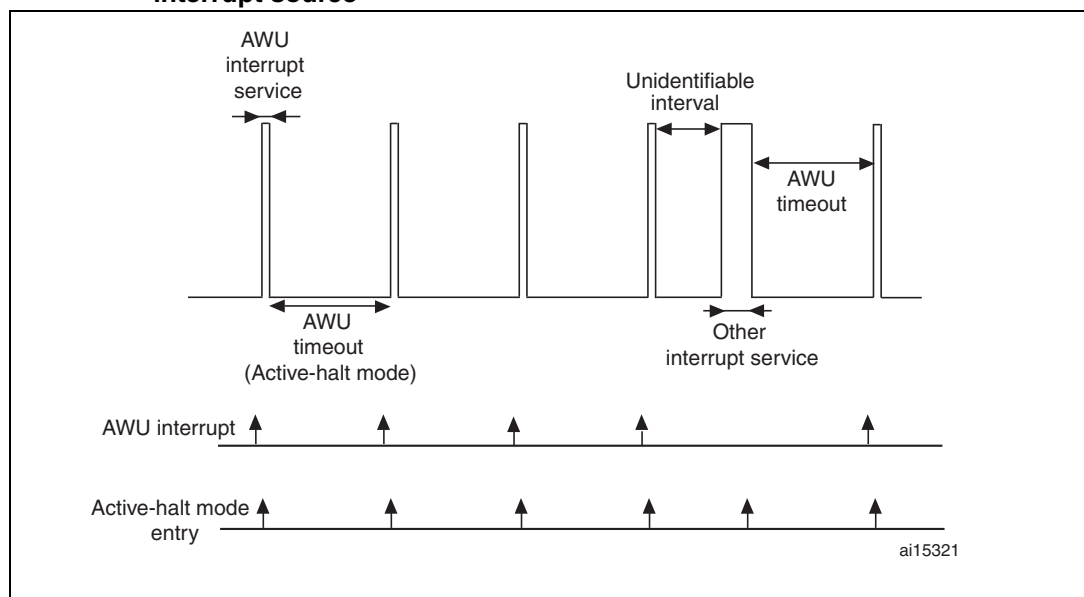

1.3 Solution using the beeper

1.3.1 Introduction

This section provides a procedure using the BEEP signal for measuring real-time in systems entering low power modes. The basic software principle is very similar to the procedure using the AWU. This method uses the output of a low beeper frequency feeding an external interrupt enabled on the same I/O pin.

The application can easily derive a time base from the beeper frequency, because the beeper, when activated, is always running regardless of the mode in which the system stays (low power or run mode).

1.3.2 Beeper solution implementation

The 128 kHz LS clock divided by the beeper divider system is used as a low speed clock source running permanently. This clock signal acts then as an external interrupt to wake up the microcontroller from a low power mode. The BEEP output signal and external interrupt capability can be enabled simultaneously on the BEEP pin (the PD4 pin in STM8S and STM8A devices) so that no external connection or additional GPIO pin generating external interrupts is required.

- To enable the BEEP frequency output:
 - The proper option byte must be programmed in devices where the BEEP pin is an optional alternate function.
 - The BEEPEN bit in the BEEP_CSR register must be set.
- To enable the interrupt input capability:
 - The BEEP pin must be configured as an input with interrupt.
 - The external interrupt sensitivity for the BEEP pin port must be set as either “rising edge only” or “falling edge only”.
 - The appropriate interrupt service routine must be called from the corresponding location in the interrupt vector table.

For low-power systems, it is important to minimize the time spent in run mode and, consequently, to maximize the time interval between two consecutive beeper interrupts. Clearing the BEEPSEL[1:0] bits in the BEEP_CSR register while the BEEPDIV bits are set to 0x1E gives the lowest possible BEEP output frequency (about 500 Hz for 128 kHz LSI - LS clock input is first divided by 32 and then by 8), as shown in [Figure 5](#).

Figure 5. Beeper block diagram example

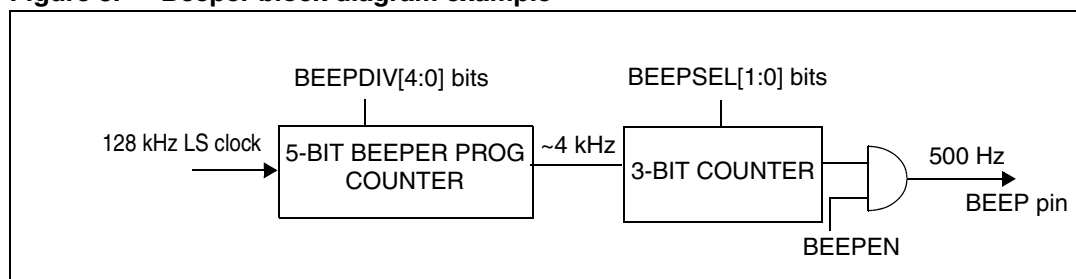

As explained in [Section 1.1](#), the lower accuracy of the LSI source can be compensated by measuring internally its frequency. When the LS clock signal is measured internally by the

dedicated timer, the following formula can be used for calculating the BEEP signal frequency in case the beeper dividers are selected to provide the lowest output frequency:

$$f_{\text{BEEP}} = f_{\text{LS}} / (32 \cdot 8) = (f_{\text{CNT}} / n) / (32 \cdot 8)$$

where

f_{BEEP} = BEEP signal frequency [Hz].

f_{CNT} = timer counter input frequency [Hz].

n = number of timer counter counts within LS signal period.

Then the rounded frequency f_{BEEP} in Hertz is equal to the number of external interrupts counted on the BEEP pin to get the one-second period time base.

The LS measurement accuracy can be increased by setting the input capture prescaler of the timer to its maximum value (bits ICxPSC = 11 in the TIMx_CCMR register) while the timer counter is running at a maximum frequency (HSIDIV and CPUDIV bits cleared in the CLK_CKDIVR register and PSC bits cleared in the TIMx_PSCR register), as described in the example given in the associated firmware package. Then the number of timer counter counts matches eight consecutive LS signal periods. The upper formula is simplified in this case as follows:

$$f_{\text{BEEP}} = f_{\text{LS}} / (32 \cdot 8) = (f_{\text{CNT}} \cdot 8 / N) / (32 \cdot 8) = f_{\text{CNT}} / (N \cdot 32)$$

where

N = number of timer counter counts during eight consecutive LS signal periods.

1.4 Other solutions

The solutions given in [Section 1.2](#) and [Section 1.3](#) are suitable for applications where real-time is used only as an approximate indication (to track the usage or running time of some devices, or to record error occurrences for instance). They should not be used for applications requiring precise real-time measurement.

To keep real-time information more accurately or with consistent measurement in the whole operating temperature range, another solution should be chosen using an external low speed crystal oscillator. The user can select a member of the STM8L subfamily where a real-time clock with low speed external clock source connectivity is included. A wide range of external components keeping real-time autonomously can also be found. They can easily be connected to the STM8S or STM8A in most cases via peripherals like I2C (e.g. M41ST85) or SPI (e.g. M41ST95).

2 Associated software example description

This section describes a software method using the Beeper function as described in [Chapter 1.3](#). The solution is based on STM8S and STM8A firmware library routines. The sections below describe the structure of the software example and how it works:

- Variables are listed in [Section 2.1](#).
- The initialization process is described in [Section 2.2](#).
- The interrupt system registering beeper pulses is described in [Section 2.3](#).
- Two alternative examples of how the real-time can be converted from registered pulses are listed in [Section 2.4.1](#) and [Section 2.4.2](#). The first one keeps real-time information continuously and the second one calculates it on request only.

The application does not require any external connection. The only hardware limitation consists in reserving the external connectivity of the BEEP pin for beeper signal output and external interrupt input purposes.

2.1 Main variables, definitions and constants used by the software

2.1.1 Variables defined in main.c file

- **lsi_freq** ... variable keeping the result of internal measurement of LS clock frequency [Hz],
- **beep_freq** ... variable keeping result of internal computation of beeper output frequency used as a one second interval compare limit [Hz],
- **edge_day_overflow_limit** ... variable keeping computed number of external events within one day period used as a one day interval compare limit,
- **fx_time** ... structure filled with the interrupt service registering number of external events together with the number of overflows of predefined one-second and one-day limits (*edge_second_counter* & *second_overflow_counter* are used for “second” intervals, *edge_day_counter* & *day_overflow_counter* for “day” intervals),
- **real_time** ... structure keeping converted real-time information (seconds, minutes, hours and days). The update of this structure is performed in main loop and is based on the content of the registers in the **fx_time** structure.

2.1.2 Configuration definitions in rtc.h file

- KEEP_RT ... SW software selection between two alternative solutions.
 - If the KEEP_RT constant is defined: real-time information is kept continuously (updated in one-second intervals) in **real_time** structure
 - If KEEP_RT constant is not defined: it is converted into the structure on request only (in this case, the request is simulated by key press event)
- MEASURE_ON_HSE ... SW software selection between two alternative solutions.
 - If the MEASURE_ON_HSE constant is defined: LSI is measured using the HSE frequency.
 - If the MEASURE_ON_HSE constant is not defined, the HSI frequency is used.

2.1.3 Configuration constants defined in STM8S and STM8A firmware library

HSI_VALUE & HSE_VALUE ... constants to determine values of HSI and HSE frequencies.

Note: The accuracy of the LSI value measurement is highly dependent on the difference between the real value of the HSI or HSE clock frequency and the **HSI_VALUE** or **HSE_VALUE** constant entered as a parameter for calculation (see [Section 5: Accuracy of the used method](#)).

2.2 Initialization procedures

Just after the start of the program, software performs LS clock frequency measurement and stores the result into the **lsi_fqcy** variable.

The computed LSI frequency is used as a base for calculating internal compare limits stored into the **beep_fqcy** and **edge_day_overflow_limit** variables. These limits are compared with internal counters counting the number of external interrupts from the BEEP pin signal edges.

- The first limit can be used for measuring a one-second interval (in case real time is continuously updated) and it is equal to the beeper signal frequency in Hz.
- The second one is always used for measuring a one-day interval.

2.3 Application interrupt routine

The main task of the software is to count and register the number of interrupts generated by each falling edge of the BEEP pin signal. The interrupt service routine performs a very short increment & compare cycle on the pair of variables included in the **fx_time** structure registering elapsed one-day intervals (the next cycle is performed by registering one-second intervals when real-time is kept continuously). Refer to the following simplified flowchart.

Figure 6. BEEP signal edge external interrupt - example of increment & compare cycle performed on pair of registers of *fx_time* structure

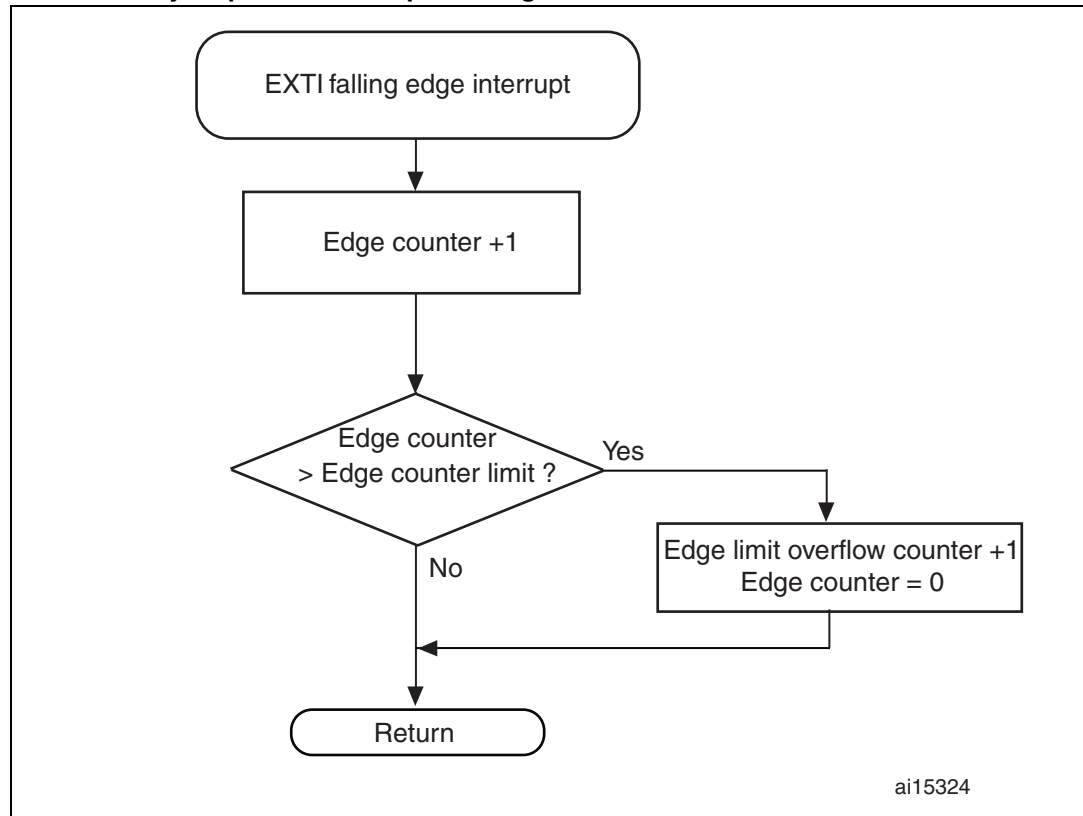

This cycle first increments a counter. Then the counter value is compared with the predefined limit and number of the limit overflows is stored into the next variable. It mainly acts as a prescaler. The number of overflows is used by the main program to define the number of time interval cycles elapsed when real-time information is processed and *real_time* structure content is updated.

2.4 Application interface - real-time conversions

The two alternative methods of recalculation mentioned above are described in more details in this section. Both methods use the information stored in the *fx_time* structure and convert this time information into the *real_time* structure. The only difference is how often and in which way real-time information is recalculated by main loop and how many increment & compare cycles are performed by interrupt service. The main loop always checks the state of overflow registers in the *fx_time* structure either continuously or on application request and converts this information into the *real_time* structure. The result of every conversion reflects the number of detected elapsed intervals and it is stored in the *real_time* structure registers keeping seconds, minutes, hours and etc.

These methods are given as examples only. The user can modify the *fx_time* and/or *real_time* structures. Some other recalculation methods can also be used.

One of these two methods is always selected through the definition control of the KEEP_RT parameter as it is described in [Section 2.1.2: Configuration definitions in rtc.h file](#).

2.4.1 First alternative solution: real-time kept continuously

Keeping real-time information continuously is suitable in case the information is permanently used by the application (e.g. actual time must be displayed or sent). In this case, an additional increment & compare cycle is added for one-second interval measurements into the interrupt service. The elapsed one-second intervals are then checked in the main loop. Real-time incremental routine *rt_increment()* is called from the main loop to process every new elapsed one-second interval detected by interrupt routine. It ensures the actual real-time information is kept continuously in the *real_time* data structure.

Note: As a one-second increment & compare cycle is short and the beeper frequency may not exactly match the one-second interval, a measurement error for this interval can be relatively high (up to 0.1% when the beeper frequency is 500 Hz). The one-second time interval is rounded to the closest integer number of beeper signal pulses. Due to this short measurement interval, a significant error is cumulated when a longer real-time interval is evaluated from this measurement.

Figure 7. Main loop service checking the one-second events

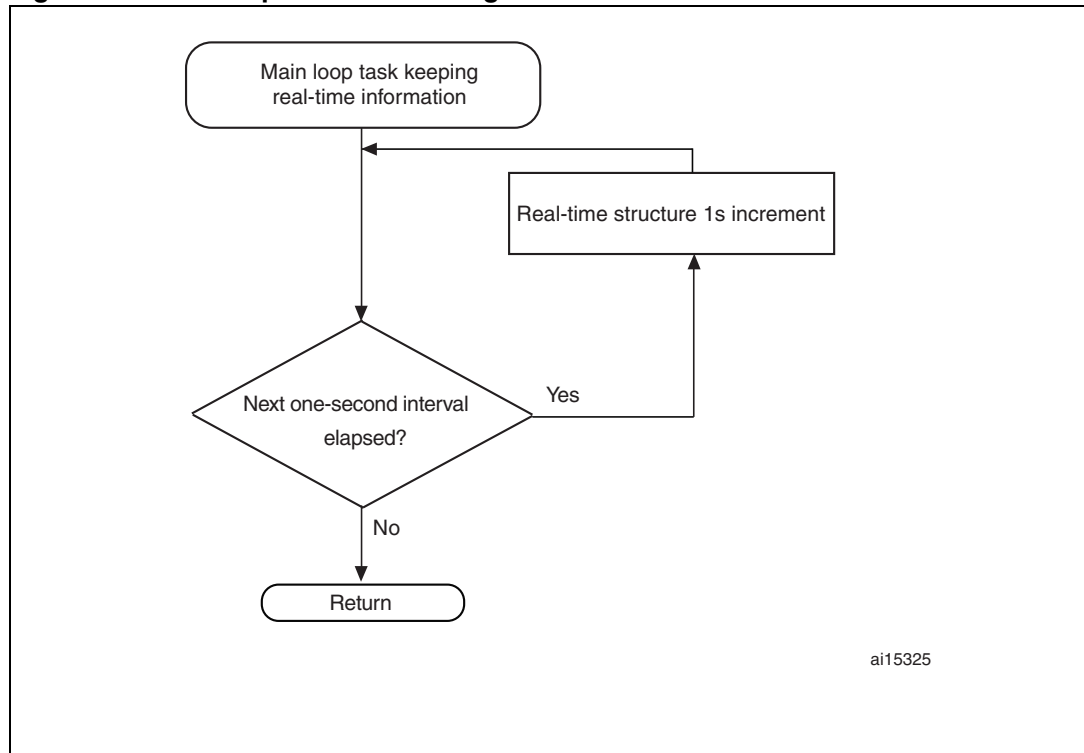

A more accurate “real_time” data structure update calculation can also be performed in this mode at any time, as described in the following section.

2.4.2 Second alternative solution: real-time converted on request

Converting real-time information on request is suitable for low-power systems where the information is needed occasionally (e.g. when errors occur or in specific cases) and when saving power is a priority. Then the interrupt service duration is reduced to a minimum and the recalculation routine from the main loop is called only in case the information is requested. The main loop service then calls the *rt_update()* conversion function only on update request from application. This function updates the content of the user *real_time*

data structure to the current state depending on the content of the internal counters in the **fx_time** structure.

Note: **Drawback:** the conversion is much more complicated in this case, because a few divisions must be performed to obtain values of the seconds, minutes and hours from the current *edge_day_counter* counter content.

Advantage: the measured interval is much longer, so the calculation is more precise when this method is used.

Figure 8. Main loop service checking the real-time update request

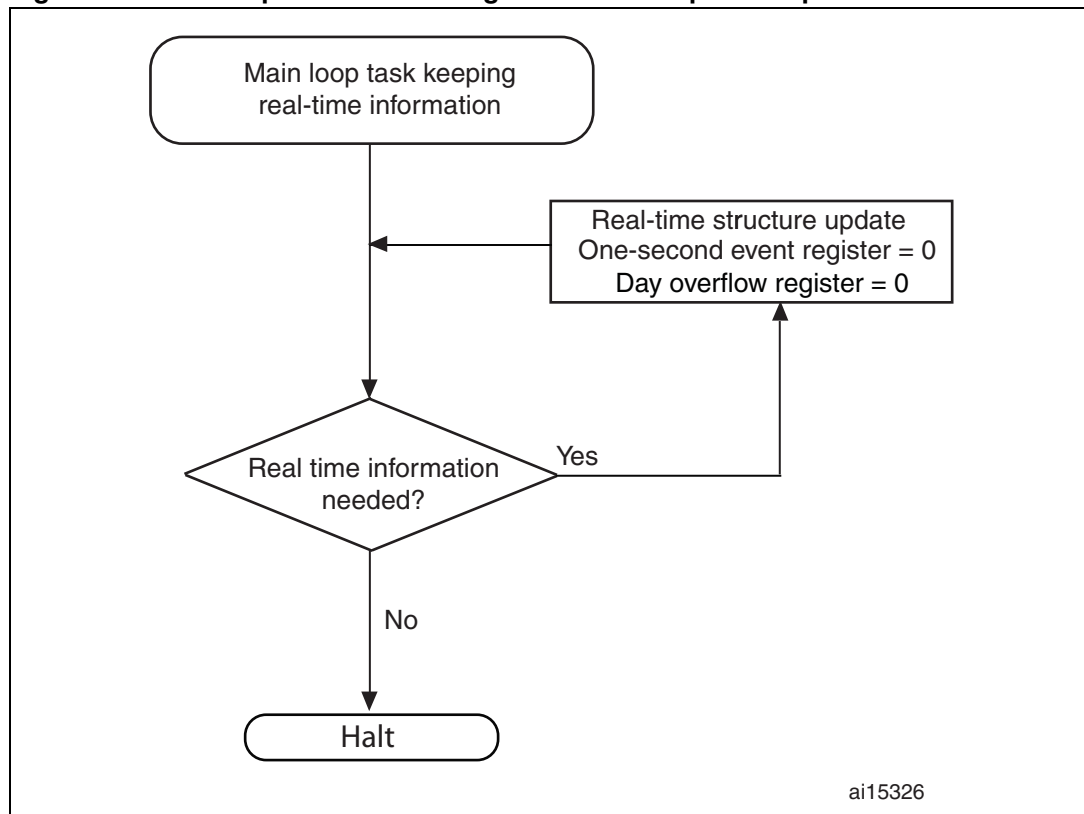

3 Firmware environment

A complete project is included in the STM8S and STM8A firmware package. This project is designed for the ST Visual Develop (STVD) development environment.

Two projects are contained in the associated software package: one for Cosmic compiler and one for the Raisonance compiler. Both projects have been tested using the STM8/128-EVAL evaluation board. To run the proper project example, you must have installed STVD (at least version 3.5.0) and the Cosmic or Raisonance C compiler for STM8 family. All tools are free for download from STMicroelectronics, Cosmic and Raisonance web sites.

Table 1 gives the list of the files included in the package.

Table 1. List of files included in the STM8S and STM8A firmware package

File name	File contents
main.c	RTC routines & example of how to handle them
stm8s_it.c	User interrupt services
stm8s_interrupt_vector.c	STM8S interrupt vector table
stm8s_awu.c	Peripheral file
stm8s_beep.c	Peripheral file
stm8s_clk.c	Peripheral file
stm8s_exti.c	Peripheral file
stm8s_gpio.c	Peripheral file
stm8s_tim3.c	Peripheral file
rtc.h	User header file
stm8s_awu.h	Peripheral header file
stm8s_beep.h	Peripheral header file
stm8s_clk.h	Peripheral header file
stm8s_exti.h	Peripheral header file
stm8s_gpio.h	Peripheral header file
stm8s_tim3.h	Peripheral header file
stm8s_config.h	STM8 hardware configuration header
stm8s_map.h	STM8 hardware mapping header
stm8s_type.h	Common data type header
stm8s_it.h	Interrupt declaration header
stm8s_lib.h	Library peripheral headers including control
mods0.h	Memory model control header

4 Test environment

The functionality of the interface has been tested on STM8/128-EVAL evaluation board. The main.c file of the included project contains simple examples of how to keep real-time information.

- In case real-time data is kept continuously (**KEEP_RT** is defined), the one-second events are checked in main loop and real-time registers are updated in intervals of one second.
- In case real-time data is not kept continuously, real-time registers are updated only on external interrupt service request. This simulation is performed by pressing the “Key” button on the evaluation board. The user can check the current content of real-time structure registers by using the STVD “Read on the fly” debug feature.

Both the BEEP output frequency and the LS clock frequency can be monitored by connecting an oscilloscope to the BEEP pin (PD4) and CLK_CCO pin (PE0). The outputs of these signals are enabled in the initialization phase.

5 Accuracy of the used method

As described in this document, the time measurement accuracy of the methods used in these examples is mainly dependent on LSI measurement accuracy. Consequently, the user must also take into account the fact that the LSI clock frequency varies with temperature and voltage.

In case of a low-power application where consumption is a critical point and often no external frequency signal is available, only the method using internal LSI measurement by HSI frequency can be used.

When the HSI clock feeds the internal timers with a maximal rate and its value is precisely known, the LSI value can be determined from the measurement of 8 consecutive periods with an accuracy of 128 KHz / 16 MHz / 8 ~ 0.1% steps. This means the best theoretical accuracy would be almost equal to 4 seconds per hour.

It is in fact difficult to determine precisely the HSI frequency without any external reference frequency. As the HSI_VALUE constant entered as a parameter for calculation can differ from the real HSI frequency, the LSI result accuracy is significantly reduced.

The default 16 MHz value cannot be used because there is a big tolerance for shipped devices in this case (up to +1.3%/-2.5% at 5 V/25 °C, but up to +3%/-4% in a wider range of supply voltage or temperature).

The HSI can be trimmed internally within an interval of +3/-4% of the frequency range to get a value as near as possible to the 16 MHz nominal value.

Note that the frequency change between two trimming steps is 0.5% of the range (even 1% in some STM8S and STM8A devices), so the difference after trimming can remain too significant.

Much better accuracy can be achieved when the HSI frequency (and, consequently, the LSI) can be measured and/or compared using an exact external reference frequency (e.g. by net frequency). These comparative measurements must be performed at adequate intervals to detect any significant temperature and power supply voltage changes so as to compensate for them.

In addition, the LSI clock frequency also depends on temperature and supply voltage. Temperature and voltage conditions can change this value in the similar range as the HSI in the same conditions. That is why real-time measurement accuracy can be partly improved by repeating periodically the LSI measurement to compensate for possible condition changes.

Note: Finding an accurate external frequency source which can precisely state the value of internal frequency sources is especially a problem for low-cost and battery-supplied applications as a crystal oscillator is a rather expensive solution and battery-supplied devices cannot have a stable net frequency that could be used as a reference.

5.1 Conclusion

The level of accuracy of real-time measurement based on LSI is only suitable for applications working in stable conditions where real-time information is used only as an approximate indication. It is strongly recommended to use an external low frequency signal source or special components keeping real-time information with much better accuracy in any other cases.

6 Revision history

Table 2. Revision history

Date	Revision	Description of changes
18-Mar-2010	1	Initial release
31-Aug-2011	2	Updated to refer to STM8S and STM8A.

Please Read Carefully:

Information in this document is provided solely in connection with ST products. STMicroelectronics NV and its subsidiaries ("ST") reserve the right to make changes, corrections, modifications or improvements, to this document, and the products and services described herein at any time, without notice.

All ST products are sold pursuant to ST's terms and conditions of sale.

Purchasers are solely responsible for the choice, selection and use of the ST products and services described herein, and ST assumes no liability whatsoever relating to the choice, selection or use of the ST products and services described herein.

No license, express or implied, by estoppel or otherwise, to any intellectual property rights is granted under this document. If any part of this document refers to any third party products or services it shall not be deemed a license grant by ST for the use of such third party products or services, or any intellectual property contained therein or considered as a warranty covering the use in any manner whatsoever of such third party products or services or any intellectual property contained therein.

UNLESS OTHERWISE SET FORTH IN ST'S TERMS AND CONDITIONS OF SALE ST DISCLAIMS ANY EXPRESS OR IMPLIED WARRANTY WITH RESPECT TO THE USE AND/OR SALE OF ST PRODUCTS INCLUDING WITHOUT LIMITATION IMPLIED WARRANTIES OF MERCHANTABILITY, FITNESS FOR A PARTICULAR PURPOSE (AND THEIR EQUIVALENTS UNDER THE LAWS OF ANY JURISDICTION), OR INFRINGEMENT OF ANY PATENT, COPYRIGHT OR OTHER INTELLECTUAL PROPERTY RIGHT.

UNLESS EXPRESSLY APPROVED IN WRITING BY TWO AUTHORIZED ST REPRESENTATIVES, ST PRODUCTS ARE NOT RECOMMENDED, AUTHORIZED OR WARRANTED FOR USE IN MILITARY, AIR CRAFT, SPACE, LIFE SAVING, OR LIFE SUSTAINING APPLICATIONS, NOR IN PRODUCTS OR SYSTEMS WHERE FAILURE OR MALFUNCTION MAY RESULT IN PERSONAL INJURY, DEATH, OR SEVERE PROPERTY OR ENVIRONMENTAL DAMAGE. ST PRODUCTS WHICH ARE NOT SPECIFIED AS "AUTOMOTIVE GRADE" MAY ONLY BE USED IN AUTOMOTIVE APPLICATIONS AT USER'S OWN RISK.

Resale of ST products with provisions different from the statements and/or technical features set forth in this document shall immediately void any warranty granted by ST for the ST product or service described herein and shall not create or extend in any manner whatsoever, any liability of ST.

ST and the ST logo are trademarks or registered trademarks of ST in various countries.

Information in this document supersedes and replaces all information previously supplied.

The ST logo is a registered trademark of STMicroelectronics. All other names are the property of their respective owners.

© 2011 STMicroelectronics - All rights reserved

STMicroelectronics group of companies

Australia - Belgium - Brazil - Canada - China - Czech Republic - Finland - France - Germany - Hong Kong - India - Israel - Italy - Japan - Malaysia - Malta - Morocco - Philippines - Singapore - Spain - Sweden - Switzerland - United Kingdom - United States of America

www.st.com