



## **1 Introduction**

This document describes the features and operation of the STM8 integrated bootloader program. This code embedded in the system memory of the device (ROM memory) allows memories, including Flash program, data EEPROM, and RAM, to be written into the device using the standard serial interfaces LINUART/UART/USART, SPI, and CAN.

The bootloader code is similar for all STM8 versions. However, even though a peripheral may be present in a product, the product may not support it (for example the SPI is not supported in 128 Kbyte devices). In addition, different STM8 device types support different peripherals (see [Table 5: Serial interfaces associated with STM8 devices](#) for detailed information).

For further information on the STM8 family features, pinout, electrical characteristics, mechanical data and ordering information, please refer to the STM8 datasheets.

# Contents

- 1 Introduction ..... 1**
- 2 Bootloader introduction ..... 6**
  - 2.1 Bootloader activation ..... 7
- 3 Peripheral settings ..... 11**
  - 3.1 USART/UARTs settings ..... 11
    - 3.1.1 LINUART/UARTs in “reply” mode settings ..... 11
  - 3.2 SPI settings ..... 12
  - 3.3 CAN settings ..... 13
- 4 Bootloader command set ..... 14**
  - 4.1 Get command ..... 15
    - 4.1.1 Get command via USART/LINUART/UART1/ UART2/UART3 ..... 15
    - 4.1.2 Get command via SPI ..... 17
    - 4.1.3 Get command via CAN ..... 19
  - 4.2 Read memory command ..... 21
    - 4.2.1 Read memory command via USART/LINUART/UART1/UART2/UART3 21
    - 4.2.2 Read memory command via SPI ..... 23
    - 4.2.3 Read memory command via CAN ..... 26
  - 4.3 Erase memory command ..... 27
    - 4.3.1 Erase memory command via USART/LINUART/UART1/UART2/  
UART3 ..... 28
    - 4.3.2 Erase memory command via SPI ..... 31
    - 4.3.3 Erase memory command via CAN ..... 33
  - 4.4 Write memory command ..... 35
    - 4.4.1 Write memory command via USART/LINUART/UART1/UART2/UART3 36
    - 4.4.2 Write memory command via SPI ..... 38
    - 4.4.3 Write memory command via CAN ..... 41
  - 4.5 Speed command ..... 43
    - 4.5.1 Speed command via CAN ..... 43
  - 4.6 Go command ..... 45
    - 4.6.1 Go command via USART/LINUART/UART1/UART2/UART3 ..... 45
    - 4.6.2 Go command via SPI ..... 47



---

4.6.3	Go command via CAN .....	49
4.7	Sector codes .....	50
4.8	Software model (STM8A/L/S) .....	56
4.8.1	RAM erase/write routines .....	57
<b>5</b>	<b>Error management .....</b>	<b>58</b>
<b>6</b>	<b>Programming time .....</b>	<b>59</b>
<b>Appendix A</b>	<b>How to upload ROP protected device .....</b>	<b>60</b>
A.1	Rules for upgrading ROP protected devices .....	60
<b>Appendix B</b>	<b>Bootloader entry points .....</b>	<b>61</b>
<b>Appendix C</b>	<b>SPI peripheral timing options .....</b>	<b>62</b>
C.1	SPI with busy state checking .....	62
C.2	Modified erase/write RAM routines .....	62
<b>Appendix D</b>	<b>PC software support .....</b>	<b>63</b>
<b>Appendix E</b>	<b>Bootloader UART limitation .....</b>	<b>64</b>
E.1	Description .....	64
E.1.1	UART automatic baudrate calculation .....	64
E.1.2	Description of UART limitation .....	64
E.2	Workaround for UART limitation .....	65
<b>Appendix F</b>	<b>Limitations and improvements versus bootloader versions .....</b>	<b>66</b>
<b>Revision history</b>	<b>.....</b>	<b>68</b>

## List of tables

Table 1.	STM8 subfamilies featuring a bootloader . . . . .	6
Table 2.	STM8 subfamilies without bootloader . . . . .	7
Table 3.	Bootloader versions for which bootloader activation flowchart is valid . . . . .	7
Table 4.	Initial checking . . . . .	10
Table 5.	Serial interfaces associated with STM8 devices. . . . .	11
Table 6.	Bootloader commands . . . . .	14
Table 7.	Bootloader codes . . . . .	14
Table 8.	Examples of delay . . . . .	39
Table 9.	STM8 sector codes. . . . .	50
Table 10.	Error table . . . . .	58
Table 11.	USART/LINUART/UART1/UART2/UART3 programming times . . . . .	59
Table 12.	SPI programming time . . . . .	59
Table 13.	CAN programming time . . . . .	59
Table 14.	Bootloader entry points. . . . .	61
Table 15.	Description of limitation, improvements and added features . . . . .	66
Table 16.	Document revision history . . . . .	68

## List of figures

Figure 1.	Bootloader activation flow chart . . . . .	8
Figure 2.	CAN frame . . . . .	13
Figure 3.	Get command via USART/LINUART/UART1/UART2/UART3 - host side . . . . .	15
Figure 4.	Get command via USART/LINUART/UART1/UART2/UART3 - device side. . . . .	16
Figure 5.	Get command via SPI - host side . . . . .	17
Figure 6.	Get command via SPI - device side . . . . .	18
Figure 7.	Get command via CAN - host side . . . . .	19
Figure 8.	Get command via CAN - device side . . . . .	20
Figure 9.	Read memory command via USART/LINUART/UART1/UART2/UART3 - host side . . . . .	21
Figure 10.	Read memory command via USART/LINUART/UART1/UART2/UART3 - device side . . . . .	22
Figure 11.	Read memory command via SPI - host side . . . . .	23
Figure 12.	Read memory command via SPI - device side. . . . .	25
Figure 13.	Read memory command via CAN - host side. . . . .	26
Figure 14.	Read memory command via CAN - device side. . . . .	26
Figure 15.	Erase memory command via USART/LINUART/UART1/UART2/UART3 - host side. . . . .	28
Figure 16.	Erase memory command via USART/LINUART/UART1/UART2/UART3 - device side. . . . .	30
Figure 17.	Erase memory command via SPI - host side . . . . .	31
Figure 18.	Erase memory command via SPI - device side . . . . .	32
Figure 19.	Erase memory command via CAN - host side . . . . .	33
Figure 20.	Erase memory command via CAN - device side . . . . .	34
Figure 21.	Write memory command via USART/LINUART/UART1/UART2/UART3 - host side . . . . .	36
Figure 22.	Write memory command via USART/LINUART/UART1/UART2/UART3 - device side . . . . .	37
Figure 23.	Write memory command via SPI - host side. . . . .	38
Figure 24.	Write memory command via SPI - device side. . . . .	40
Figure 25.	Write memory command via CAN - host side. . . . .	41
Figure 26.	Write memory command via CAN - device side . . . . .	42
Figure 27.	Speed command via CAN - host side. . . . .	43
Figure 28.	Speed command via CAN - device side . . . . .	44
Figure 29.	Go command via USART/LINUART/UART1/UART2/UART3 - host side . . . . .	45
Figure 30.	Go command via USART/LINUART/UART1/UART2/UART3 - device side . . . . .	46
Figure 31.	Go command via SPI - host side . . . . .	47
Figure 32.	Go command via SPI - device side. . . . .	48
Figure 33.	Go command via CAN - host side . . . . .	49
Figure 34.	Go command via CAN - device side. . . . .	49
Figure 35.	Delay elimination in modified RAM routines . . . . .	62
Figure 36.	"Flash loader demonstrator" software. . . . .	63

## 2 Bootloader introduction

The main task of the bootloader is to download the application program into the internal memories through the integrated peripherals (UARTs, SPI, or CAN) without using the SWIM protocol and dedicated hardware. Data are provided by any device (host) which is capable of sending information through one of the above-mentioned serial interfaces.

The bootloader permits downloading of application software into the device memories, including RAM, program and data memory, using standard serial interfaces. It is a complementary solution to programming via the SWIM debugging interface.

The bootloader code is stored in the internal boot ROM memory. After a reset, the bootloader code checks whether the program memory is virgin or whether a specific option byte is set allowing code modifications.

If these conditions are not fulfilled, the bootloader resumes and the user application is started.

In case of a successful check the bootloader is executed.

When the bootloader procedure starts, the main tasks are:

- Polling all supported serial interfaces to check which peripheral is used
- Programming code, data, option bytes and/or vector tables at the address(es) received from the host.

Each STM8 device embeds a specific bootloader code which is common to a whole group of STM8 devices. The correspondence between STM8 groups and STM8 part numbers is given in [Table 1](#). Group names are used all over this user manual.

**Table 1. STM8 subfamilies featuring a bootloader**

STM8 group	STM8 part numbers
STM8A/S-128K	STM8AF52xx, STM8AF6269/8x/Ax, STM8AF51xx, STM8AF6169/7x/8x/9x/Ax, STM8S20xxx
STM8A/S-32K	STM8AF622x/4x, STM8AF6266/68, STM8AF612x/4x, STM8AF6166/68, STM8S105xx
STM8L-64k	STM8L15xx8, STM8L15xR6, STM8L16xx8
STM8L-32K	STM8L15xC4, STM8L15xK4, STM8L15xG4, STM8L15xC6, STM8L15xK6, STM8L15xG6 (x = 1 or 2)
STM8L-8K	STM8L15xC2, STM8L15xK2, STM8L15xG2, STM8L15xC3, STM8L15xK3, STM8L15xG3 (x = 1 or 2)

[Table 2](#) gives the list of STM8 devices without embedded bootloader (no ROM bootloader is implemented inside the microcontroller). When using these devices, you have to write your own bootloader code and save it in the UBC program area (refer to STM8S and STM8A families reference manual for information on the UBC area).

**Table 2. STM8 subfamilies without bootloader**

STM8 group	STM8 part numbers
STM8A/S-8K	STM8Sx03xx
STM8L-8K	STM8L101xx

## 2.1 Bootloader activation

The STM8 hardware reset vector is located at the beginning of the boot ROM (0x00 6000), while the other interrupt vectors are in the Flash program memory starting at address 0x00 8004.

The device executes the boot ROM (jumps inside the boot ROM area) and after checking certain address locations (see [Table 4: Initial checking on page 10](#)), it starts to execute the bootloader or the user code defined by the reset vector (0x00 8000).

The bootloader activation flowchart is described in [Figure 1: Bootloader activation flow chart](#). In previous bootloader versions, a return to the “wait for SYNCHR” state (see dashed line in [Figure 1](#)) was performed when the “Flash virgin” test was positive. In newer versions, it has been replaced by a software (SW) reset to prevent the customer firmware from remaining in a infinite loop (e.g. due to EMC disturbance). This bootloader modification is referred to as “EMC lockup protection” in [Table 15](#). [Table 3](#) lists the bootloader versions for which the dashed line was replaced by a SW reset.

The bootloader version number of a given device is obtained by the “Get command” (see [Section 4.1: Get command](#)). The bootloader version is represented by a two-digit binary-coded decimal (BCD) number (with a decimal point between the two digits) which is coded into one byte in the “Get command” result. For example, 0x21 version byte is bootloader version 2.1.

**Table 3. Bootloader versions for which bootloader activation flowchart is valid**

STM8 group	Bootloader version
STM8A/S-128K	v2.2
STM8A/S-32K	v1.3
STM8L-64K	v1.0
STM8L-32K	v1.2
STM8L-8K	v1.0

Figure 1. Bootloader activation flow chart

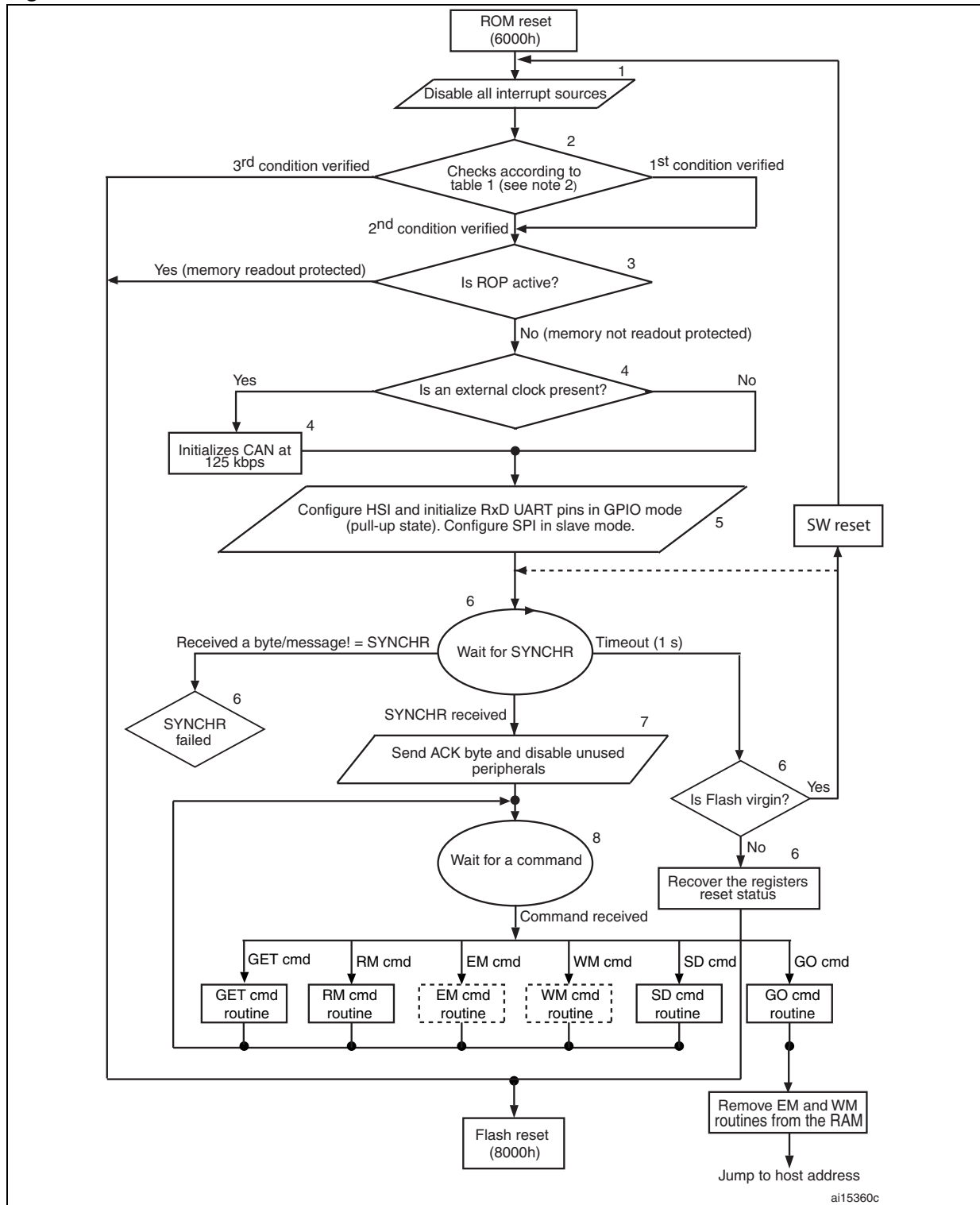

1. See [Flow chart description on page 9](#) for explanation of points 1 to 8.
2. See [Table 4: Initial checking](#).
3. Dotted routines are loaded in RAM by the host. They are removed by the go command before jumping to the Flash program memory to execute an application.





### Flow chart description

1. Disable all interrupt sources.
2. The host can start the bootloader process according to checks shown in [Table 4](#) (in keeping with the content of the first Flash program memory location (0x00 8000) and “bootloader enable” option bytes). The host checks the following bootloader start conditions:

Condition 1: the host checks if the device memory is empty by inspecting the content of address 0x00 8000 (reset vector). If the content is not equal to 0x82 or 0xAC, the device is recognized as being empty and the bootloader remains active and waits for host commands without timeouts.

Condition 2: the host checks if the bootloader option bytes (two bytes) are set to enable the bootloader or not. The bootloader is enabled with a value of 0x55AA and disabled by all other values (see the device datasheets for the bootloader option byte locations). If the option bytes are enabled, the bootloader remains active and waits for host commands with a 1-second timeout. If the host does not send a command within this timeout, the bootloader jumps directly to the application user vector (jump to address 0x00 8000).

Condition 3: If the option bytes disable the bootloader (by a value different from 0x55AA), the bootloader jumps directly to the application user vector (jump to address 0x00 8000).

The above checking process is summarized in [Table 4](#).
3. When readout protection (ROP) is active, the Flash program memory is readout protected. In this case, the bootloader stops and the user application starts. If ROP is inactive, the bootloader continues to be executed (see [Appendix A: How to upload ROP protected device](#)).
4. The CAN peripheral can only be used if an external clock (8 MHz, 16 MHz, or 24 MHz) is present. It is initialized at 125 kbps. The UARTs and SPI peripherals do not require an external clock.
5. Set the high speed internal RC oscillator (HSI) to 16 MHz and initialize the UARTs receiver pins in input pull-up mode in the GPIO registers. Initialize the SPI in slave mode. Then, wait 4 ms for I/O pin voltage level stabilization. It is recommended that the host waits 10 ms from the STM8 reset before sending the SYNCHR byte/message. This is the time needed for bootloader initialization.

6. Interface polling: The bootloader polls all peripherals waiting for a synchronization byte/message (SYNCHR = 0x7F) within a timeout of 1 second. If a timeout occurs, either the Flash program memory is virgin in which case it waits for a synchronization byte/message in an infinite loop through a software reset, or the Flash program memory is not virgin and the bootloader restores the registers' reset status and jumps to the memory address given by the reset vector (located at 0x00 8000). For the bootloader versions listed in [Table 3](#), a software reset is generated after a timeout has elapsed, in case the Flash program memory is empty (this is because it is safer to stay in an infinite loop if there is a hardware chip error).

*Note:* When synchronization fails (the bootloader receives a byte/message different to 'SYNCHR' = 0x7F) two different situations can be distinguished according to the peripheral:

*With the UART peripherals, a device reset or power-down is necessary before synchronization can be tried again. Refer to [Appendix E: Bootloader UART limitation](#)*

*With the CAN or SPI peripheral, the user can continue to poll the interfaces until a synchronization or a timeout occurs.*

7. If the synchronization message is received by the UARTs, the bootloader automatically detects the baud rate, initializes the UART and goes to step 8 below. If the synchronization message is received by the CAN or SPI, the bootloader goes directly to step 8 below.

*Note:* Once one of the available interfaces receives the synchronization message, all others are disabled.

8. Waiting for commands: Commands are checked in an infinite loop and executed. To exit from the bootloader, the host has to send a 'GO' command. When this is done, the bootloader removes the EM and WM routines from the RAM memory and jumps to the address selected by the host.

*Note:* To be able to write/erase data in Flash and EEPROM the host must write into RAM executable routines for writing and erasing. Those routines (\*.s19 files) are provided with the bootloader. Host must upload those routines at address 0xA0. See section [4.8.1: RAM erase/write routines](#) for more information.

**Table 4. Initial checking**

Checks	Program memory byte location [0x00 8000]	Bootloader check option bytes [BL_OPT] <sup>(1)</sup>	Actual Flash program memory status -> Flash action
1 <sup>st</sup>	[0x00 8000] <> (0x82 or 0xAC)	[BL_OPT] = 0x00 XXXX	Flash program memory virgin. -> jump to bootloader
2 <sup>nd</sup>	[0x00 8000] <> (0x82 or 0xAC)	[BL_OPT] = 0x00 55AA	Flash program memory already written, bootloader enabled by option bytes. -> jump to bootloader
3 <sup>rd</sup>	[0x00 8000] <> (0x82 or 0xAC)	[BL_OPT] <> 0x00 55AA	Flash program memory already written, bootloader disabled by option bytes. -> jump to Flash program memory reset

1. See device datasheet for the [BL\_OPT] location in the option byte area memory map.

*Note:* After interface initialization, the ROP bit is checked to avoid non-authorized reading of the Flash program memory and data EEPROM.

## 3 Peripheral settings

This section describes the hardware settings of the STM8 communication peripherals:

- UARTs/LINUART
- SPI
- CAN

*Note:* During bootloading only one peripheral (first addressed) is enabled. All others are disabled.

**Table 5. Serial interfaces associated with STM8 devices<sup>(1)</sup>**

STM8 groups	Serial interface
STM8A-128K	USART, LINUART (in “reply” mode), CAN
STM8A-32K	LINUART, SPI
STM8S-128K	UART1, UART3 (in “reply” mode), CAN
STM8S-32K	UART2 (in “reply” mode), SPI
STM8L-8K	UART, SPI
STM8L-32K	UART
STM8L-64K	UART1, UART2, UART3 (in “reply” mode), SPI1, SPI2

1. The above table reflects only current bootloader versions and device states.

### 3.1 USART/UARTs settings

This peripheral supports asynchronous serial communication.

The USART/UARTs settings are:

- Data frame: 1 start bit, 8 data bit, 1 parity bit set to even, 1 stop bit
- Baud rate: The baud rate is automatically detected by the bootloader. When the user sends the synchronization byte, 0x7F, the bootloader automatically detects the baud rate and sets the USART/UARTs to the same baud rate. Maximum baud rate = 1 Mbps (115200 baud for STM8L-64K); minimum baud rate = 4800 bps.

To perform the automatic speed detection, the RxD line must be stable in the application board (internal pull-up is enabled on the RxD line by the bootloader).

#### 3.1.1 LINUART/UARTs in “reply” mode settings

Settings are:

- Data frame: 1 start bit, 8 data bit, no parity bit, 1 stop bit
- Baud rate: The baud rate is automatically detected by the bootloader. When the user sends the synchronization byte 0x7F, the bootloader automatically detects the baud rate and sets the UARTs to the same baud rate. Maximum baud rate = 550 kbps (115200 baud for STM8L-64K); minimum baud rate = 4800 bps.

To perform automatic speed detection, the RxD line must be stable in the application board (internal pull-up is enabled on the RxD line by the bootloader).

### Reply mode

The host must reply to all the bytes sent from the bootloader. If TxD and RxD lines share the same physical medium (for example, 1-wire communication), then host replies are not necessary since RxD and TxD pins coincide.

## 3.2 SPI settings

The SPI settings are:

- 8 data bit, MSB first
- Bit rate: Set by the host which acts as a master
- Peripheral set in slave mode with software management of NSS
- Data polarity: CPOL = 0 (SCK to 0 when idle), CPHA = 0 (the first clock transition is the first data capture edge).

- Note:*
- 1 Before sending a 'token' byte, the host has to wait for a delay of a specified period of time. If this period is not quantified, it is equal to 6  $\mu$ s.
  - 2 The SPI peripheral is accessible via SPI\_SCK, SPI\_MOSI and SPI\_MISO pins.

### 3.3 CAN settings

To address additional devices on the same bus, the CAN protocol provides a standard identifier field (11-bit) and an optional extended identifier field (18-bit) in the frame.

[Figure 2](#) shows the CAN frame that uses the standard identifier only.

**Figure 2. CAN frame**

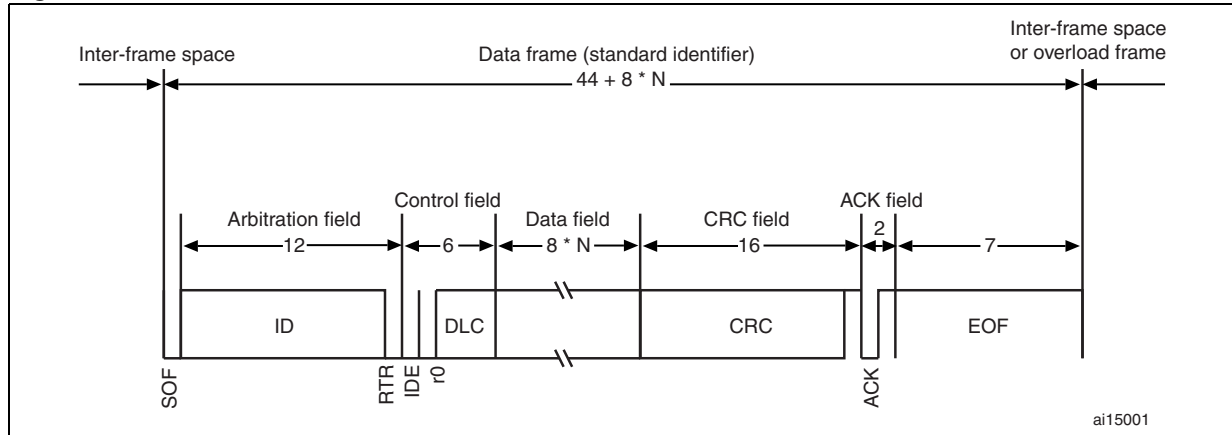

The CAN settings are as follows:

- Standard identifier (not extended)
- Bit rate  
By default, it is 125 kbps. The runtime can be changed via the speed command to achieve a maximum bitrate of 1 Mbps.

The transmit settings (from the STM8 to the host) are:

- Tx mailbox0: On
- Tx mailbox1 and Tx mailbox2: Off
- Tx identifier: 0x02
- Outgoing messages contain 1 data byte

The receive settings (from the host to the STM8) are:

- The synchronization byte, 0x7F, is in the RX identifier and not in the data field
- The RX identifier depends on the command (0x00, 0x03, 0x11, 0x21, 0x31, 0x43)
- Error checking: If the error field (bit [6:4] in the CESR register) is different from 000b, the message is discarded and a NACK is sent to the host.
- In FIFO overrun condition, the message is discarded and a NACK is sent to the host.
- Incoming messages can contain from 1 to 8 data bytes.

*Note:* The CAN peripheral is accessible via CAN\_TX and CAN\_RX pins.

## 4 Bootloader command set

The commands supported by the bootloader are listed in [Table 6](#) below.

**Table 6. Bootloader commands**

Command	Command code	Command description
Get	0x00	Gets the version and the allowed commands supported by the current version of the bootloader
Read memory	0x11	Reads up to 256 bytes of memory starting from an address specified by the host
Erase memory	0x43	Erases from one to all of the Flash program memory/data EEPROM sectors
Write memory	0x31	Writes up to 128 bytes to RAM or the Flash program memory/data EEPROM starting from an address specified by the host
Speed	0x03	Allows the baud rate for CAN runtime to be changed
Go	0x21	Jumps to an address specified by the host to execute a loaded code

**Table 7. Bootloader codes**

Name	Code	Description
SYNCH	0x7F	Synchronization byte
ACK	0x79	Acknowledge
NACK	0x1F	No acknowledge
Token	0xFF	Any byte which the host sends to the bootloader via the SPI interface to receive an answer from the bootloader (it is necessary to put data into the SPI when it is needed to receive data - SPI clock generation) The usual token value is 0x00.
BUSY	0xAA	Busy flag status

When the bootloader receives a command via the UARTs, CAN or SPI peripherals, the general protocol is as follows:

1. The bootloader sends an ACK byte (0x79) to the host and waits for an address and for a checksum byte, both of which are checked when received.
2. When the address is valid and the checksum is correct, the bootloader transmits an ACK byte (0x79), otherwise it transmits a NACK byte (0x1F) and aborts the command. The bootloader waits for the number of bytes to be transmitted (N bytes) and for its complemented byte (checksum).
  - If the checksum is correct, it then carries out the command, starting from the received address.
  - If the checksum is incorrect, it sends a NACK (0x1F) byte before aborting the command.

The bootloader protocols via the UARTs, and SPI are identical on the device side, but differ regarding the host. A token byte is needed when sending each byte to the host via SPI (see [Figure 5](#), [Figure 11](#), [Figure 17](#), [Figure 23](#), and [Figure 31](#)). The bootloader protocol via CAN differs from all other peripherals.

The following sections are organized as follows:

- Commands via USART/LINUART/UART1/ UART2/ UART3
- Commands via SPI
- Commands via CAN

## 4.1 Get command

The get command allows the host to get the version of the bootloader and the supported commands. When the bootloader receives the get command, it transmits the bootloader version and the supported command codes to the host.

### 4.1.1 Get command via USART/LINUART/UART1/ UART2/UART3

Figure 3. Get command via USART/LINUART/UART1/UART2/UART3 - host side

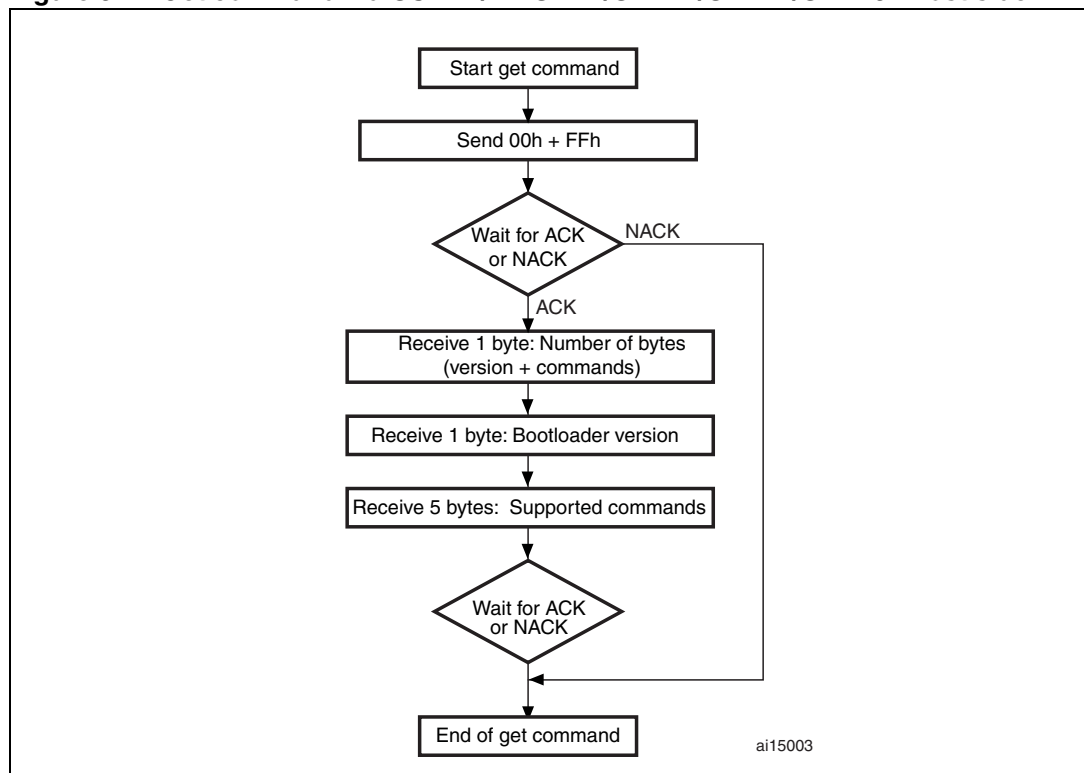

#### The host sends the bytes as follows

- Byte 1: 0x00 - Command ID
- Byte 2: 0xFF - Complement

Figure 4. Get command via USART/LINUART/UART1/UART2/UART3 - device side

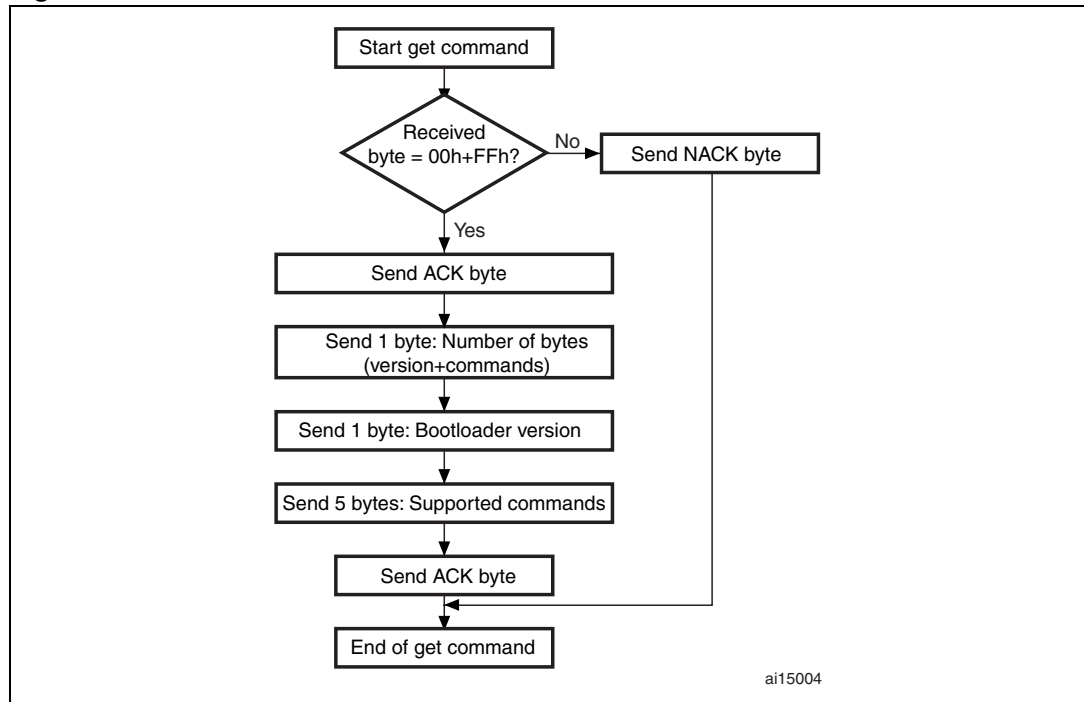

**The STM8 sends the bytes as follows**

- Byte 1: ACK (after the host has sent the command)
- Byte 2:  $N = 5$  = the number of bytes to be sent -1 ( $1 \leq N + 1 \leq 256$ )
- Byte 3: Bootloader version ( $0 < \text{version} \leq 255$ )
- Byte 4: 0x00 - Get command
- Byte 5: 0x11 - Read memory command
- Byte 6: 0x21 - Go command
- Byte 7: 0x31 - Write memory command
- Byte 8: 0x43 - Erase memory command
- Byte 9: ACK



4.1.2 Get command via SPI

Figure 5. Get command via SPI - host side

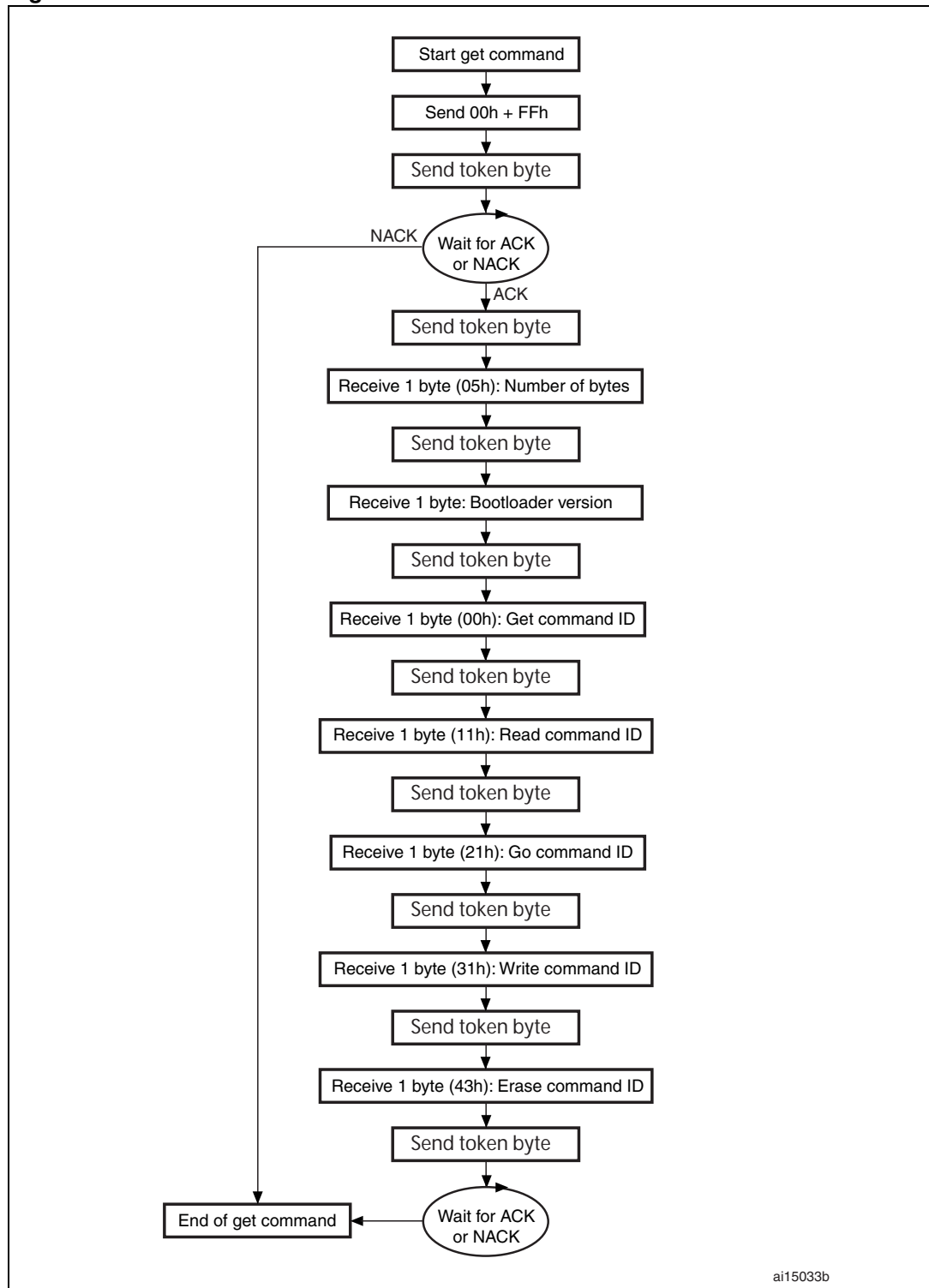

ai15033b

**The host sends the bytes as follows**

- Byte 1: 0x00 - Command ID
- Byte 2: 0xFF - Complement
- Byte 3 (token): 0xXY; host waits for ACK or NACK
- Byte 4 (token): 0xXY; host waits for 0x05
- ...
- Byte 11 (token): 0xXY; host waits for ACK or NACK.

**Figure 6. Get command via SPI - device side**

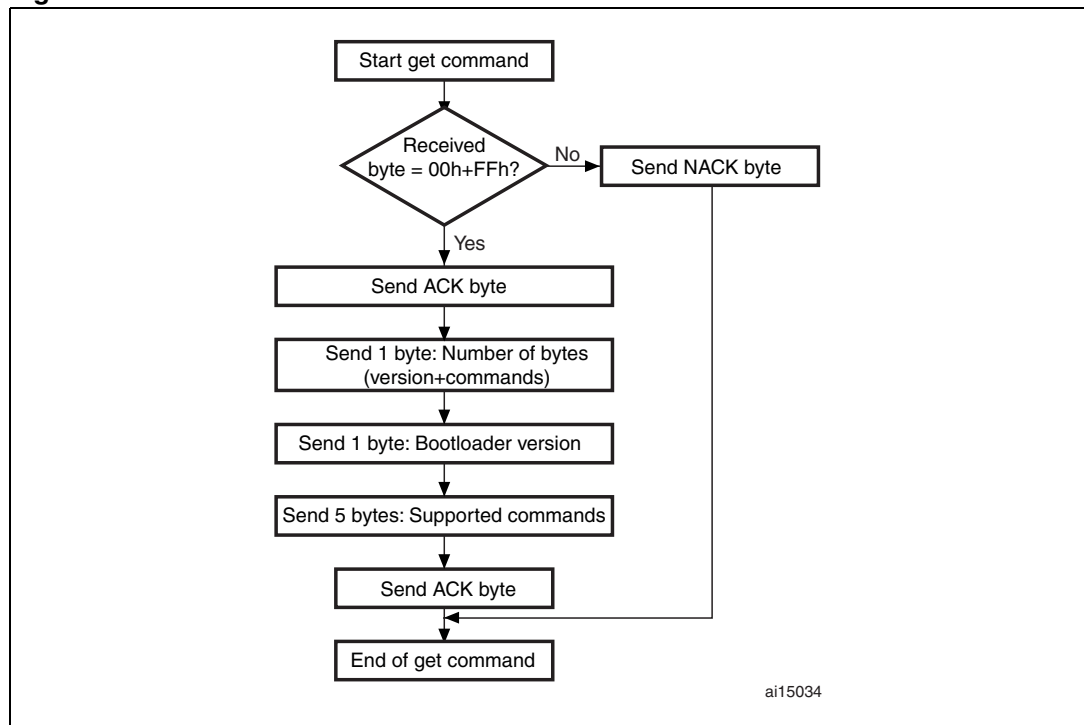

**The STM8 sends the bytes as follows**

- Byte 1: ACK
- Byte 2: N = 5 = the number of bytes to be sent -1 (1 <= N +1 <= 256)
- Byte 3: Bootloader version (0 < version <= 255)
- Byte 4: 0x00 - Get command
- Byte 5: 0x11 - Read memory command
- Byte 6: 0x21 - Go command
- Byte 7: 0x31 - Write memory command
- Byte 8: 0x43 - Erase memory command
- Byte 9: ACK

### 4.1.3 Get command via CAN

Figure 7. Get command via CAN - host side

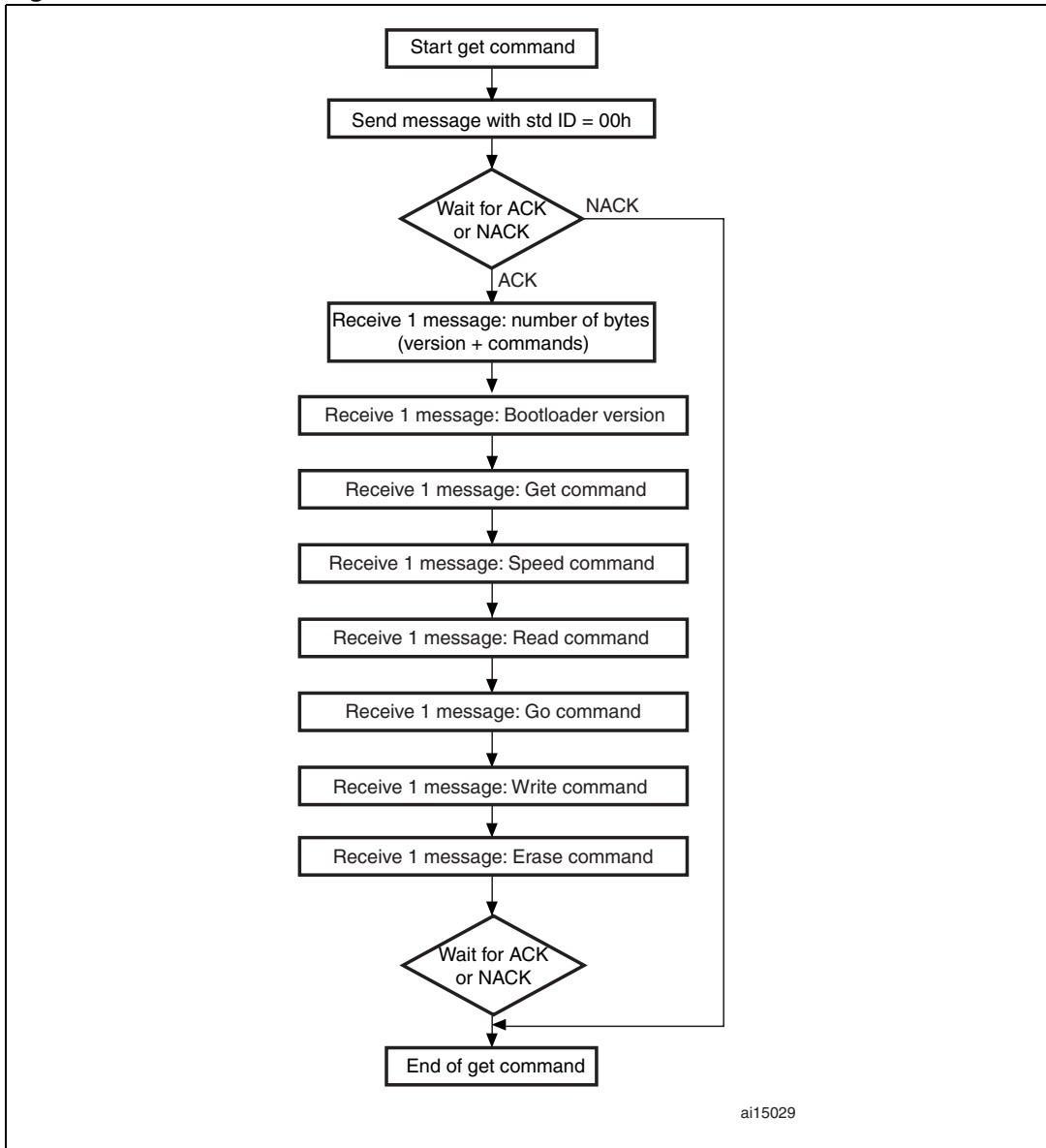

**The host sends the messages as follows**

Command message: Std ID = 0x00, data length code (DLC) = 'not important'.

**Figure 8. Get command via CAN - device side**

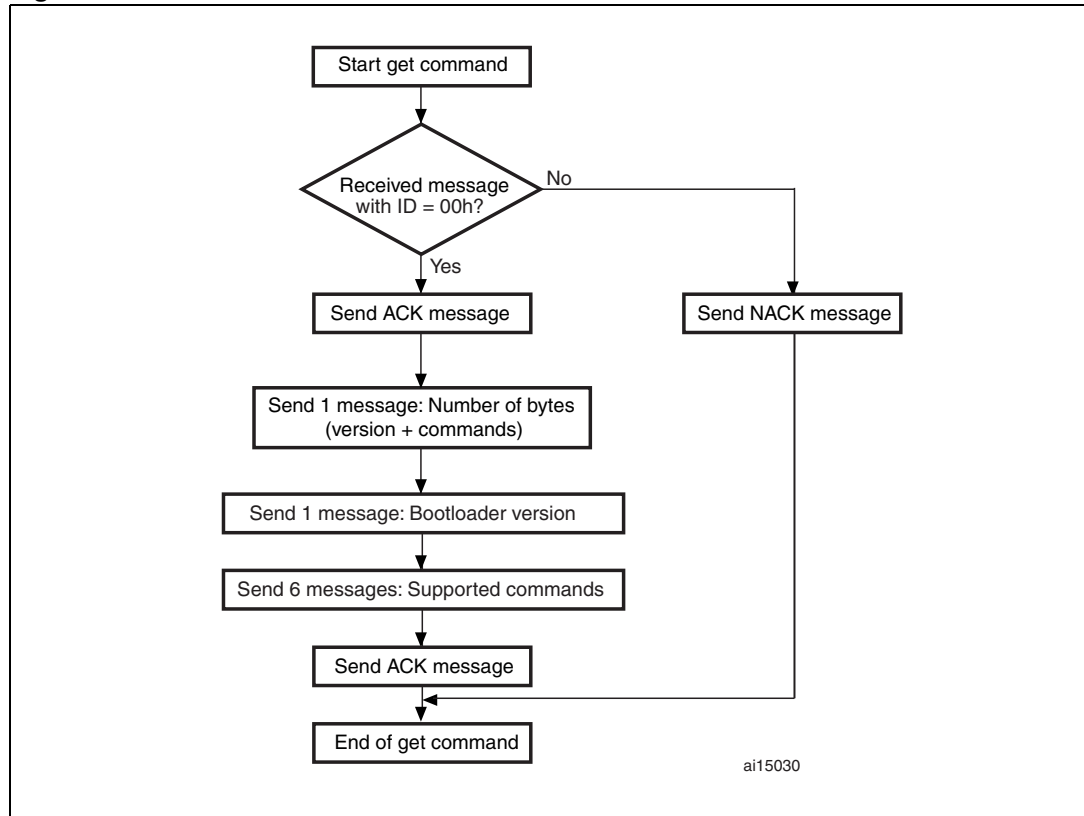

**The STM8 sends the messages as follows**

- Message 1: Std ID = 0x02, DLC = 1, data = ACK
- Message 2: Std ID = 0x02, DLC = 1 data = N = 6 = the number of bytes to be sent -1 (1 ≤ N + 1 ≤ 256)
- Message 3: Std ID = 0x02, DLC = 1, data = bootloader version (0 < version ≤ 255)
- Message 4: Std ID = 0x02, DLC = 1, data = 0x00 - Get command
- Message 5: Std ID = 0x02, DLC = 1, data = 0x03 - Speed command
- Message 6: Std ID = 0x02, DLC = 1, data = 0x11 - Read memory command
- Message 7: Std ID = 0x02, DLC = 1, data = 0x21 - Go command
- Message 8: Std ID = 0x02, DLC = 1, data = 0x31 - Write memory command
- Message 9: Std ID = 0x02, DLC = 1, data = 0x43 - Erase memory command
- Message 10: Std ID = 0x02, DLC = 1, data = ACK

## 4.2 Read memory command

The read memory command is used to read the memory (RAM, Flash program memory/data EEPROM or registers). When the bootloader receives the read memory command, it transmits the needed data ((N + 1) bytes) to the host, starting from the received address.

### 4.2.1 Read memory command via USART/LINUART/UART1/UART2/UART3

Figure 9. Read memory command via USART/LINUART/UART1/UART2/UART3 - host side

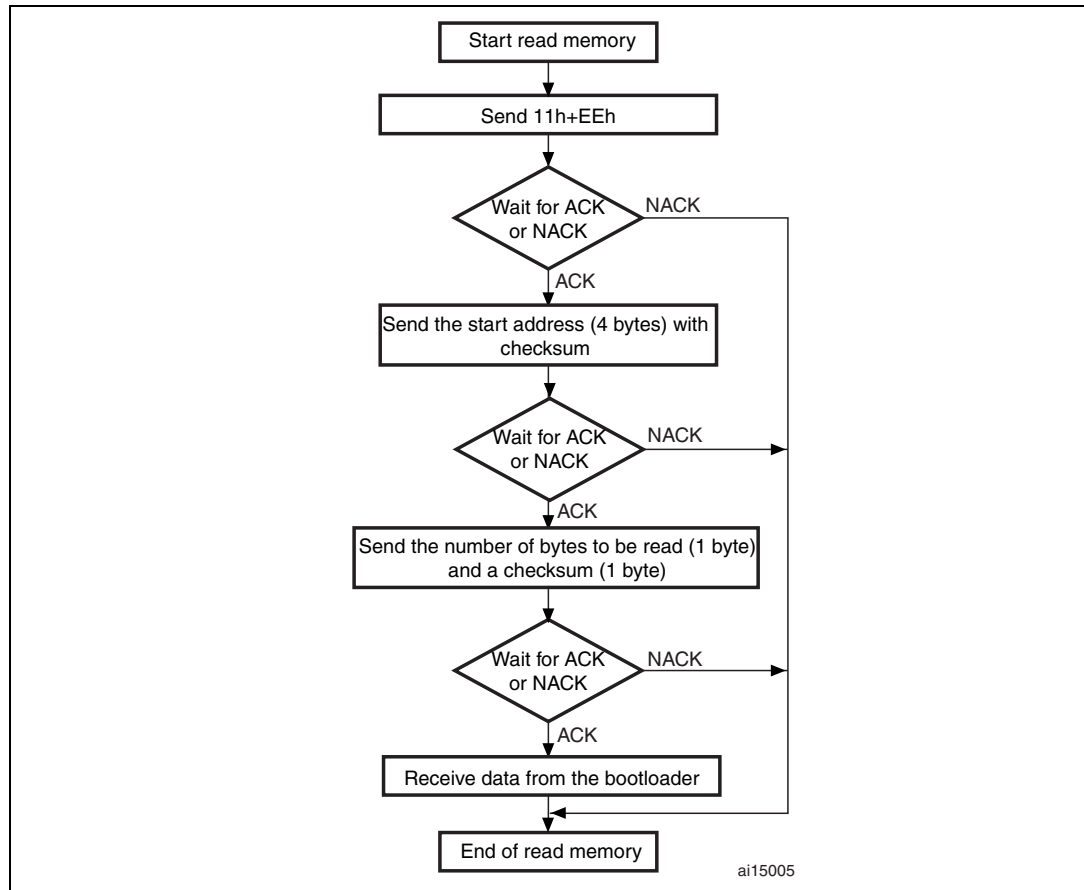

1. The valid addresses are RAM, Flash program memory/data EEPROM, and register addresses (see product datasheets). If the bootloader receives an invalid address, an error occurs (see [Table 10: Error table on page 58](#)).

**The host sends the bytes to the STM8 as follows**

- Bytes 1-2: 0x11+0xEE
- Bytes 3-6: The start address (32-bit address)
  - Byte 3 = MSB
  - Byte 6 = LSB
- Byte 7: Checksum = XOR (byte 3, byte 4, byte 5, byte 6)
- Byte 8: The number of bytes to be read -1 ( $0 \leq N \leq 255$ )
- Byte 9: Checksum (complement of byte 8)

**Figure 10. Read memory command via USART/LINUART/UART1/UART2/UART3 - device side**

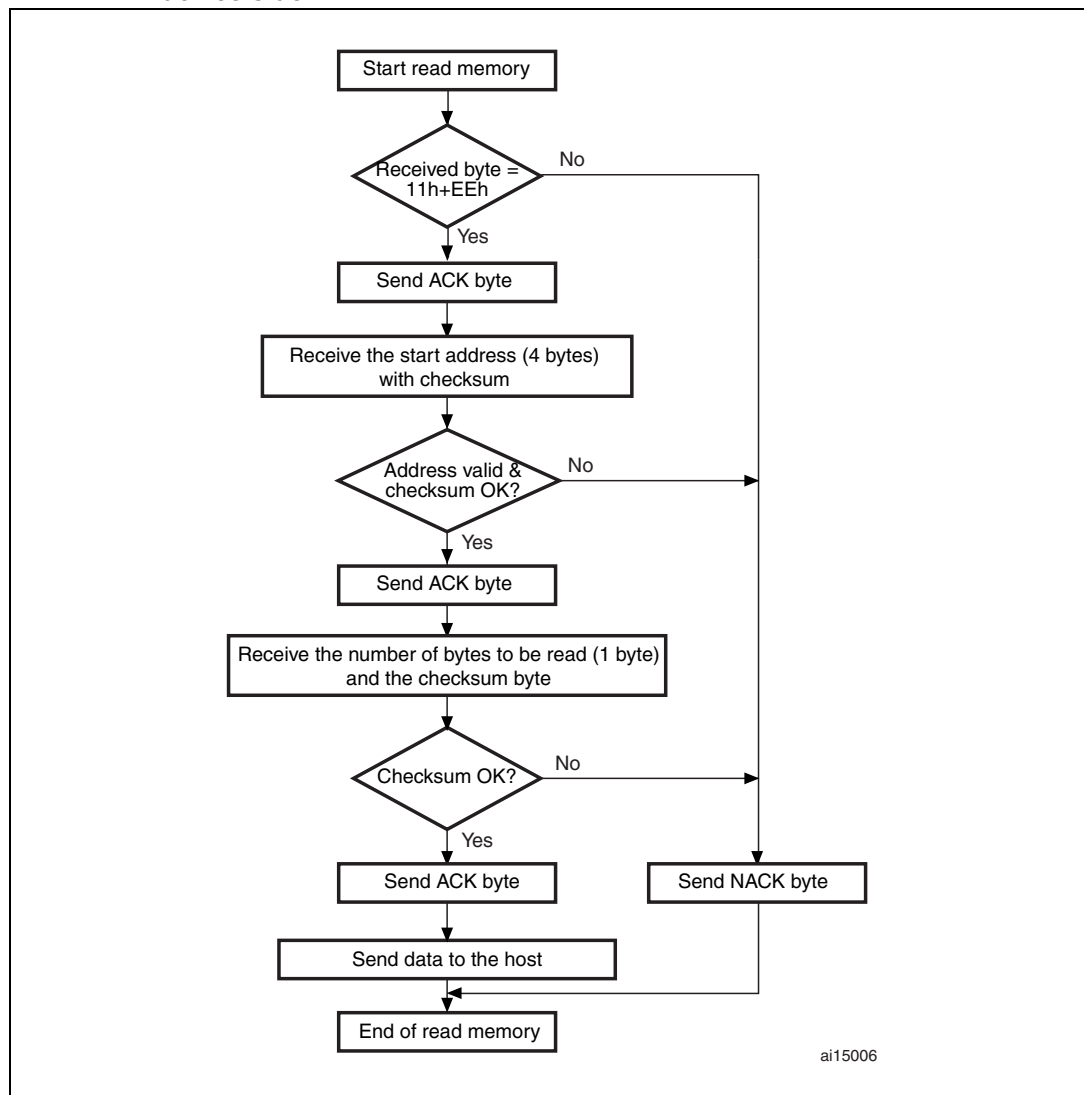

### 4.2.2 Read memory command via SPI

Figure 11. Read memory command via SPI - host side

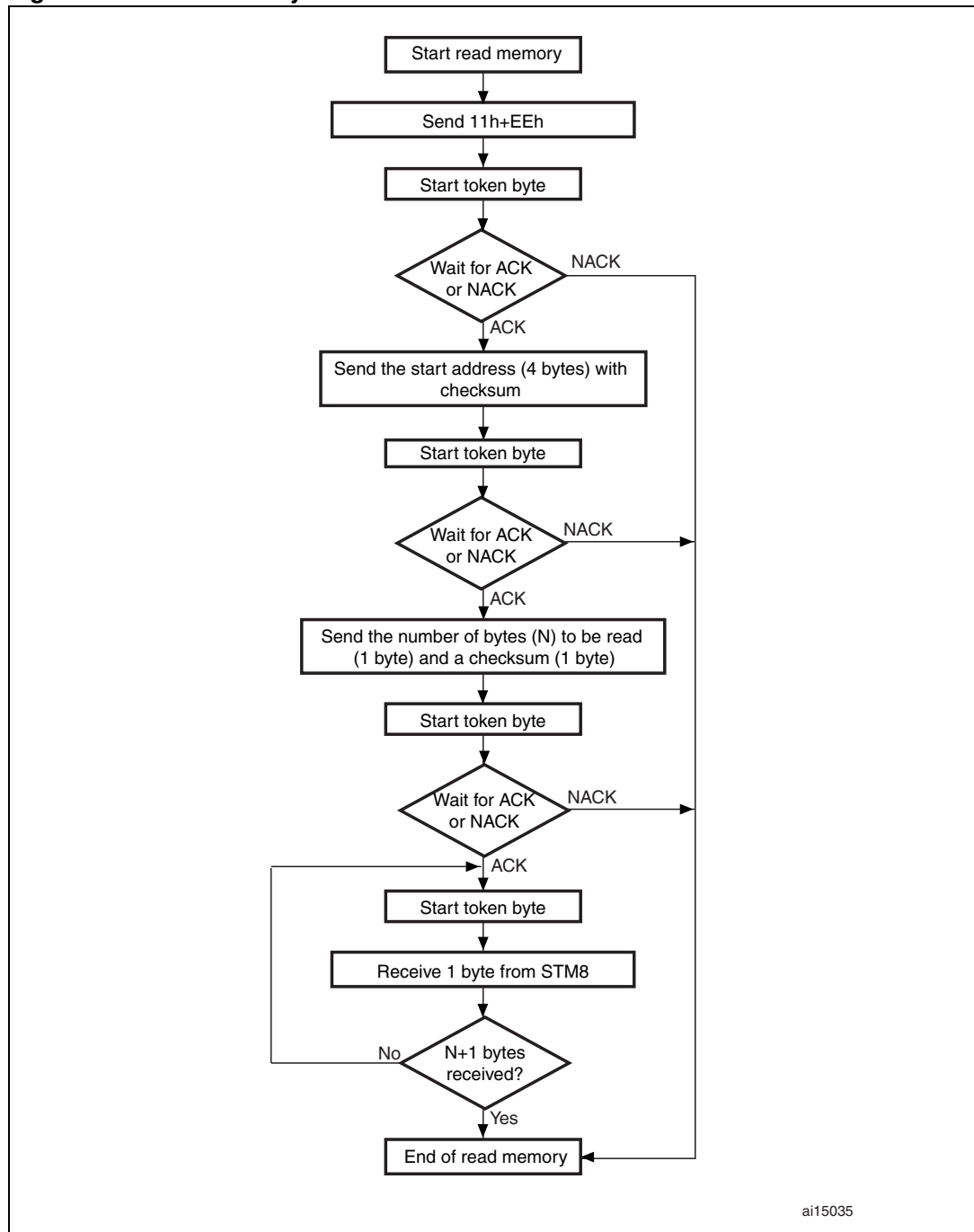

1. The valid addresses are RAM, Flash program memory/data EEPROM, and register addresses (see product datasheets). If the bootloader receives an invalid address, an error occurs (see [Table 10: Error table on page 58](#)).

**The host sends the bytes to the STM8 as follows**

Byte 1:	0x11	- Command ID
Byte 2:	0xEE	- Complement
Byte 3 (token):	0xXY;	host waits for ACK or NACK
Bytes 4 to 7:	The start address (32-bit address)	
	Byte 4 = MSB	
	Byte 7 = LSB	
Byte 8:	Checksum = XOR (byte 4, byte 5, byte 6, byte 7)	
Byte 9 (token):	0xXY;	host waits for ACK or NACK
Byte 10:	The number of bytes to be read -1 ( $0 \leq N \leq 255$ )	
Byte 11:	Checksum (complement of byte 10)	
Byte 12 (token):	0xXY;	host waits for the 1 <sup>st</sup> data byte
Byte 12+N (token):	0xXY;	host waits for the N+1 <sup>th</sup> data byte



Figure 12. Read memory command via SPI - device side

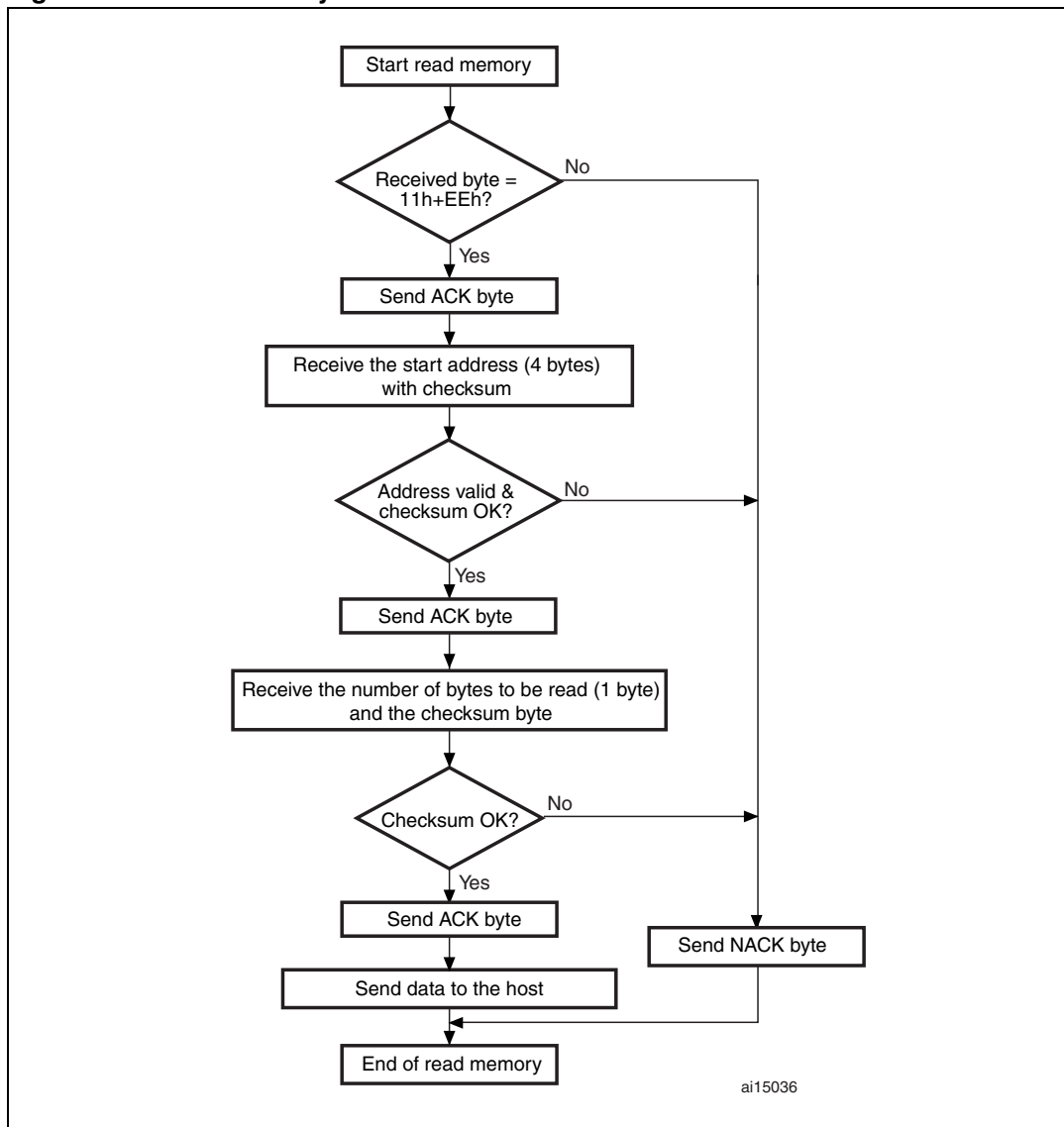

### 4.2.3 Read memory command via CAN

The CAN message sent by the host is as follows:

- The ID contains the command type (0x11)
- The data field contains a destination address (4 bytes, byte 1 is the MSB and byte 4 is LSB of the address) and the 'number of bytes' (N) to be read.

**Figure 13. Read memory command via CAN - host side**

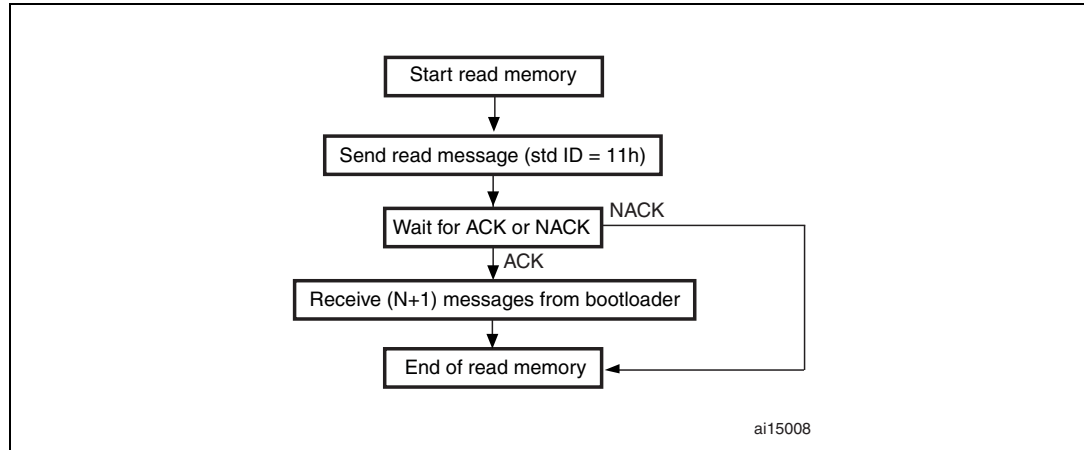

1. The valid addresses are RAM, Flash program memory/data EEPROM, and register addresses (see product datasheets). If the bootloader receives an invalid address, an error occurs (see [Table 10: Error table on page 58](#)).

#### The host sends the messages as follows

Command message: Std ID = 0x11, DLC = 0x05, data = MSB, 0xXX, 0xYY, LSB, N (where  $0 < N \leq 255$ ).

**Figure 14. Read memory command via CAN - device side**

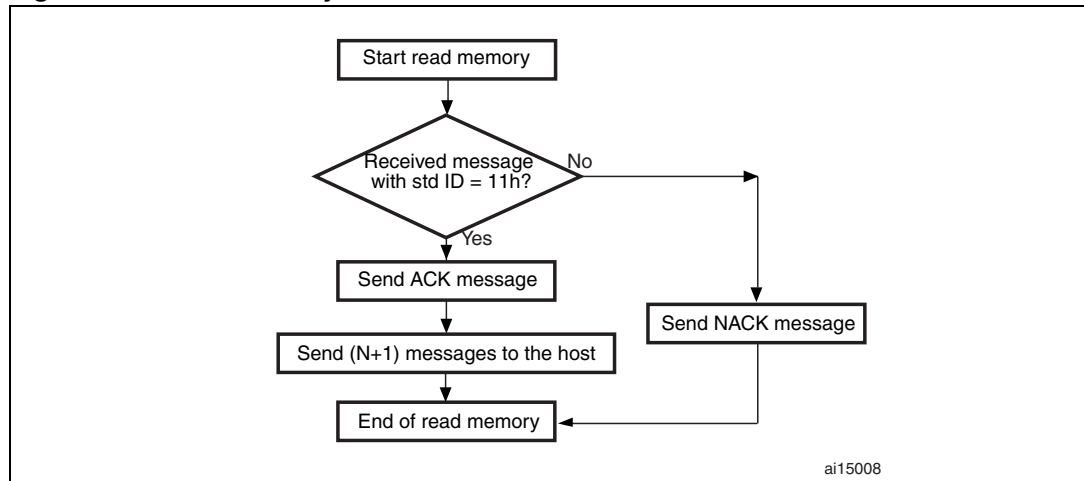

**The STM8 sends the messages as follows**

ACK message: Std ID = 0x02, DLC = 1, data = ACK

Data message 1: Std ID = 0x02, DLC = 1, data = 0xXX

Data message 2: Std ID = 0x02, DLC = 1, data = 0xXX

...

Data message (N+1): Std ID = 0x02, DLC = 1, data = 0xXX

*Note:* The bootloader sends as many data messages as bytes which can be read.

### 4.3 Erase memory command

The erase memory command allows the host to erase sectors of the Flash program memory/data EEPROM.

The bootloader receives the erase command message, when the ID contains the command type (0x43) and the data field contains the sectors to be erased (see [Table 9: STM8 sector codes on page 50](#)). A sector size is 1 Kbyte, therefore, the granularity with the erase command is eight blocks (1 block = 128 bytes). If the host wants to erase one byte only, the write command (write 0x00) can be used.

**Erase memory command description**

1. The bootloader receives one byte which contains the number (N) of sectors to be erased. N is device dependent.
2. Then, the bootloader receives (N + 1) bytes, where each byte contains a sector code (see [Table 9: STM8 sector codes on page 50](#)).

### 4.3.1 Erase memory command via USART/LINUART/UART1/UART2/UART3

Figure 15. Erase memory command via USART/LINUART/UART1/UART2/UART3 - host side

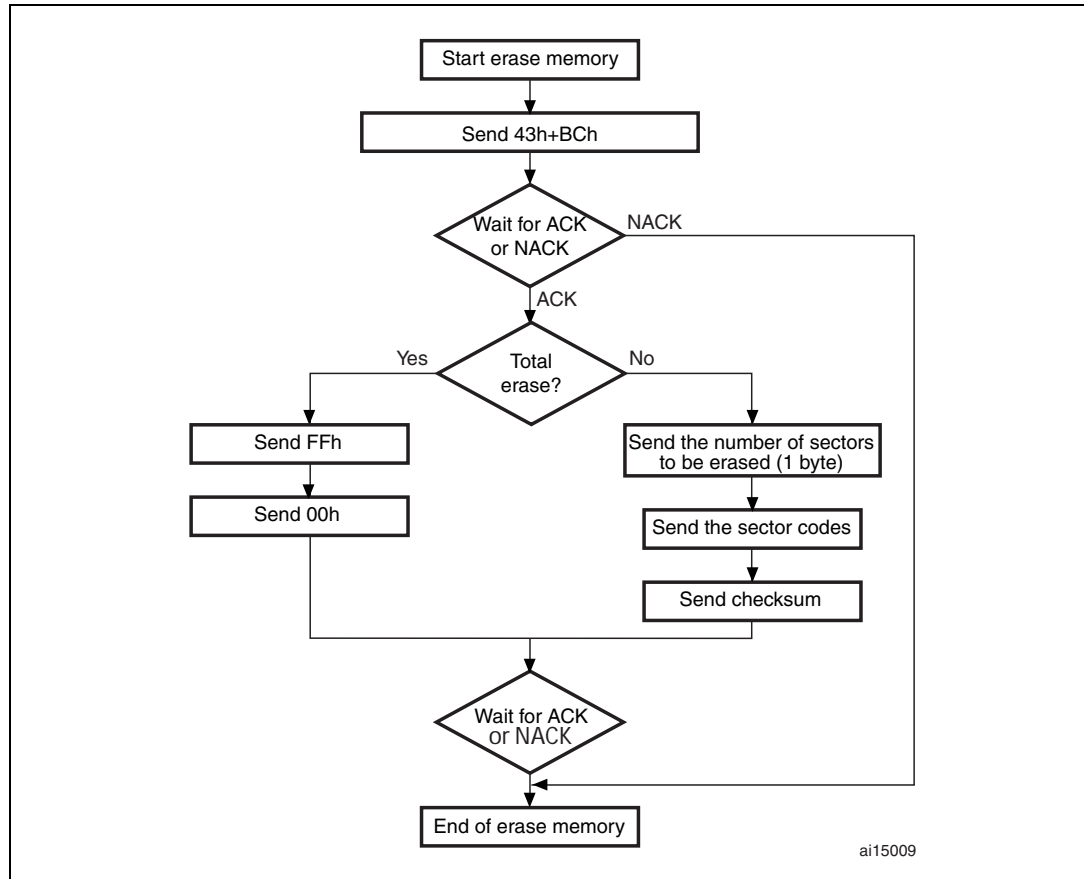

1. "Total erase" erases program and data EEPROM. The bootloader erases the memory sector by sector.
2. A sector is 1 Kbyte for all devices. Therefore, the granularity of the erase command 8 blocks. To erase one byte, the write command can be used by writing 0x00.

---

**Warning:** If the host sends an erase command that includes some correct sector code and one or more forbidden sector codes (see [Table 9: STM8 sector codes](#)), the command fails.

---

**The host sends the bytes as follows**

- Byte 1:                   0x43           - Command ID
- Byte 2:                   0xBC           - Complement
- Byte 3:                   0xFF or number of sectors to be erased ( $0 \leq N \leq M$ );  
if  $N > M$ , a cmd\_error occurs in the bootloader, after which the  
bootloader receives  $N + 1$  data bytes and the checksum (i.e. the  
host completes the command).

**Note:**

*N is product dependent.*

*$M = (\text{size of the Flash program memory in Kbyte}) + (\text{size of data EEPROM in Kbyte}) - 1.$*

*Example STM8S-128K:*

*$M = 129$ , because Flash program memory is 128 Kbytes and data EEPROM is 2 Kbytes  
( $128 + 2 - 1$ ).*

*Example STM8S-32K:  $M = 32$ , because Flash program memory is 32 Kbytes and data  
EEPROM is 1 Kbyte ( $32 + 1 - 1$ ).*

Byte 4 or  $N+1$  bytes:   0x00 or ( $N+1$  bytes and then checksum:  $\text{XOR}(N, [N+1 \text{ data bytes}])$ ).

Figure 16. Erase memory command via USART/LINUART/UART1/UART2/UART3 - device side

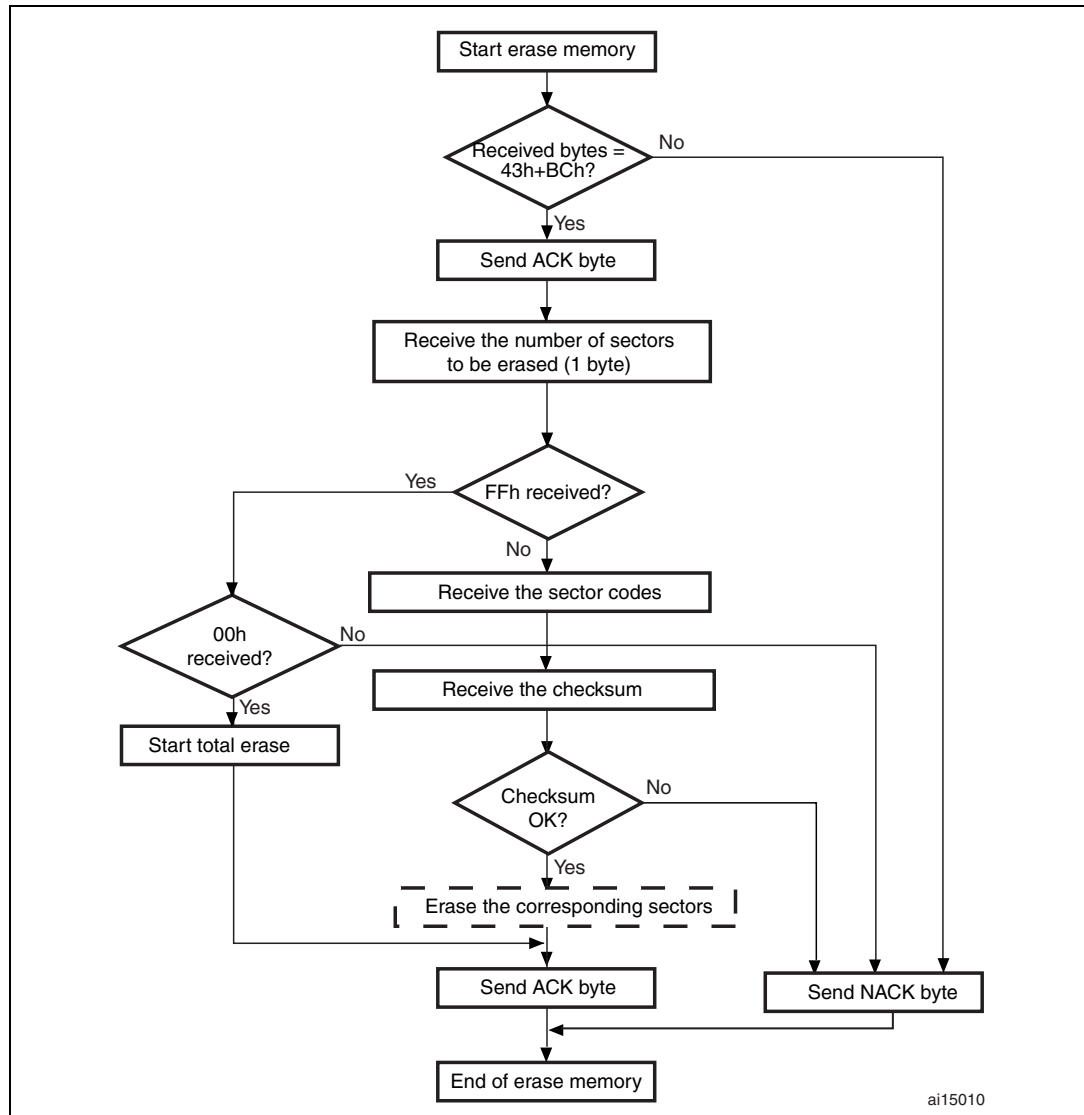

1. 'Erase the corresponding sectors' routine is performed in RAM. The user therefore has to download the erase routine in RAM before sending an erase command. Note that for some bootloader versions this is not necessary (see [4.8.1: RAM erase/write routines](#)).

### 4.3.2 Erase memory command via SPI

Figure 17. Erase memory command via SPI - host side

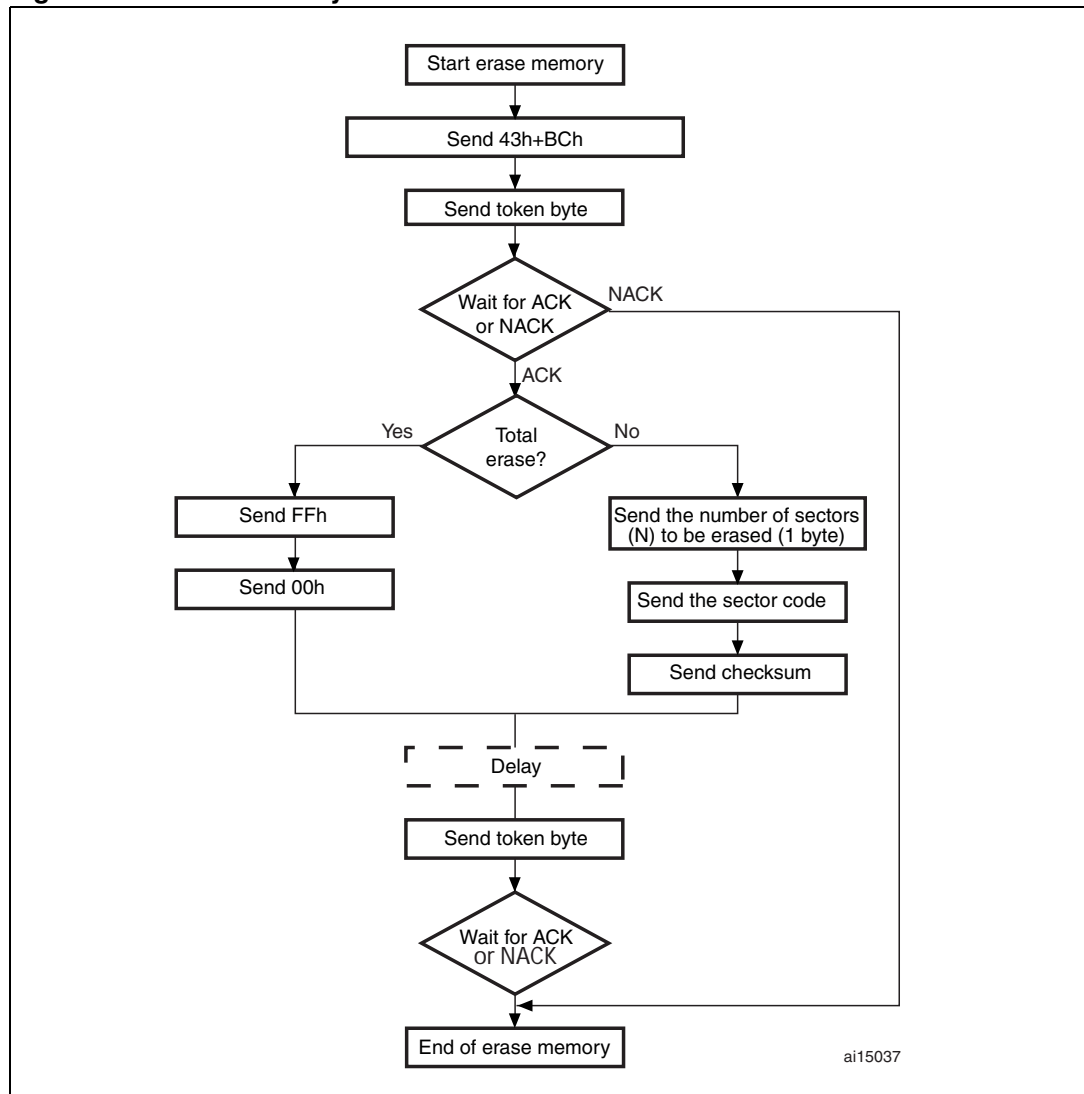

1. When using the erase command via SPI, it is necessary to wait for a brief time interval (see 'delay' in Figure 17 above) before sending the last token byte. This delay interval depends on the SPI baud rate and on the number of sectors (N) to be erased. Delay = 13 \* (N + 1)[ms], where 0 ≤ N ≤ 32. N = 32 in the case of total erase. See also Appendix C: SPI peripheral timing options.

**The host sends the bytes as follows**

- Byte 1: 0x43 - Command ID
- Byte 2: 0xBC - Complement
- Byte 3 (token): 0xXY; host waits for ACK or NACK
- Byte 4: 0xFF or number of sectors to be erased ( $0 \leq N \leq 32$ )  
If  $N > 32$  a 'cmd\_error' occurs.
- Byte 5 or N+1 bytes: 0x00 or (N+1 bytes and then checksum:  
XOR(N,[N+1 data bytes])
- Last byte (token): 0xXY; host waits for ACK or NACK.

**Figure 18. Erase memory command via SPI - device side**

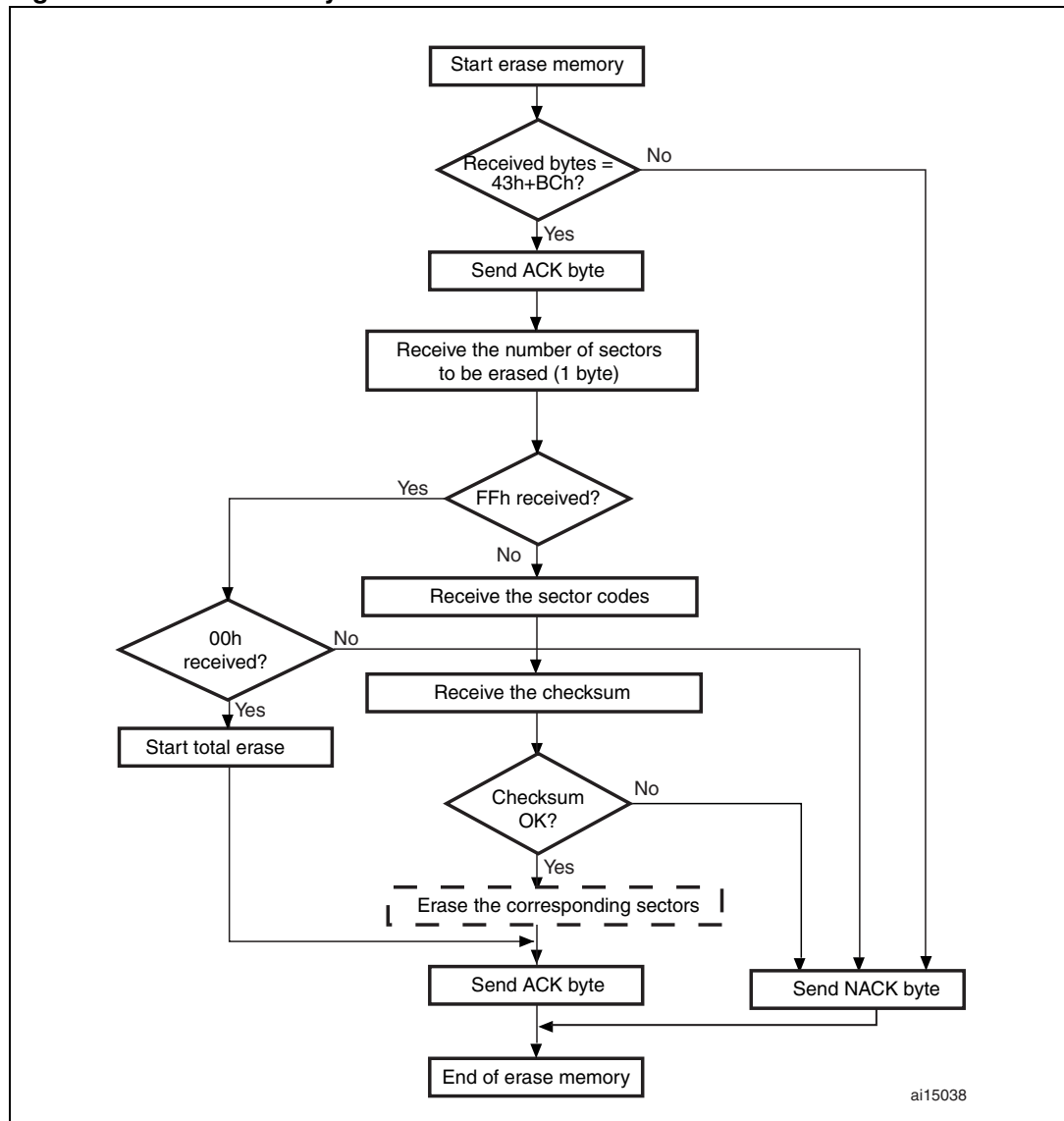

1. 'Erase the corresponding sectors' routine is performed in RAM. The user therefore has to download the erase routine in RAM before sending an erase command. Note that for some bootloader versions this is not necessary (see 4.8.1: RAM erase/write routines).



### 4.3.3 Erase memory command via CAN

Figure 19. Erase memory command via CAN - host side

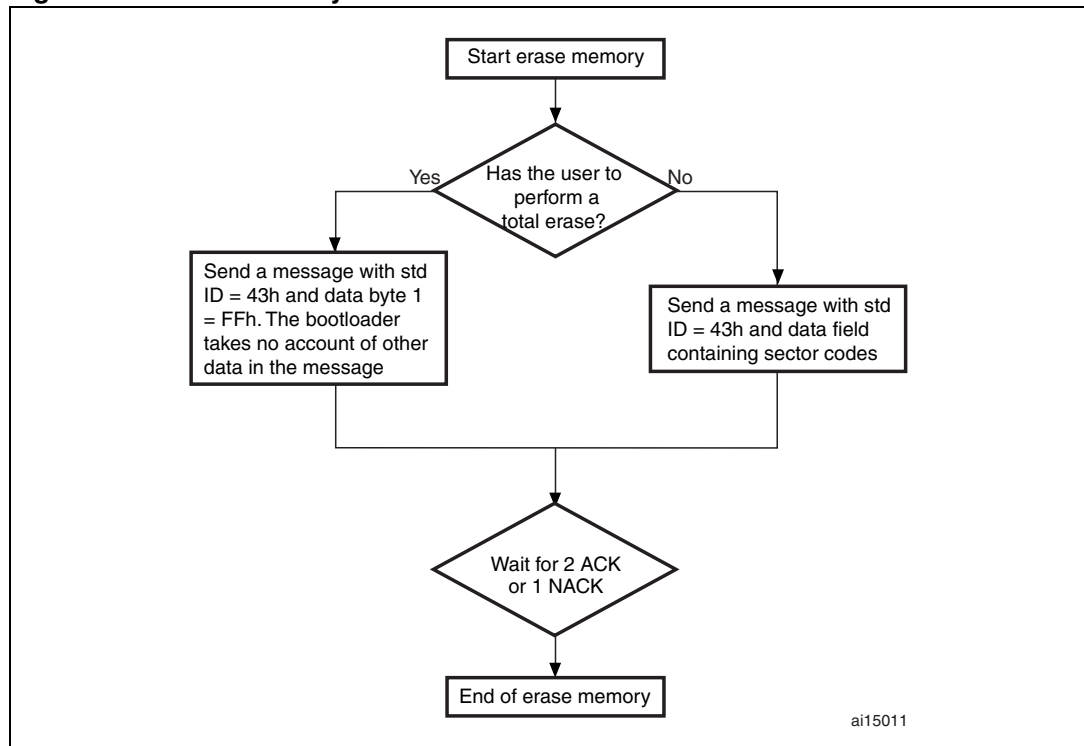

1. The bootloader erases the memory sector by sector.
2. A sector is 1 Kbyte for all devices. Therefore, the granularity of the erase command 8 blocks. To erase one byte, the write command can be used by writing 0x00.

**Warning:** If the host sends an erase command that includes some correct sector code and one or more forbidden sector codes (see [Table 9: STM8 sector codes](#)), the command fails and no block is erased.

#### The host sends the message as follows

Total erase message: Std ID = 0x43, DLC = 0x01, data = 0xFF.

Erase sector by sector message: Std ID = 0x43, DLC = 0x01 to 0x08, data = see [Table 9: STM8 sector codes](#).

Figure 20. Erase memory command via CAN - device side

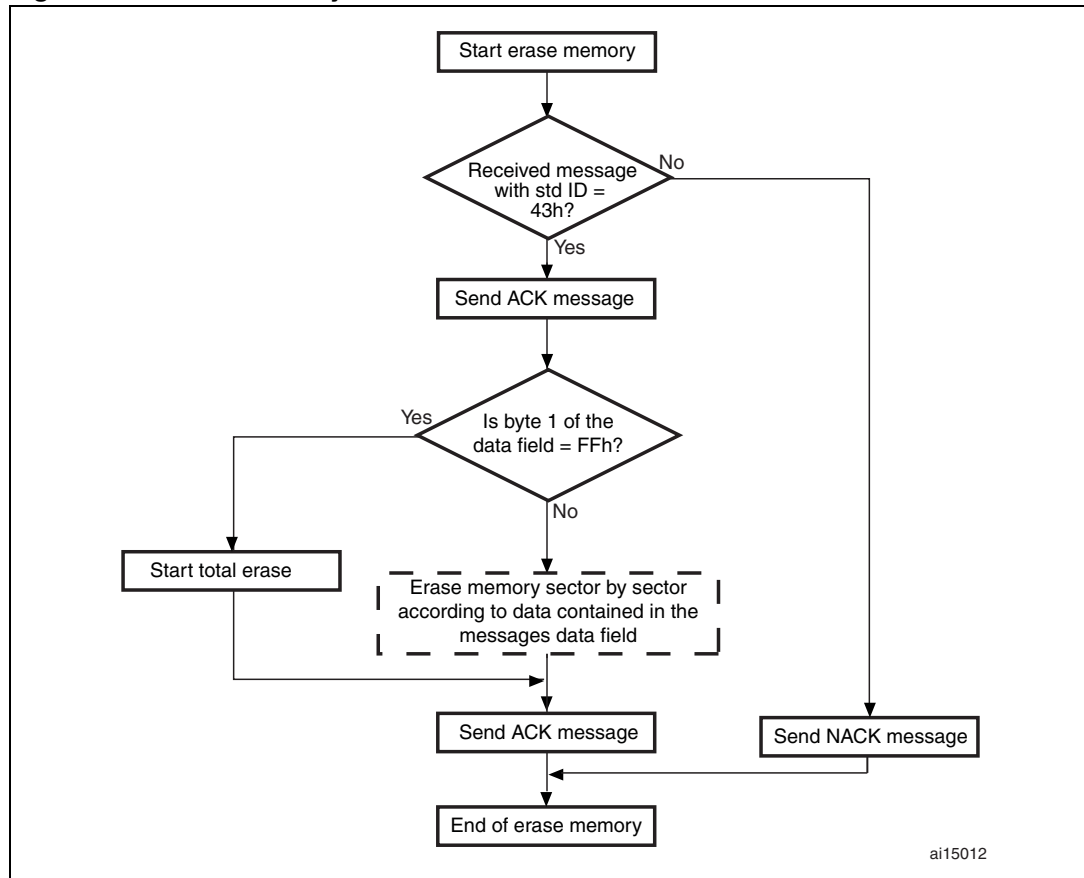

ai15012

1. 'Erase memory sector by sector according to data contained in the message field' is performed in RAM. The user therefore has to download the erase routine in RAM before sending an erase command. Note that for some bootloader versions this is not necessary (see [4.8.1: RAM erase/write routines](#)).

## 4.4 Write memory command

The write memory command allows the host to write data into any memory address (RAM, Flash program memory/data EEPROM or registers) starting from the received address. Incoming data are always written in RAM before being loaded in the memory locations decided by the host. The bootloader then checks whether the host wants to write in RAM or in the Flash program memory/data EEPROM.

The maximum length of the block to be written for the STM8 is 128 data bytes. To write the data in the Flash program memory/data EEPROM locations, the bootloader performs two different write operations:

1. **WordWrite/FastWordWrite:** Writes a byte in the Flash program memory/data EEPROM. It is used when the number of bytes (N) sent from the host is less than 128. In this case the bootloader performs the operation N times.
2. **BlockWrite:** Writes a block in the Flash program memory/data EEPROM. It is used when the number of bytes (N) sent from the host is 128 and the destination address is an integer module of 128. In other words, to use this operation, the block sent from the host has to be aligned with a memory block. If not aligned, the byte write operation is used (which is slower).

### 4.4.1 Write memory command via USART/LINUART/UART1/UART2/UART3

Figure 21. Write memory command via USART/LINUART/UART1/UART2/UART3 - host side

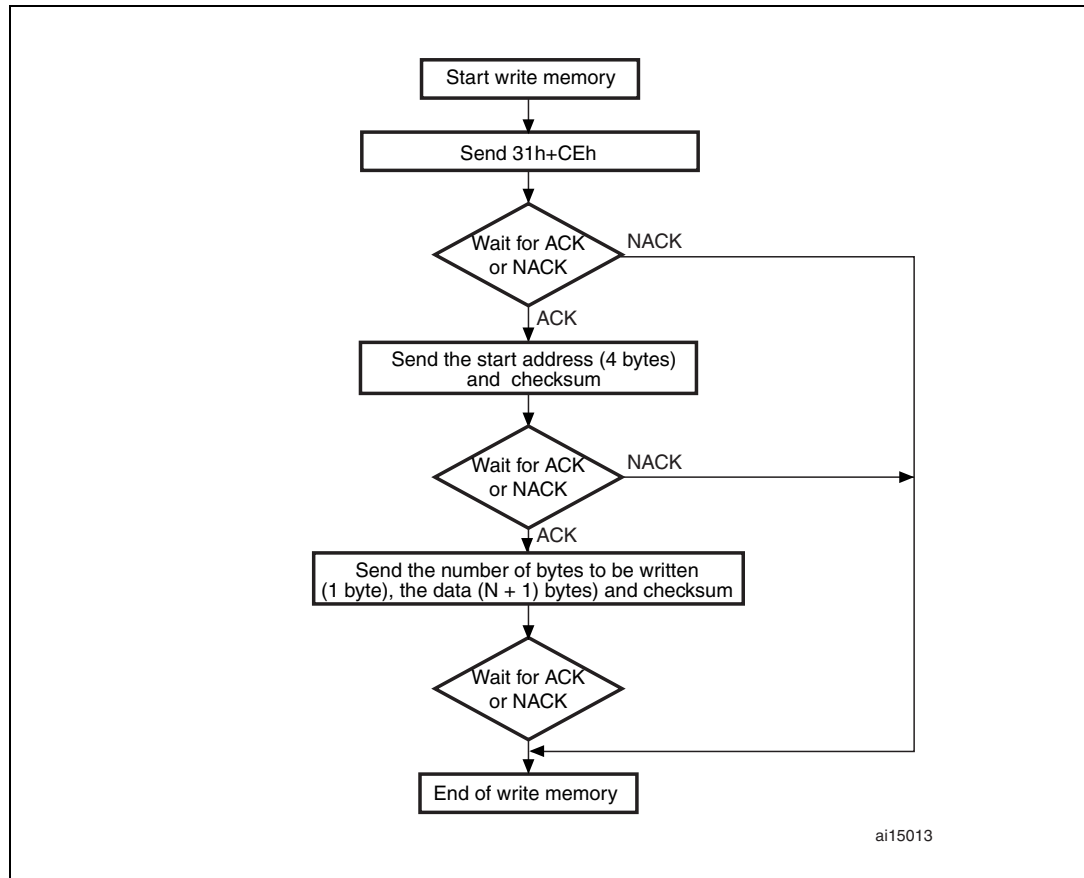

1. See product datasheets for valid addresses. If the start address is invalid, an add\_error occurs (see [Table 10: Error table on page 58](#)).

**The host sends the bytes as follows**

- Byte 1: 0x31 - Command ID
- Byte 2: 0xCE - Complement
- Bytes 3-6: The start address (32-bit address)
  - Byte 3 = MSB
  - Byte 6 = LSB
- Byte 7: Checksum = XOR (byte 3, byte 4, byte 5, byte 6)
- Byte 8: The number of bytes to be received -1: N = 0 ... 127  
If N > 127, a cmd\_error occurs in the bootloader.
- N+1 bytes: Max 128 data bytes
- Checksum byte: XOR (N,[N+1 data bytes]).

Figure 22. Write memory command via USART/LINUART/UART1/UART2/UART3 - device side

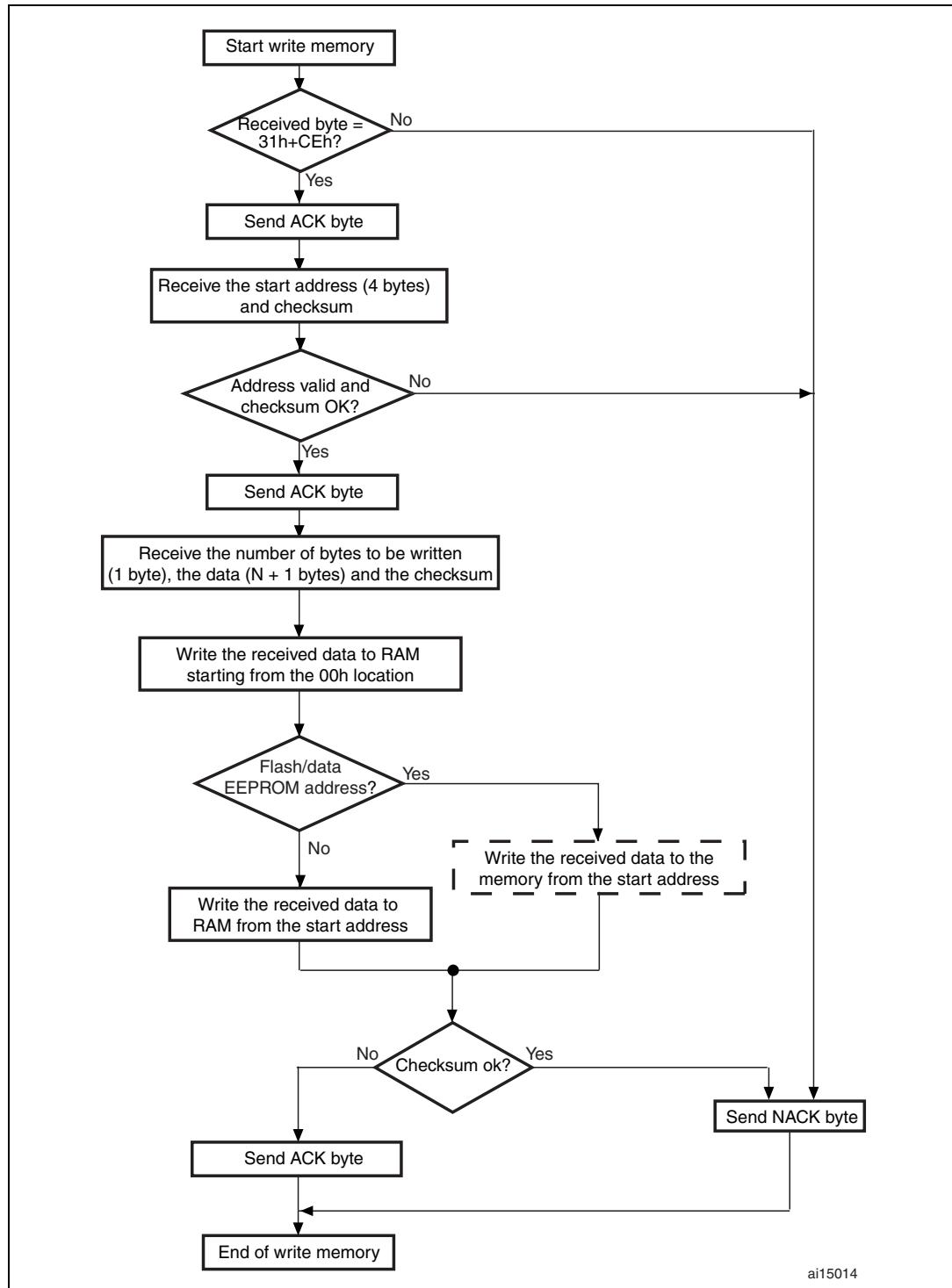

1. 'Write the received data to RAM from the start address' is performed in RAM. The user therefore has to download the write routine in RAM before sending a write command. Note that for some bootloader versions this is not necessary (see 4.8.1: RAM erase/write routines).

### 4.4.2 Write memory command via SPI

Figure 23. Write memory command via SPI - host side

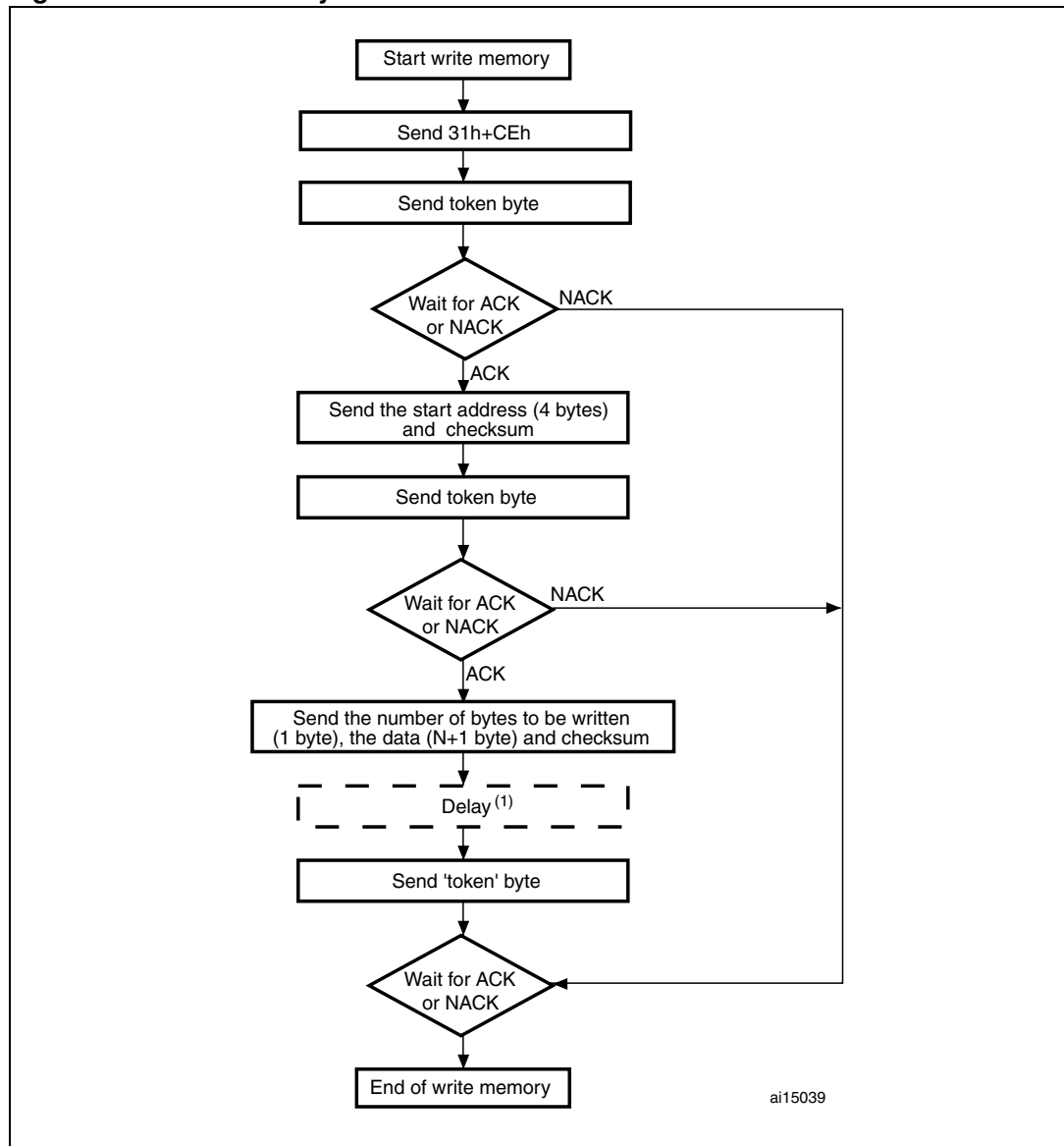

1. Delay or poll "BUSY" flag if device supports it.

The delay is calculated according to [Equation 1](#).

**Equation 1**

$$\text{Delay} = 8.45 \times n[\text{ms}]$$

Where 'n' is the number of write cycles (number of bytes or number of blocks - see [Table 8](#)).

**Table 8. Examples of delay**

Write command	Delay (ms)
128 bytes aligned with a memory block	8.45
128 bytes not aligned with a memory block	1082
1 byte	8.45
10 bytes	84.5

In SPI mode, if the device supports sending a "BUSY" flag during Flash/EEPROM memory programming, the delay can be replaced by polling the device status (a set of token bytes are sent to the device). During programming the device sends the BUSY flag (0xAA) through SPI. When the programming is finished, the device sends an ACK/NACK answer to indicate if the programming was correct or has failed.

Currently, such polling is allowed only for STM8A/S-32K devices with modified RAM routines (see [Appendix C: SPI peripheral timing options](#)). On STM8L-8K and STM8L-64K devices, the BUSY flag is sent through the SPI interface.

**The host sends the bytes as follows**

- Byte 1: 0x31 - Command ID
- Byte 2: 0xCE - Complement
- Byte 3 (token): XY; host waits for ACK or NACK
- Bytes 4 to 7: The start address (32-bit address)
  - Byte 4 = MSB
  - Byte 7 = LSB
- Byte 8: Checksum = XOR (byte 4, byte 5, byte 6, and byte 7)
- Byte 9 (token): XY; host waits for ACK or NACK
- Byte 10: The number of data bytes to be received -1: N = 0 ... 127);  
If N > 127, a cmd\_error occurs in the bootloader.
- N+1 bytes: Max 128 data bytes
- Checksum byte: XOR (N,[N+1 data bytes])
 

**Important:** before sending the token byte, the host must wait for the bootloader to finish writing all data into the memory. See previous delay (or polling) description.
- Last byte (token): 0xXY; host waits for ACK or NACK

Figure 24. Write memory command via SPI - device side

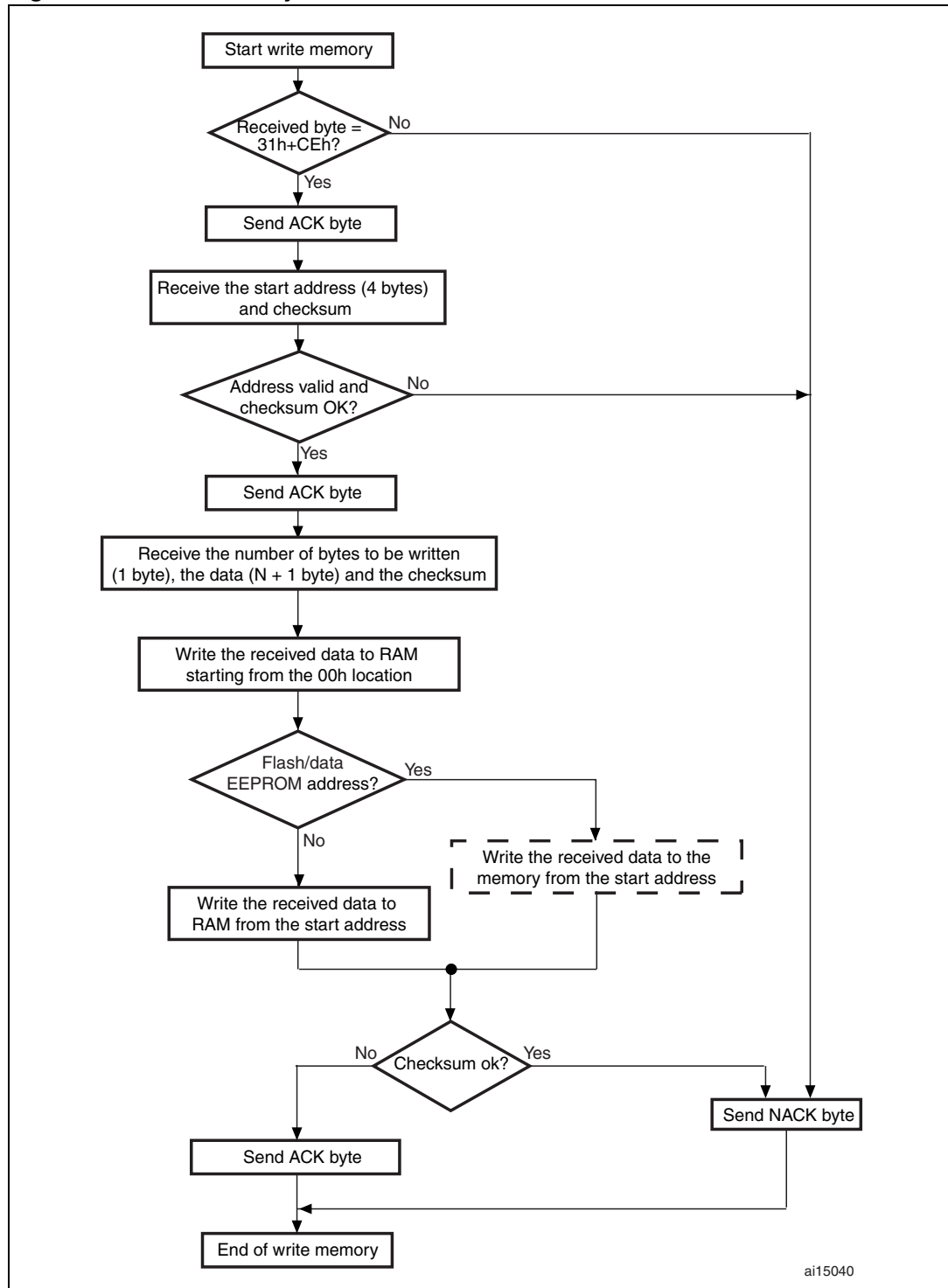

1. 'Write the received data to RAM from the start address' is performed in RAM. The user therefore has to download the write routine in RAM before sending a write command. Note that for some bootloader versions this is not necessary (see 4.8.1: RAM erase/write routines).



### 4.4.3 Write memory command via CAN

Figure 25. Write memory command via CAN - host side

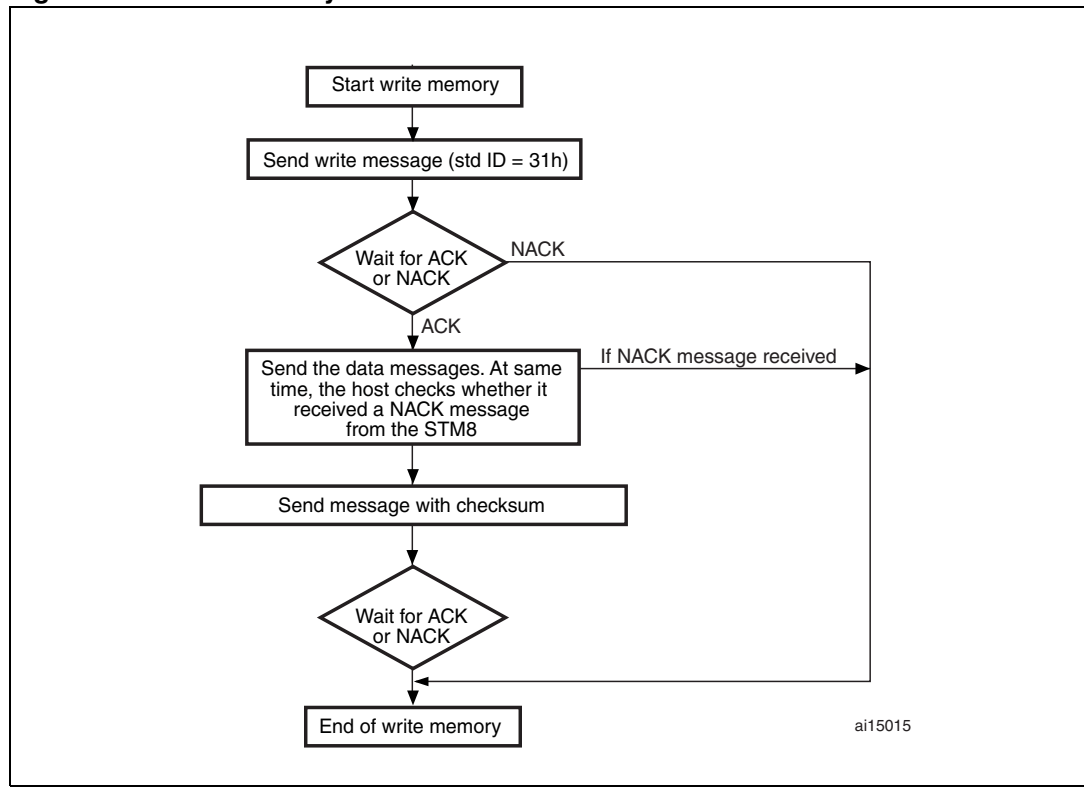

1. See product datasheets for valid addresses. If the bootloader receives an invalid address, an `add_error` occurs (see [Table 10: Error table on page 58](#)).

#### The host sends the messages as follows

Command message: Std ID = 0x31, DLC = 0x05, data = MSB, 0xXX, 0xYY, LSB, N.  
 N = 0 ... 127, number of data bytes -1. If N > 127, a `cmd_error` occurs in the bootloader.

Data message\_1: Std ID = 0x04, DLC\_1 = 1 to 8, data = byte\_11, ... byte\_18

Data message\_2: Std ID = 0x04, DLC\_2 = 1 to 8, data = byte\_21, ... byte\_28

Data message\_3: Std ID = 0x04, DLC\_3 = 1 to 8, data = byte\_31, ... byte\_38

...

Data message\_M: Std ID = 0x04, DLC\_M = 1 to 8, data = byte\_m1, ..., byte\_M8

Checksum message: Std ID = 0x04, DLC = 1, data = XOR (N,[N+1 data bytes])

- Note:
- 1 *DLC\_1 + DLC\_2 + ... DLC\_M = 128 maximum*
  - 2 *The bootloader does not check the standard ID of the data and checksum messages. Therefore, an ID from 0x00 to 0xFF can be used. It is recommended to use 0x04.*

Figure 26. Write memory command via CAN - device side

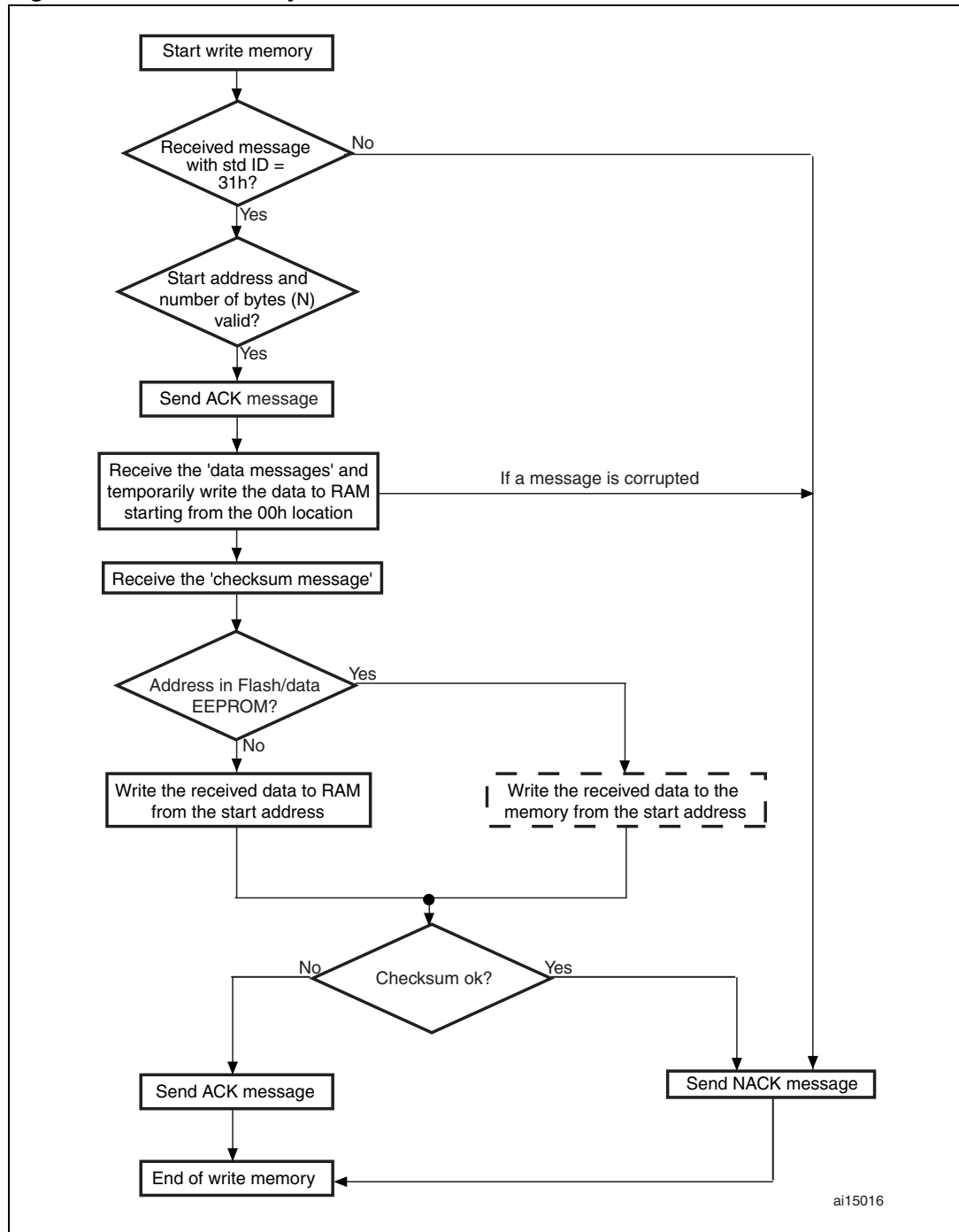

1. Write the received data to the Flash program memory/data EEPROM from the start address' is performed in RAM. The user therefore has to download the write routine in RAM before sending a write command. Note that for some bootloader versions this is not necessary (see 4.8.1: RAM erase/write routines).

## 4.5 Speed command

The speed command allows the baud rate for CAN runtime to be changed. It can be used only if the CAN is the peripheral being used.

### 4.5.1 Speed command via CAN

Figure 27. Speed command via CAN - host side

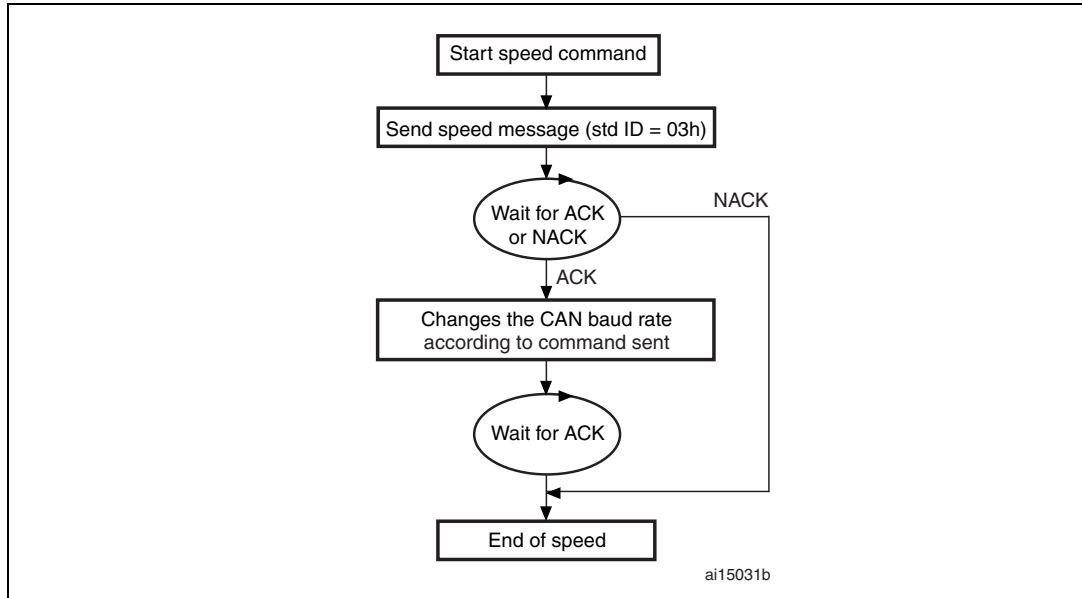

1. After setting the new baud rate, the bootloader sends the ACK message. Therefore, the host sets its baud rate while waiting for the ACK.

#### The host sends the message as follows

Command message: Std ID = 0x03, DLC = 0x01, data = 0xXX where 0xXX assumes the following values depending on the baud rate to be set with HSE:

- 0x01 -> baud rate = 125 kbps
- 0x02 -> baud rate = 250 kbps
- 0x03 -> baud rate = 500 kbps
- 0x04 -> baud rate = 1 Mkbps

Figure 28. Speed command via CAN - device side

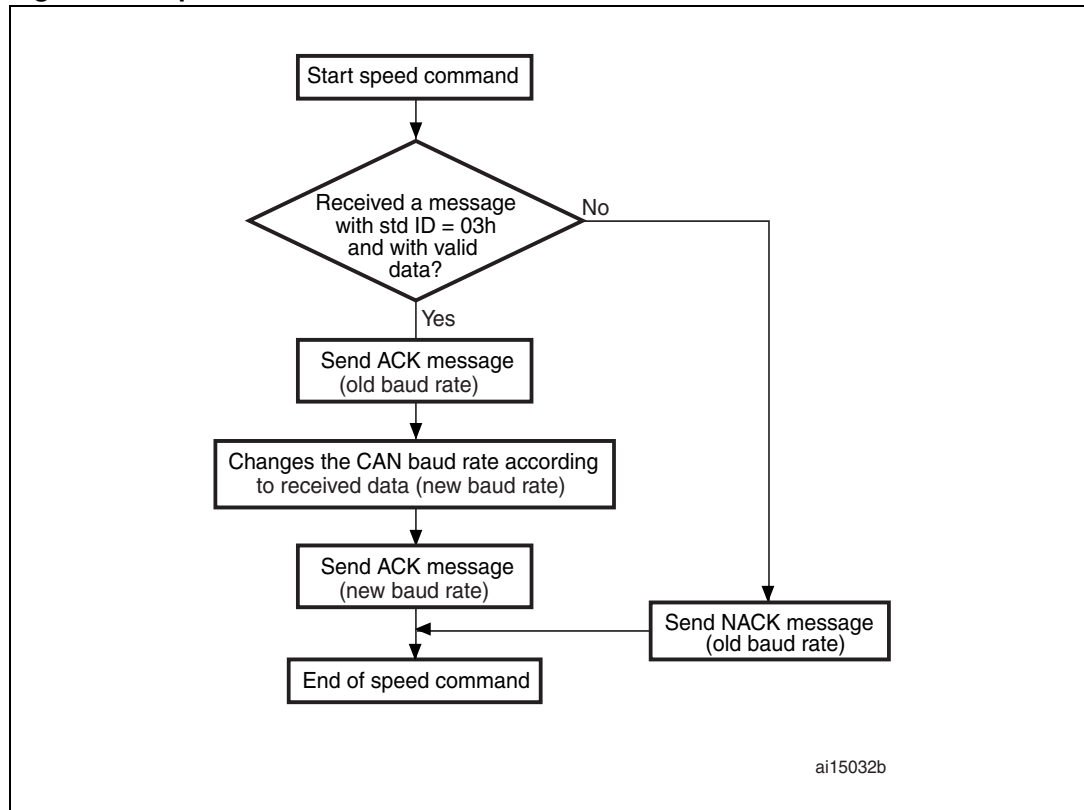

## 4.6 Go command

The go command is used to execute the downloaded code or any other code by branching to an address specified by the host.

### 4.6.1 Go command via USART/LINUART/UART1/UART2/UART3

Figure 29. Go command via USART/LINUART/UART1/UART2/UART3 - host side

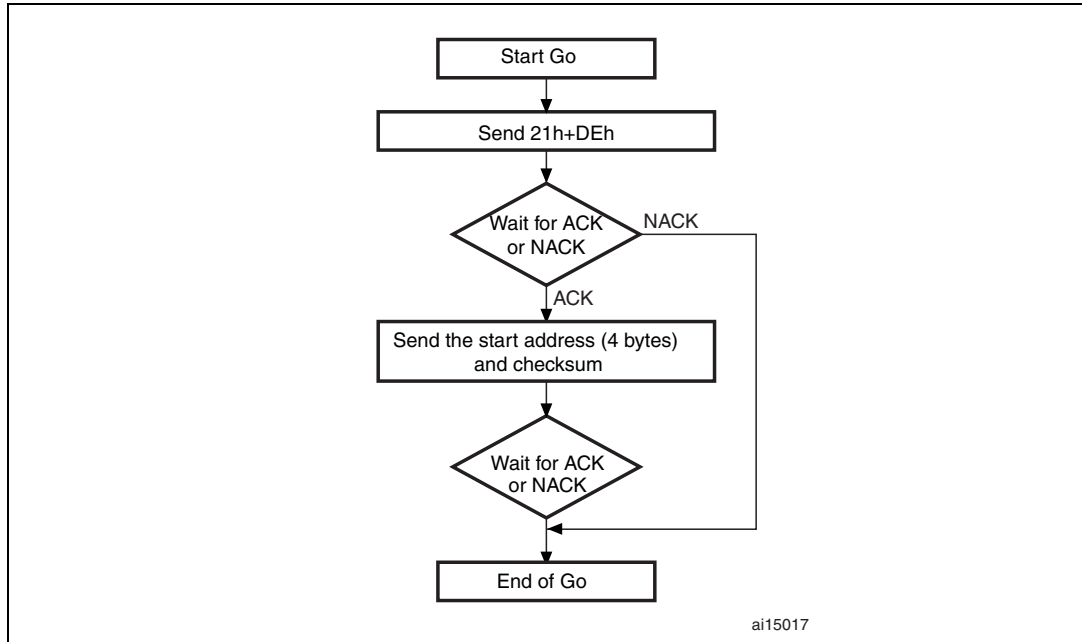

- The valid addresses are RAM, Flash program memory/data EEPROM, and register addresses (see product datasheets). If the bootloader receives an invalid address, an 'add error' occurs (see [Table 10: Error table on page 58](#)).

#### The host sends the bytes as follows

- Byte 1:            0x21     - Command ID
- Byte 2:            0xDE     - Complement
- Bytes 3-6:        The start address (32-bit address)
- Byte 3 = MSB
- Byte 6 = LSB
- Byte 7:            Checksum = XOR (byte 3, byte 4, byte 5, byte 6).

Figure 30. Go command via USART/LINUART/UART1/UART2/UART3 - device side

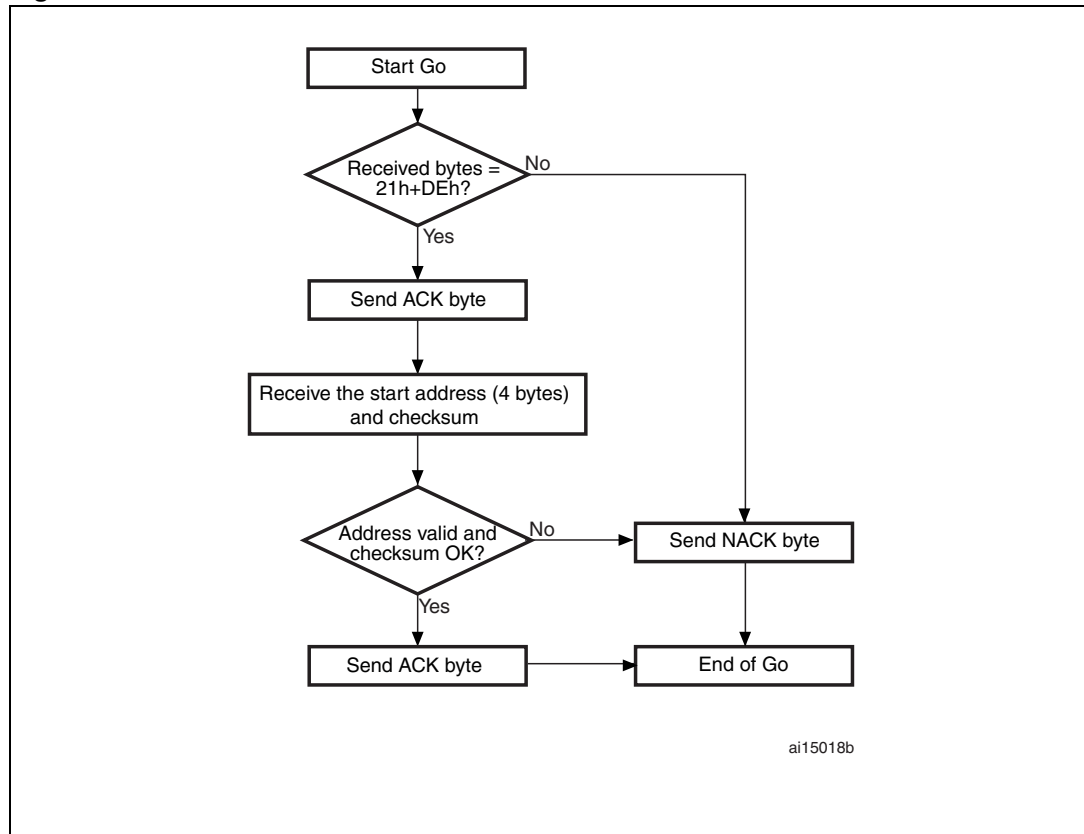

## 4.6.2 Go command via SPI

Figure 31. Go command via SPI - host side

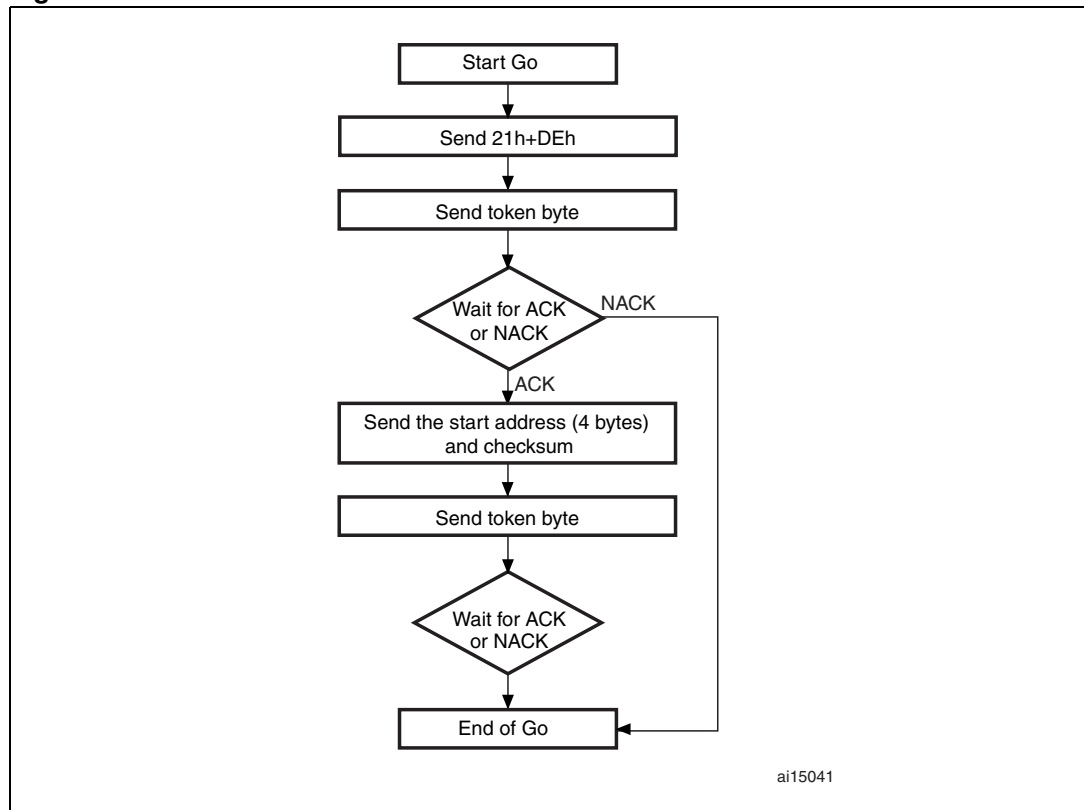

1. The valid addresses are RAM, Flash program memory/data EEPROM and register addresses (see product datasheets). If the bootloader receives an invalid address, an 'add error' occurs (see [Table 10: Error table on page 58](#)).

### The host sends the bytes as follows

- Byte 1:            0x21     - Command ID
- Byte 2:            0xDE     - Complement
- Byte 3 (token):    0xXY; host waits for ACK or NACK
- Bytes 4 to 7:     The start address (32-bit address)
- Byte 4 = MSB
- Byte 7 = LSB
- Byte 8:            Checksum = XOR (byte 4, byte 5, byte 6, and byte 7)
- Byte 9 (token):    0xXY; host waits for ACK or NACK.

Figure 32. Go command via SPI - device side

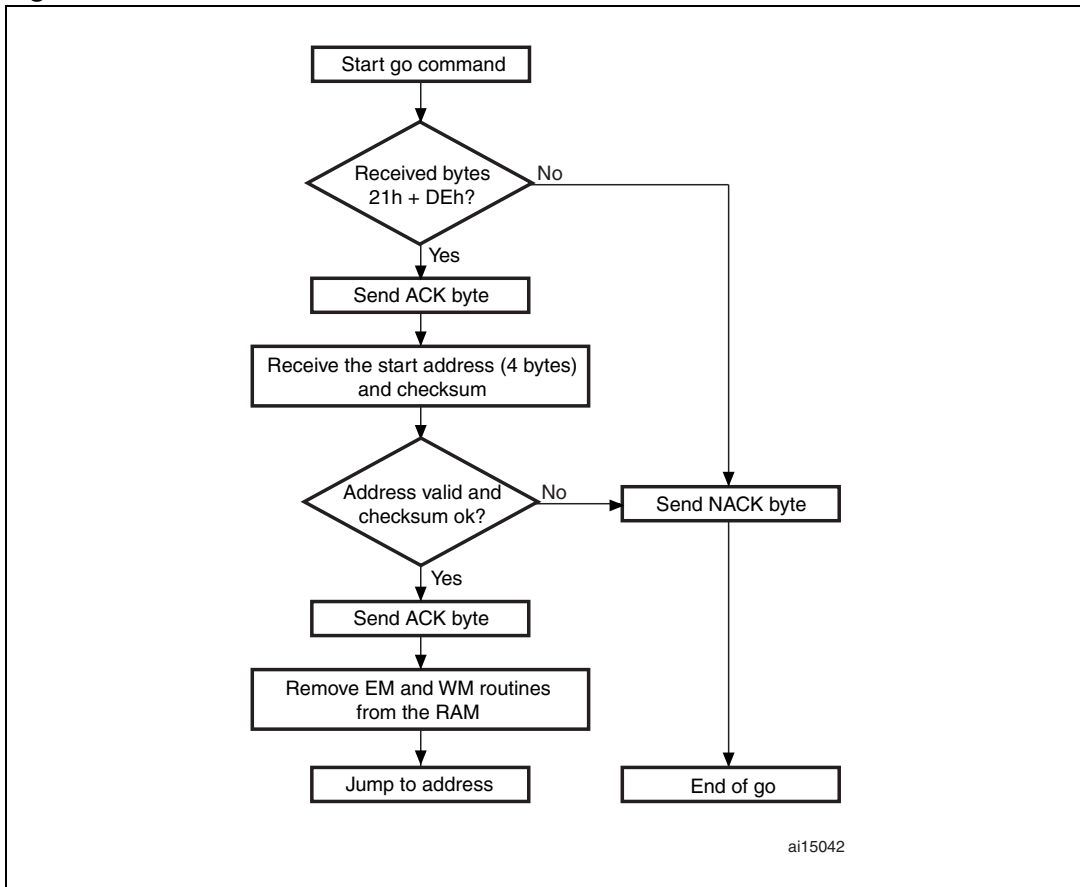



### 4.6.3 Go command via CAN

Figure 33. Go command via CAN - host side

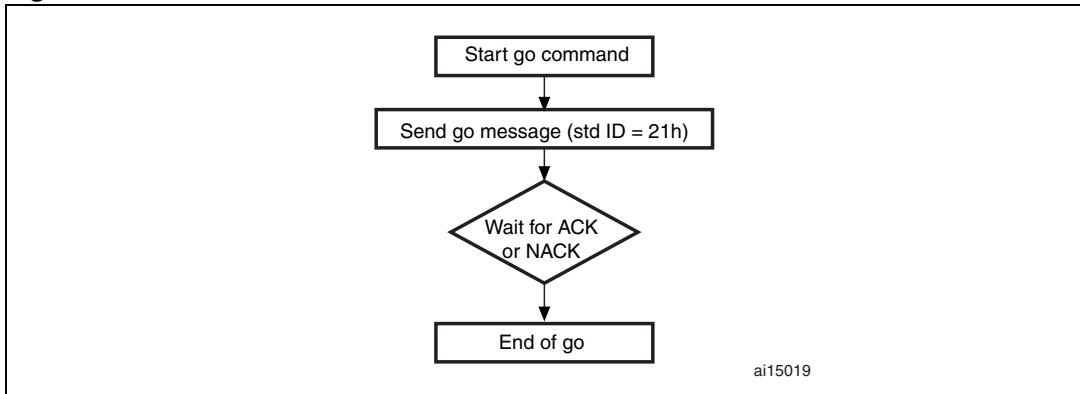

1. See product datasheets for valid addresses.

#### The host sends the bytes as follows

Go command message: Std ID = 0x21, DLC = 0x04, data = MSB, 0xXX, 0xYY, LSB

Figure 34. Go command via CAN - device side

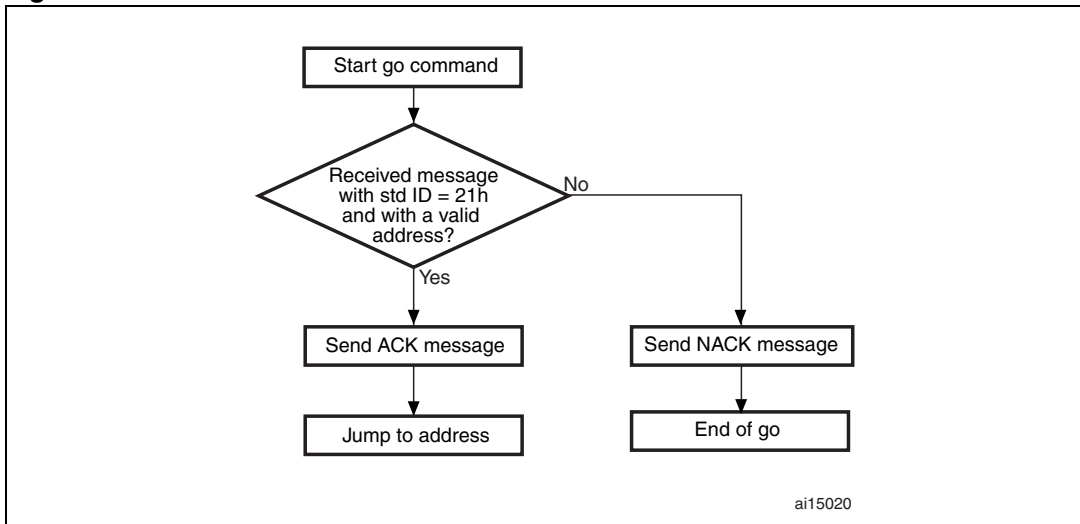

## 4.7 Sector codes

Table 9. STM8 sector codes

Sector code	Flash program memory/data EEPROM				
	STM8A/S-128K	STM8A/S-32K	STM8L-32K	STM8L-64k	STM8L-8k
0x00	0x00 8000 -> 0x00 83FF	0x00 8000 -> 0x00 83FF	0x00 8000 -> 0x00 83FF	0x00 8000 -> 0x00 83FF	0x00 8000 -> 0x00 83FF
0x01	0x00 8400 -> 0x00 87FF	0x00 8400 -> 0x00 87FF	0x00 8400 -> 0x00 87FF	0x00 8400 -> 0x00 87FF	0x00 8400 -> 0x00 87FF
0x02	0x00 8800 -> 0x00 8BFF	0x00 8800 -> 0x00 8BFF	0x00 8800 -> 0x00 8BFF	0x00 8800 -> 0x00 8BFF	0x00 8800 -> 0x00 8BFF
0x03	0x00 8C00 -> 0x00 8FFF	0x00 8C00 -> 0x00 8FFF	0x00 8C00 -> 0x00 8FFF	0x00 8C00 -> 0x00 8FFF	0x00 8C00 -> 0x00 8FFF
0x04	0x00 9000 -> 0x00 93FF	0x00 9000 -> 0x00 93FF	0x00 9000 -> 0x00 93FF	0x00 9000 -> 0x00 93FF	0x00 9000 -> 0x00 93FF
0x05	0x00 9400 -> 0x00 97FF	0x00 9400 -> 0x00 97FF	0x00 9400 -> 0x00 97FF	0x00 9400 -> 0x00 97FF	0x00 9400 -> 0x00 97FF
0x06	0x00 9800 -> 0x00 9BFF	0x00 9800 -> 0x00 9BFF	0x00 9800 -> 0x00 9BFF	0x00 9800 -> 0x00 9BFF	0x00 9800 -> 0x00 9BFF
0x07	0x00 9C00 -> 0x00 9FFF	0x00 9C00 -> 0x00 9FFF	0x00 9C00 -> 0x00 9FFF	0x00 9C00 -> 0x00 9FFF	0x00 9C00 -> 0x00 9FFF
0x08	0x00 A000 -> 0x00 A3FF	0x00 A000 -> 0x00 A3FF	0x00 A000 -> 0x00 A3FF	0x00 A000 -> 0x00 A3FF	0x00 1000 -> 0x00 10FF
0x09	0x00 A400 -> 0x00 A7FF	0x00 A400 -> 0x00 A7FF	0x00 A400 -> 0x00 A7FF	0x00 A400 -> 0x00 A7FF	
0x0A	0x00 A800 -> 0x00 ABFF	0x00 A800 -> 0x00 ABFF	0x00 A800 -> 0x00 ABFF	0x00 A800 -> 0x00 ABFF	
0x0B	0x00 AC00 -> 0x00 AFFF	0x00 AC00 -> 0x00 AFFF	0x00 AC00 -> 0x00 AFFF	0x00 AC00 -> 0x00 AFFF	
0x0C	0x00 B000 -> 0x00 B3FF	0x00 B000 -> 0x00 B3FF	0x00 B000 -> 0x00 B3FF	0x00 B000 -> 0x00 B3FF	
0D	0x00 B400 -> 0x00 B7FF	0x00 B400 -> 0x00 B7FF	0x00 B400 -> 0x00 B7FF	0x00 B400 -> 0x00 B7FF	
0x0E	0x00 B800 -> 0x00 BBFF	0x00 B800 -> 0x00 BBFF	0x00 B800 -> 0x00 BBFF	0x00 B800 -> 0x00 BBFF	
0x0F	0x00 BC00 -> 0x00 BFFF	0x00 BC00 -> 0x00 BFFF	0x00 BC00 -> 0x00 BFFF	0x00 BC00 -> 0x00 BFFF	
0x10	0x00 C000 -> 0x00 C3FF	0x00 C000 -> 0x00 C3FF	0x00 C000 -> 0x00 C3FF	0x00 C000 -> 0x00 C3FF	
0x11	0x00 C400 -> 0x00 C7FF	0x00 C400 -> 0x00 C7FF	0x00 C400 -> 0x00 C7FF	0x00 C400 -> 0x00 C7FF	
0x12	0x00 C800 -> 0x00 CBFF	0x00 C800 -> 0x00 CBFF	0x00 C800 -> 0x00 CBFF	0x00 C800 -> 0x00 CBFF	

Table 9. STM8 sector codes (continued)

Sector code	Flash program memory/data EEPROM				
	STM8A/S-128K	STM8A/S-32K	STM8L-32K	STM8L-64k	STM8L-8k
0x13	0x00 CC00 -> 0x00 CFFF	0x00 CC00 -> 0x00 CFFF	0x00 CC00 -> 0x00 CFFF	0x00 CC00 -> 0x00 CFFF	
0x14	0x00 D000 -> 0x00 D3FF	0x00 D000 -> 0x00 D3FF	0x00 D000 -> 0x00 D3FF	0x00 D000 -> 0x00 D3FF	
0x15	0x00 D400 -> 0x00 D7FF	0x00 D400 -> 0x00 D7FF	0x00 D400 -> 0x00 D7FF	0x00 D400 -> 0x00 D7FF	
0x16	0x00 D800 -> 0x00 DBFF	0x00 D800 -> 0x00 DBFF	0x00 D800 -> 0x00 DBFF	0x00 D800 -> 0x00 DBFF	
0x17	0x00 DC00 -> 0x00 DFFF	0x00 DC00 -> 0x00 DFFF	0x00 DC00 -> 0x00 DFFF	0x00 DC00 -> 0x00 DFFF	
0x18	0x00 E000 -> 0x00 E3FF	0x00 E000 -> 0x00 E3FF	0x00 E000 -> 0x00 E3FF	0x00 E000 -> 0x00 E3FF	
0x19	0x00 E400 -> 0x00 E7FF	0x00 E400 -> 0x00 E7FF	0x00 E400 -> 0x00 E7FF	0x00 E400 -> 0x00 E7FF	
0x1A	0x00 E800 -> 0x00 EBFF	0x00 E800 -> 0x00 EBFF	0x00 E800 -> 0x00 EBFF	0x00 E800 -> 0x00 EBFF	
0x1B	0x00 EC00 -> 0x00 EFFF	0x00 EC00 -> 0x00 EFFF	0x00 EC00 -> 0x00 EFFF	0x00 EC00 -> 0x00 EFFF	
0x1C	0x00 F000 -> 0x00 F3FF	0x00 F000 -> 0x00 F3FF	0x00 F000 -> 0x00 F3FF	0x00 F000 -> 0x00 F3FF	
0x1D	0x00 F400 -> 0x00 F7FF	0x00 F400 -> 0x00 F7FF	0x00 F400 -> 0x00 F7FF	0x00 F400 -> 0x00 F7FF	
0x1E	0x00 F800 -> 0x00 FBFF	0x00 F800 -> 0x00 FBFF	0x00 F800 -> 0x00 FBFF	0x00 F800 -> 0x00 FBFF	
0x1F	0x00 FC00 -> 0x00 FFFF	0x00 FC00 -> 0x00 FFFF	0x00 FC00 -> 0x00 FFFF	0x00 FC00 -> 0x00 FFFF	
0x20	0x01 0000 -> 0x01 03FF	0x00 4000 -> 0x00 43FF	0x00 1000 -> 0x00 13FF	0x01 0000 -> 0x01 03FF	
0x21	0x01 0400 -> 0x1 07FF			0x01 0400 -> 0x1 07FF	
0x22	0x01 0800 -> 0x01 0BFF			0x01 0800 -> 0x01 0BFF	
0x23	0x01 0C00 -> 0x01 0FFF			0x01 0C00 -> 0x01 0FFF	
0x24	0x01 1000 -> 0x01 13FF			0x01 1000 -> 0x01 13FF	
0x25	0x01 1400 -> 0x01 17FF			0x01 1400 -> 0x01 17FF	
0x26	0x01 1800 -> 0x01 1BFF			0x01 1800 -> 0x01 1BFF	

Table 9. STM8 sector codes (continued)

Sector code	Flash program memory/data EEPROM				
	STM8A/S-128K	STM8A/S-32K	STM8L-32K	STM8L-64k	STM8L-8k
0x27	0x01 1C00 -> 0x01 1FFF			0x01 1C00 -> 0x01 1FFF	
0x28	0x01 2000 -> 0x01 23FF			0x01 2000 -> 0x01 23FF	
0x29	0x01 2400 -> 0x01 27FF			0x01 2400 -> 0x01 27FF	
0x2A	0x01 2800 -> 0x01 2BFF			0x01 2800 -> 0x01 2BFF	
0x2B	0x01 2C00 -> 0x01 2FFF			0x01 2C00 -> 0x01 2FFF	
0x2C	0x01 3000 -> 0x01 33FF			0x01 3000 -> 0x01 33FF	
0x2D	0x01 3400 -> 0x01 37FF			0x01 3400 -> 0x01 37FF	
0x2E	0x01 3800 -> 0x01 3BFF			0x01 3800 -> 0x01 3BFF	
0x2F	0x01 3C00 -> 0x01 3FFF			0x01 3C00 -> 0x01 3FFF	
0x30	0x01 4000 -> 0x01 43FF			0x01 4000 -> 0x01 43FF	
0x31	0x01 4400 -> 0x01 47FF			0x01 4400 -> 0x01 47FF	
0x32	0x01 4800 -> 0x01 4BFF			0x01 4800 -> 0x01 4BFF	
0x33	0x01 4C00 -> 0x01 4FFF			0x01 4C00 -> 0x01 4FFF	
0x34	0x01 1000 -> 0x01 53FF			0x01 1000 -> 0x01 53FF	
0x35	0x01 5400 -> 0x01 57FF			0x01 5400 -> 0x01 57FF	
0x36	0x01 5800 -> 0x01 5BFF			0x01 5800 -> 0x01 5BFF	
0x37	0x01 5C00 -> 0x01 5FFF			0x01 5C00 -> 0x01 5FFF	
0x38	0x01 6000 -> 0x01 63FF			0x01 6000 -> 0x01 63FF	
0x39	0x01 6400 -> 0x01 67FF			0x01 6400 -> 0x01 67FF	
0x3A	0x01 6800 -> 0x01 6BFF			0x01 6800 -> 0x01 6BFF	

Table 9. STM8 sector codes (continued)

Sector code	Flash program memory/data EEPROM				
	STM8A/S-128K	STM8A/S-32K	STM8L-32K	STM8L-64k	STM8L-8k
0x3B	0x01 6C00 -> 0x01 6FFF			0x01 6C00 -> 0x01 6FFF	
0x3C	0x01 7000 -> 0x01 73FF			0x01 7000 -> 0x01 73FF	
0x3D	0x01 7400 -> 0x01 77FF			0x01 7400 -> 0x01 77FF	
0x3E	0x01 7800 -> 0x01 7BFF			0x01 7800 -> 0x01 7BFF	
0x3F	0x01 7C00 -> 0x01 7FFF			0x01 7C00 -> 0x01 7FFF	
0x40	0x01 8000 -> 0x01 83FF			0x00 1000 -> 0x00 13FF	
0x41	0x01 8400 -> 0x01 87FF			0x00 1400 -> 0x00 17FF	
0x42	0x01 8800 -> 0x01 8BFF				
0x43	0x01 8C00 -> 0x01 8FFF				
0x44	0x01 9000 -> 0x01 93FF				
0x45	0x01 9400 -> 0x01 97FF				
0x46	0x01 9800 -> 0x01 9BFF				
0x47	0x01 9C00 -> 0x01 9FFF				
0x48	0x01 A000 -> 0x01 A3FF				
0x49	0x01 A400 -> 0x01 A7FF				
0x4A	0x01 A800 -> 0x01 ABFF				
0x4B	0x01 AC00 -> 0x01 AFFF				
0x4C	0x01 B000 -> 0x01 B3FF				
0x4D	0x01 B400 -> 0x01 B7FF				
0x4E	0x01 B800 -> 0x01 BBFF				

Table 9. STM8 sector codes (continued)

Sector code	Flash program memory/data EEPROM				
	STM8A/S-128K	STM8A/S-32K	STM8L-32K	STM8L-64k	STM8L-8k
0x4F	0x01 BC00 -> 0x01 BFFF				
0x50	0x01 C000 -> 0x01 C3FF				
0x51	0x01 C400 -> 0x01 C7FF				
0x52	0x01 C800 -> 0x01 CBFF				
0x53	0x01 CC00 -> 0x01 CFFF				
0x54	0x01 D000 -> 0x01 D3FF				
0x55	0x01 D400 -> 0x01 D7FF				
0x56	0x01 D800 -> 0x01 DBFF				
0x57	0x01 DC00 -> 0x01 DFFF				
0x58	0x01 E000 -> 0x01 E3FF				
0x59	0x01 E400 -> 0x01 E7FF				
0x5A	0x01 E800 -> 0x01 EBFF				
0x5B	0x01 EC00 -> 0x01 EFFF				
0x5C	0x01 F000 -> 0x01 F3FF				
0x5D	0x01 F400 -> 0x01 F7FF				
0x5E	0x10 F800 -> 0x10 FBFF				
0x5F	0x10 FC00 -> 0x10 FFFF				
0x60	0x20 0000 -> 0x20 03FF				
0x61	0x20 0400 -> 0x20 07FF				
0x62	0x02 0800 -> 0x02 0BFF				

Table 9. STM8 sector codes (continued)

Sector code	Flash program memory/data EEPROM				
	STM8A/S-128K	STM8A/S-32K	STM8L-32K	STM8L-64k	STM8L-8k
0x63	0x02 0C00 -> 0x02 0FFF				
0x64	0x02 1000 -> 0x02 13FF				
0x65	0x02 1400 -> 0x02 17FF				
0x66	0x02 1800 -> 0x02 1BFF				
0x67	0x02 1C00 -> 0x02 1FFF				
0x68	0x02 2000 -> 0x02 23FF				
0x69	0x02 2400 -> 0x02 27FF				
0x6A	0x02 2800 -> 0x02 2BFF				
0x6B	0x02 2C00 -> 0x02 2FFF				
0x6C	0x02 2000 -> 0x02 23FF				
0x6D	0x02 2400 -> 0x02 27FF				
0x6E	0x02 3800 -> 0x02 3BFF				
0x6F	0x02 3C00 -> 0x02 3FFF				
0x70	0x02 4000 -> 0x02 43FF				
0x71	0x02 4400 -> 0x02 47FF				
0x72	0x02 4800 -> 0x02 4BFF				
0x73	0x02 4C00 -> 0x02 4FFF				
0x74	0x02 5000 -> 0x02 53FF				
0x75	0x02 5400 -> 0x02 57FF				
0x76	0x02 5800 -> 0x02 5BFF				

**Table 9. STM8 sector codes (continued)**

Sector code	Flash program memory/data EEPROM				
	STM8A/S-128K	STM8A/S-32K	STM8L-32K	STM8L-64k	STM8L-8k
0x77	0x02 5C00 -> 0x02 5FFF				
0x78	0x02 6000 -> 0x02 63FF				
0x79	0x02 6400 -> 0x02 67FF				
0x7A	0x0 26800 -> 0x0 26BFF				
0x7B	0x02 6C00 -> 0x0 26FFF				
0x7C	0x02 7000 -> 0x02 73FF				
0x7D	0x02 7400 -> 0x02 77FF				
0x7E	0x02 7800 -> 0x02 7BFF				
0x7F	0x02 7C00 -> 0x02 7FFF				
0x80	0x00 4000 -> 0x00 43FF				
0x81	0x00 4400 -> 0x00 47FF				

### 4.8 Software model (STM8A/L/S)

The boot code has been designed with the same logical protocol for exchanging command frames between host and any STM8L/S device.

The boot code can download up to 128 bytes at a time. Bootloader variables occupy the RAM from address 0x00 0000 up to address 0x00 009F.

If the bootloader is enabled (according to [Table 4](#)) and timeouts have elapsed (there is no host activation or jump to the user application), the RAM content can be modified by the bootloader. For example, if the user application is running and a reset occurs, the RAM content in a given range is changed by the bootloader before the application restarts.

If the bootloader is disabled by using an option byte or ROP protection, the following minor modifications of the user application are needed:

- STM8L devices and latest STM8A/S bootloader versions (see [Table 3](#)): the RAM is not modified
- STM8A/S devices with older bootloader versions: only the content RAM address, 0x00 0099, is changed to 0x01.

*Note:* Unused (empty) bootloader ROM is filled with an opcode that is not allowed (0x71). If, for any reason (i.e. EMC noise), the core starts to execute in the 0x71 area, an illegal opcode is



*returned and consequently a reset. This prevents the bootloader falling into an infinite loop with no reset in the event that it jumps in the 'empty' locations. Thus normal execution can resume.*

#### 4.8.1 RAM erase/write routines

RAM erase/write routines are attached to this document as binary code files in S19 format. The file name defines the STM8 group (e.g. 128 Kbytes, 32 Kbytes, 8 Kbytes) and bootloader version number for which the given routine is written.

To erase or program the Flash program memory or data EEPROM, the respective routines must be downloaded into RAM starting at 0x00 00A0.

RAM erase/write routine naming example:

- STM8A/S 128-Kbyte devices: E\_W\_ROUTINEs\_128K\_ver\_2.2.s19
- STM8A/S 32-Kbyte devices: E\_W\_ROUTINEs\_32K\_ver\_1.3.s19
- STM8L devices: no need to download RAM routines - the routines are copied into RAM from ROM automatically when the bootloader is activated by the host (after it has received a valid SYNCH byte)

*Note: To execute any of the commands (get, read, erase, write, speed, and go), the bootloader uses part of the RAM for its own variables and RAM erase/write routines. Therefore, it is forbidden to run write commands (with the exception of write commands that are used for downloading erase/write routines) with destination addresses in the following RAM locations:*

- STM8A/S devices: 0x00 0000 to 0x00 01FF
- STM8L devices: 0x00 0000 to 0x00 01FF

## 5 Error management

The bootloader performs more internal checks including valid address range in commands, commands checksum, and write verification. The bootloader does not check the UBC area access. If a write is performed to a write-protected area, the verification fails and the bootloader returns a NACK.

[Table 10](#) describes the error type and the bootloader behavior.

**Table 10. Error table**

Error	Description	Bootloader actions
cmd_error	If a denied command is received If a parity error occurs during command transmission If an error occurs during the command execution See <a href="#">Table 6: Bootloader commands on page 14</a>	Sends NACK byte and goes back to command checking
add_error	If a received command contains a denied destination address. For information on valid address ranges, see the product datasheets for STM8A/L/S devices.	Sends NACK byte and goes back to command checking

## 6 Programming time

The programming time depends on the baud rate speed of the peripheral. Programming time examples measured on the following interfaces and speeds include:

- USART/LINUART/UART1/UART2/UART3: 128 kbps, 256 kbps, and 500 kbps
- SPI: 125 kbps, 250 kbps, 500 kbps, and 1 Mbps
- CAN: 125 kbps, 250 kbps, 500 kbps, and 1 Mbps

*Note:* Measurements were performed on 48 Kbyte or 32 Kbyte blocks independent of the device type and peripheral used.

Table 11, Table 12, and Table 13 show the programming times for the USART/LINUART/UART1/UART2/UART3, SPI, and CAN respectively.

**Table 11. USART/LINUART/UART1/UART2/UART3 programming times**

Time to load Kbytes/block/bytes in the Flash program memory	Baud rate (bps)		
	128000	256000	500000
48 Kbytes	7.73 s	5.34 s	4.08 s
1 block	20.13 ms	13.53 ms	10.65 ms
1 byte	7.52 ms	6.93 ms	6.65 ms

**Table 12. SPI programming time**

Time to load Kbytes/block/bytes in the Flash program memory	Baud rate			
	125 kbps	250 kbps	500 kbps	1 Mbps
32 Kbytes	4.46 s	3.34 s	2.81 s	2.55 s
1 block	17.44 ms	13.04 ms	11.01 ms	9.95 ms
1 byte	8.52 ms	8.12 ms	7.93 ms	7.84 ms

**Table 13. CAN programming time**

Time to load Kbytes/block/bytes in the Flash program memory	Baud rate			
	125 kbps	250 kbps	500 kbps	1 Mbps
48 Kbytes	9.50 s	6.40 s	4.85 s	4.07 s
1 block	24.73 ms	16.66 ms	12.63 ms	10.60 ms
1 byte	9.23 ms	8.53 ms	7.91 ms	7.68 ms

## Appendix A How to upload ROP protected device

The readout protection (ROP) feature prevents the device memory content being read through the SWIM interface. During its initialization the bootloader checks the ROP state (by checking the ROP option byte) and if it is enabled the bootloader is not activated. This prevents the memory content being read through the bootloader (or a Trojan horse being written and executed).

However, in practice, the user may need to have the ROP protection enabled and still be able to upload new firmware through IAP (in-application programming). This can be done via a user application and bootloader interaction, subject to the following rules.

### A.1 Rules for upgrading ROP protected devices

1. The device must be ROP protected (to disable reading through the SWIM).
2. The bootloader is not activated after reset due to the check on the ROP state (to disable reading through the bootloader).
3. The user application is responsible for enabling a device update after user authentication, for example, after a user password check.
4. The user application then allows the authenticated user to invoke the bootloader (by jumping to a bootloader specific address). The bootloader can then update the user application in the normal way.

Following the above rules, the user application can be updated by the resident ROM bootloader. The only condition is that the user application must interact with the upload process as outlined below:

- The application must implement an authentication procedure (for example by sending an authentication command with a password through the communication interface).
- The application must jump to the “ROP check” in which the bootloader entry point is checked. See [Table 14: Bootloader entry points](#) for the addresses of the principle bootloader entry points.

## Appendix B Bootloader entry points

The ROM bootloader can be activated by the host after device reset. However the bootloader can also be used by the user application for various purposes.

In [Table 14](#) lists the main bootloader entry points and describes how they can be used by the user application.

**Table 14. Bootloader entry points**

Entry point name	Address and bootloader version <sup>(1)</sup>				Entry point name	Usages
	STM8A/S-128K	STM8A/S-32K	STM8L-32K	STM8L-64K		
Reset	0x00 6000	0x00 6000	0x00 6000	0x00 6000	0x00 6000	Bootloader starts here - It can be used to perform a hard reset
BL option check	0x00 601E (v2.1) <sup>(2)</sup> 0x00 601E (v2.2)	0x00 601E (v1.2) 0x00 6018 (v1.3)	0x00 601A (v1.1) 0x00 601F (v1.2)	0x00 601F (v1.1)	0x00 601F (v1.0)	Point after checking if bootloader is enabled by option byte. It can be used to jump to the bootloader which was disabled by the option bytes.
ROP check	0x00 602E (v2.1) 0x00 602E (v2.2)	0x00 602E (v1.2) 0x00 6028 (v1.3)	0x00 6028 (v1.1) 0x00 602D (v1.2) <sup>(3)</sup>	0x00 602D (v1.1)	0x00 602D (v1.0)	Point after checking the readout protection. It can be used to jump to the bootloader - if ROP is active - for upgrading an ROP-protected device after master user authentication.

1. The address depends on the bootloader version and may be changed in the next bootloader version. Contact your local STMicroelectronics office for the latest information.
2. The RAM variable at address 0x00 0099 should be set to the value 0x00 or 0x01 for this bootloader version (0x00 = no timeout, 0x01 = 1 second bootloader timeout).
3. No ROP check entry point is defined for bootloader version 1.0.

## Appendix C SPI peripheral timing options

### C.1 SPI with busy state checking

Sections [4.3.2: Erase memory command via SPI](#) and [4.4.2: Write memory command via SPI](#) contain flowcharts for the SPI erase and write commands. A disadvantage of the SPI interface is that it is driven by the host which controls the transfers by polling the data from the device. If the device is busy (for example, if it is programming the Flash memory), the device answers by writing the last byte in the SPI data register (which is the last sent byte from the previous polling). So the host has no way of knowing if the received byte is the correct (new) answer or the byte from the previous answer.

In practice, if the host asks the device to complete an ongoing erase or write command (ACK or NACK from the device after the operation is finished), it knows that the device is not busy and has finished operations. So the host must add an appropriate minimum delay to allow the device to finish an operation (see the “Delay” box in [Figure 17](#) and [Figure 23](#). Otherwise, the answer is meaningless and communication is desynchronized.

This behavior is specific only to host driven interfaces such as the SPI. Other interfaces used by the bootloader, including the UART and CAN, are not master driven (and the device can answer without host polling).

### C.2 Modified erase/write RAM routines

To remove dependency from delay implementations on the host side and to speed up SPI communication (because delays with a margin are longer), **special erase/write RAM routines** have been developed. These RAM routines perform long-time operations such as standard erase/write operations. During device busy state, they send a “BUSY” byte (0xAA) answer to the host. The host can then periodically ask the device for an answer and the device sends a “BUSY” answer until the operation is finished. When the operation is finished, the device answers with an ACK or NACK according to the operation result. At this point, the “Delay” box in [Figure 17](#) and [Figure 23](#) is replaced with a polling loop until the ACK or NACK answer is received.

Modified erase/write RAM routines for SPI polling support are provided with STM8A/S 32-Kbyte devices. STM8L devices natively support RAM routines with a BUSY status reply.

Figure 35. Delay elimination in modified RAM routines

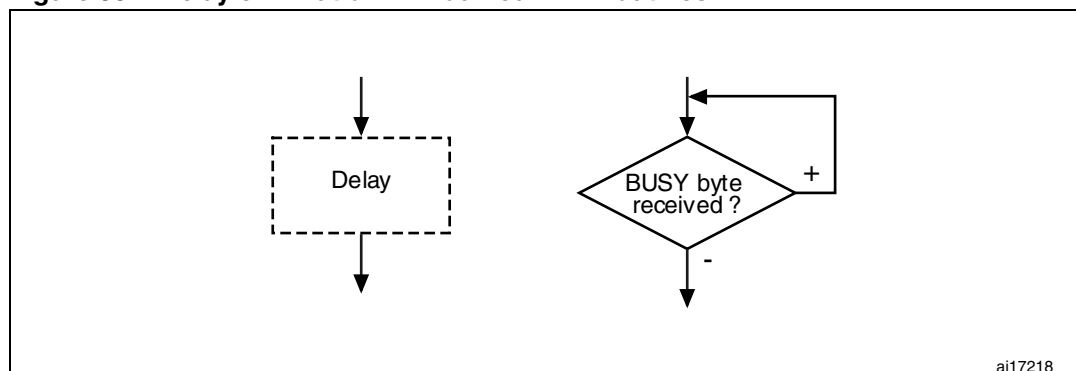

## Appendix D PC software support

To support the bootloader, STMicroelectronics provides a PC demo application known as *"Flash loader demonstrator"* which allows the user to upload firmware into the STM8 device through the UART interface (RS232 on PC side). The software runs under Microsoft® Windows® and can be downloaded from [www.st.com](http://www.st.com).

With this software, any firmware stored in an *"\*.s19"* file can be uploaded to an STM8A/L/S device. It also performs verification of the uploaded firmware and automatic erasing.

**Figure 36. "Flash loader demonstrator" software**

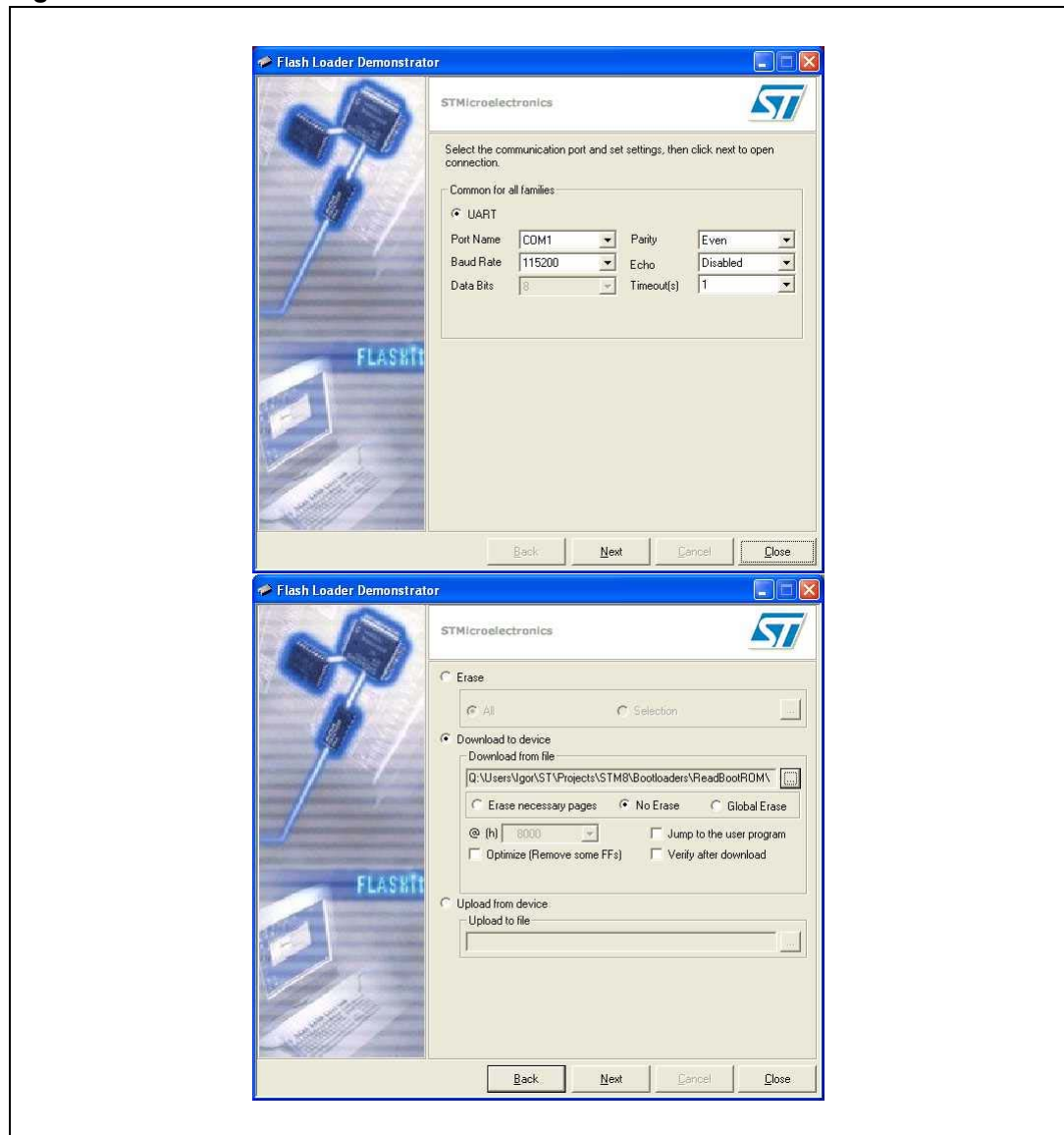

## Appendix E Bootloader UART limitation

### E.1 Description

The bootloader limitation is not caused by a wrong bootloader implementation, or a non-compliance with specifications, but results from customer specific usage of the STM8 ROM bootloader.

To prevent future problems for occurring, use the workarounds that apply to your specific case (see [Section E.2: Workaround for UART limitation](#)).

#### E.1.1 UART automatic baudrate calculation

As explained in [Section 3.1: USART/UARTs settings](#), the bootloader polls all peripherals (CAN, SPI, UART, SPI) waiting for a synchronization byte. The communications start when a synchronization byte equal to 0x7F has been received.

For UART communications, the baudrate at which UART data transfers are performed by the master is unknown whereas it is preknown for SPI communications, and fixed to 125 kbps for CAN.

Before initializing the UART interface, the bootloader waits for the 0x7F byte, and deduces the master baudrate from the speed at which the synchronization byte is sent. This is called the automatic baudrate mechanism. This is done by polling the RxD GPIO pin.

1. The master sends 0x7F in serial format (LSB first) through the UART interface. 0x7F is composed of:
  - Start bit ('0')
  - 7 consecutive logical 1s bits (LSB first)
  - 1 logical '0' (MSB bit of 0x7F)
  - Even parity bit ('1')
  - Stop bit ('1')
2. The bootloader polls the RxD pin and waits for the start bit ('0').
3. The bootloader starts the timer just after a rising edge has been detected on RxD (LSB bit) and measures the duration of the 7 logical 1s transmission.
4. The bootloader stops the timer when a falling edge is detected on RxD (end of 7 consecutive logical 1s – beginning of MSB). The number of timer ticks represents the duration the 7 logical 1s. The bootloader deduces the time required to transmit one bit by dividing the timer ticks by 7, calculates the baudrate, and initializes the UART baudrate accordingly. The bootloader is then ready to receive the next command from the master.

#### E.1.2 Description of UART limitation

Automatic baudrate calculation assumes that the master sends 0x7F as synchronization byte. However, the calculated baudrate is incorrect if the master sends a value different from 0x7F. This is due to fact that the bootloader expects 7 consecutive logical 1s after the start bit.

As an example, if the master sends 0x78 as synchronization byte, the start bit is followed by 4 consecutive logical 1s. Since the bootloader expects 7 consecutive 1s, the baudrate computed by the bootloader is 7/4 of the master baudrate. The next communication



between master and bootloader fails due to indifferent baudrates, and the bootloader enters an endless loop waiting for valid master command. This state can only be exited by resetting the STM8 device.

The master must consequently send 0x7F after reset to launch the bootloader correctly or must sent nothing during 1 second after reset to avoid launching the bootloader and continue executing the user application. Any another byte sent to the bootloader up to 1 second after reset causes the bootloader to enter an endless loop.

This situation may occur in user application if the STM8 device is reset and huge data transfers are in progress through the UART interface. The device then enters an endless loop due to several synchronization byte reception.

## E.2 Workaround for UART limitation

The issue described above can be fixed by using the workaround below.

This workaround consists in modifying your application code and the device configuration. It is recommended if your application is subject to enter an endless loop when starting UART communications. The following steps are required:

1. Disable the bootloader by using the option bytes (disabled on virgin devices).
2. Insert in your application code a routine that invokes the bootloader when a firmware upgrade is required, e.g. your code jumps to given bootloader entry point after pressing a button (see [Appendix B: Bootloader entry points](#) for details on entry point addresses).

As a result the bootloader is not active after reset and will not enter an endless loop when receiving random UART bytes. After reset the bootloader executes the application code without any delay, which is also a benefit for your application.

If an upgrade of the application code is required, follow the sequence below:

1. Press the button so that the code invokes the bootloader and jumps to a given bootloader entry point. You must make sure that a master device is connected to the UART interface and no random byte is sent.
2. Run the master to upgrade the code through the standard ROM bootloader.
3. Reset the device when the upgrade is complete.

Invoking the bootloader by pressing a button can be replaced by any similar action, e.g. receiving a specific command or an authentication password to launch an upgrade of the application code (only authenticated person can upgrade).

The programming operation might crash during code upgrade (for example when powering off the device). In this case, the bootloader cannot be entered again because the application code was not properly upgraded and is invalid. To prevent this issue from occurring, it is recommended that the master executes the following steps before entering the bootloader:

1. Enable the ROM bootloader through the option bytes before downloading the application code into device.
2. Download the application code and verify it.
3. Disable again the ROM bootloader by using the option bytes.

## Appendix F Limitations and improvements versus bootloader versions

A given STM8 group is associated with a specific bootloader code. This code has been improved during the device life and new bootloader versions have been implemented. The differences between bootloader versions are summarized in [Table 15](#), together with the limitations, improvements, and added features for a given bootloader version.

**Table 15. Description of limitation, improvements and added features**

STM8 group	Bootloader version	Device revision	Limitations, improvements, and added features
STM8S/A-128K	2.1	Rev X	Initial version Limitations: – CPU clock is set to HSI/1 (16 MHz) when bootloader resumes – CAN interface does not work correctly. Contact your nearest STMicroelectronics sales office for the CAN workaround that can be implemented on this bootloader version.
	2.2	Rev U and T: STM8AFxxxx52xx, STM8AF6269/8x/Ax Rev Y, 6, W, 7: STM8S207/208xx	Improvement: – EMC lockup protection Fixed limitations: – CPU clock is set back to its reset state when bootloader resumes – CAN peripheral works correctly
STM8S/A-32K	1.2	Rev Y: STM8AF612x/4x, STM8AF6166/68 Rev Z: STM8S105xx	Initial version Limitations: – Some peripheral registers are not set back to their reset value when jumping to user application after a 1 second timeout.
	1.3	Rev X, W: STM8AF622x/4x, STM8AF6266/68 Rev Y, 6, X, 7: STM8S105xx	Improvements: – EMC lockup protection – All registers are set back to their reset values when bootloader resumes Feature added: – SPI peripheral uses BUSY flag (see <a href="#">Appendix C: SPI peripheral timing options</a> )
STM8L-64K	1.0	Rev A	Initial version Improvement: – EMC lockup protection Limitation: – Bootloader clock disabled when bootloader resumes
	1.1	Rev Z	Fixed limitations: – Bootloader clock not disabled when bootloader resumes

Table 15. Description of limitation, improvements and added features (continued)

STM8 group	Bootloader version	Device revision	Limitations, improvements, and added features
STM8L-32K	1.0	Rev A	Initial version Limitations: – Readout protection option bit (ROP) not checked – CPU clock is set to HSI/1 (16 MHz) when bootloader resumes – Timeout for SYNCH byte receiving after reset is 500 ms instead of 1 second.
	1.1	Rev B	Limitations: – CPU clock is set to HSI/1 (16 MHz) when bootloader resumes Fixed limitation: – Readout protection option bit is checked – Timeout for SYNCH byte receiving after reset is 500 ms instead of 1 second.
	1.2	Rev Z	Improvement: – EMC lockup protection Fixed limitations: – CPU clock is set back to its reset state when bootloader resumes – Timeout for SYNCH byte receiving after reset has been changed to 1 second.
STM8L-8K	1.0	Rev Z	Initial version Improvement: – EMC lock up protection

## Revision history

**Table 16. Document revision history**

Date	Revision	Changes
15-Dec-2008	1	Initial release
10-Nov-2009	2	<p>Added STM8L15xxx device and changed title of document to STM8L/S.</p> <p>Updated point 2 of the <i>Flow chart description</i>.</p> <p>Added <i>3.1.1: LINUART/UARTs in "reply" mode settings</i>.</p> <p>Added <i>Table 7: Bootloader codes</i>.</p> <p>Updated <i>Section 4.8: Software model (STM8A/L/S)</i> concerning modification of the RAM content.</p> <p>Added <i>4.8.1: RAM erase/write routines</i> sections.</p> <p>Added <i>Appendix A: How to upload ROP protected device</i>.</p> <p>Added <i>Appendix B: Bootloader entry points</i>.</p> <p>Added <i>Appendix C: SPI peripheral timing options</i>.</p> <p>Added <i>Appendix D: PC software support</i>.</p> <p>Edited English and rewrote several sections.</p>
24-Aug-2010	3	<p>Document merged with the STM8A bootloader user manual (UM0500) and consequently, every section was reworked. The sections: "LINUART settings" and "Memory model (STM8A)" were removed. Additional technical changes include:</p> <p>Updated point 5 of the <i>Flow chart description</i>.</p> <p><i>Section 2.1: Bootloader activation</i>: added important note about CLK_CKDIVR register bug on STM8L devices.</p> <p><i>Table 5: Serial interfaces associated with STM8 devices</i>: added devices which have no bootloader.</p> <p><i>Section 3.3: CAN settings</i>: replaced the transmit and receive settings from the "STM8L/S" to the "STM8S".</p> <p><i>4.8.1: RAM erase/write routines</i>: removed sentence "this is necessary because the routines are consecutive with no empty memory locations between them".</p> <p><i>Section 5: Error management</i>: added new explanatory text.</p> <p><i>Section 6: Programming time</i>: replaced note.</p>

Table 16. Document revision history (continued)

Date	Revision	Changes
17-Mar-2011	4	<p>Changed hexadecimal notation for bytes and addresses.</p> <p>Removed external crystal frequency condition of 16 MHz for CAN transfer rate.</p> <p>Replaced device part numbers par STM8 groups.</p> <p>Added <a href="#">Table 1: STM8 subfamilies featuring a bootloader</a> and <a href="#">Table 2: STM8 subfamilies without bootloader</a> in <a href="#">Section 2: Bootloader introduction</a>.</p> <p>Updated <a href="#">Table 3: Bootloader versions for which bootloader activation flowchart is valid</a> to replace device by STM8 groups, and add STM8L-8K. In <a href="#">Section 2.1: Bootloader activation</a>, removed important note concerning STM8L15xxx devices, and clarified differences between previous and newer bootloader.</p> <p>Updated <a href="#">Table 5: Serial interfaces associated with STM8 devices</a>.</p> <p>Added STM8L-8K and STM8L-64K in <a href="#">Table 9: STM8 sector codes</a>.</p> <p>Updated RAM erase/write routine names in <a href="#">Section 4.8.1: RAM erase/write routines</a>.</p> <p>Added STM8L-8K and updated Reset, BL option and ROP checks for all the other groups in <a href="#">Table 14: Bootloader entry points</a>.</p> <p>Removed 16 Kbyte devices in <a href="#">Section C.2: Modified erase/write RAM routines</a>.</p> <p>Added <a href="#">Appendix E: Bootloader UART limitation</a>.</p> <p>Added the device versions corresponding to each bootloader version, as well as the limitation for bootloader version 1.2 of STM8S/A-32K in <a href="#">Table 15: Description of limitation, improvements and added features</a>.</p>
12-Dec-2011	5	<p>Updated STM8S/A-128K and STM8S/A-32K device revisions in <a href="#">Appendix F: Limitations and improvements versus bootloader versions</a>.</p> <p>Updated disclaimer on last page.</p>

**Please Read Carefully:**

Information in this document is provided solely in connection with ST products. STMicroelectronics NV and its subsidiaries ("ST") reserve the right to make changes, corrections, modifications or improvements, to this document, and the products and services described herein at any time, without notice.

All ST products are sold pursuant to ST's terms and conditions of sale.

Purchasers are solely responsible for the choice, selection and use of the ST products and services described herein, and ST assumes no liability whatsoever relating to the choice, selection or use of the ST products and services described herein.

No license, express or implied, by estoppel or otherwise, to any intellectual property rights is granted under this document. If any part of this document refers to any third party products or services it shall not be deemed a license grant by ST for the use of such third party products or services, or any intellectual property contained therein or considered as a warranty covering the use in any manner whatsoever of such third party products or services or any intellectual property contained therein.

**UNLESS OTHERWISE SET FORTH IN ST'S TERMS AND CONDITIONS OF SALE ST DISCLAIMS ANY EXPRESS OR IMPLIED WARRANTY WITH RESPECT TO THE USE AND/OR SALE OF ST PRODUCTS INCLUDING WITHOUT LIMITATION IMPLIED WARRANTIES OF MERCHANTABILITY, FITNESS FOR A PARTICULAR PURPOSE (AND THEIR EQUIVALENTS UNDER THE LAWS OF ANY JURISDICTION), OR INFRINGEMENT OF ANY PATENT, COPYRIGHT OR OTHER INTELLECTUAL PROPERTY RIGHT.**

**UNLESS EXPRESSLY APPROVED IN WRITING BY TWO AUTHORIZED ST REPRESENTATIVES, ST PRODUCTS ARE NOT RECOMMENDED, AUTHORIZED OR WARRANTED FOR USE IN MILITARY, AIR CRAFT, SPACE, LIFE SAVING, OR LIFE SUSTAINING APPLICATIONS, NOR IN PRODUCTS OR SYSTEMS WHERE FAILURE OR MALFUNCTION MAY RESULT IN PERSONAL INJURY, DEATH, OR SEVERE PROPERTY OR ENVIRONMENTAL DAMAGE. ST PRODUCTS WHICH ARE NOT SPECIFIED AS "AUTOMOTIVE GRADE" MAY ONLY BE USED IN AUTOMOTIVE APPLICATIONS AT USER'S OWN RISK.**

Resale of ST products with provisions different from the statements and/or technical features set forth in this document shall immediately void any warranty granted by ST for the ST product or service described herein and shall not create or extend in any manner whatsoever, any liability of ST.

ST and the ST logo are trademarks or registered trademarks of ST in various countries.

Information in this document supersedes and replaces all information previously supplied.

The ST logo is a registered trademark of STMicroelectronics. All other names are the property of their respective owners.

© 2011 STMicroelectronics - All rights reserved

STMicroelectronics group of companies

Australia - Belgium - Brazil - Canada - China - Czech Republic - Finland - France - Germany - Hong Kong - India - Israel - Italy - Japan - Malaysia - Malta - Morocco - Philippines - Singapore - Spain - Sweden - Switzerland - United Kingdom - United States of America

[www.st.com](http://www.st.com)